

# PRICE LIST

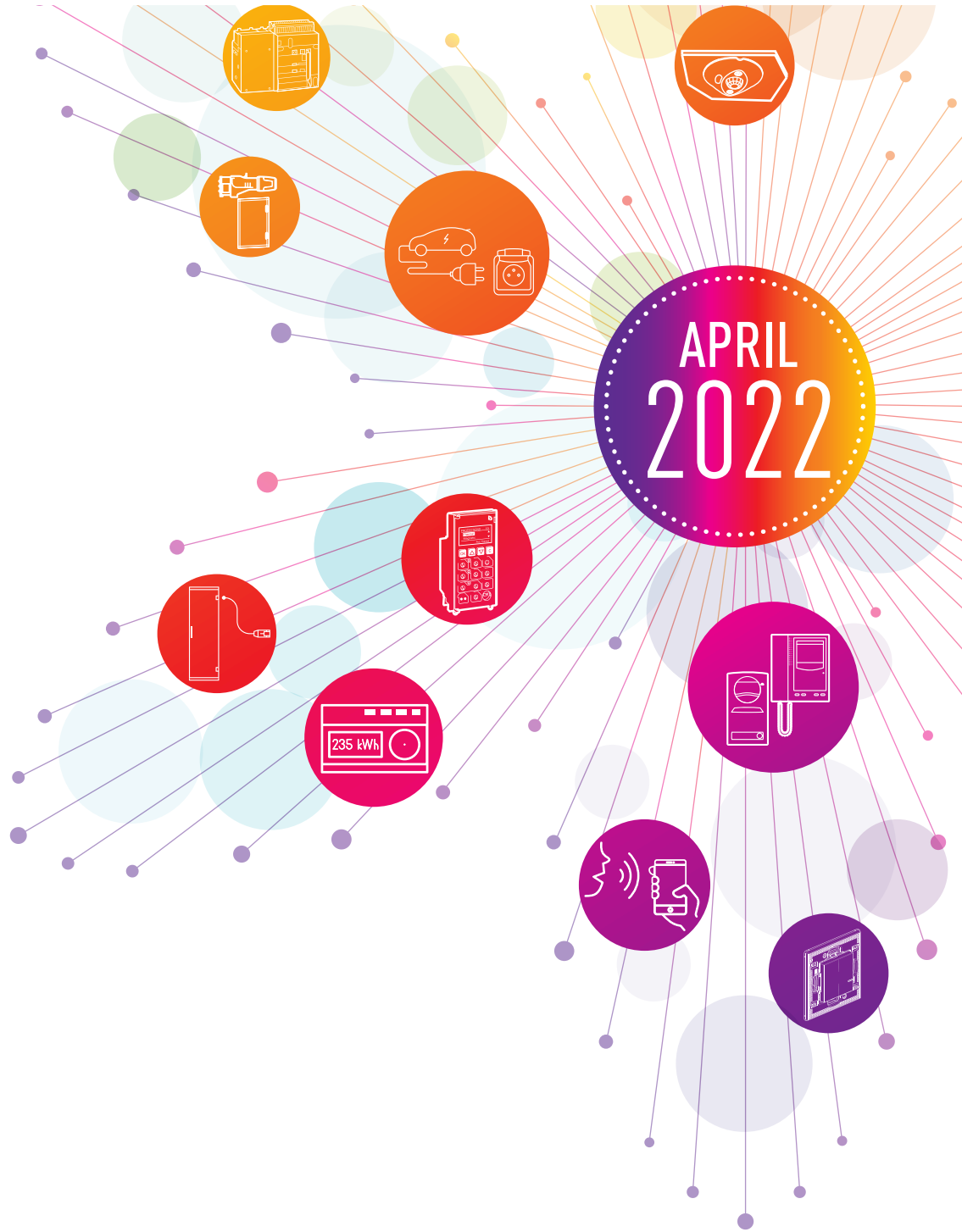

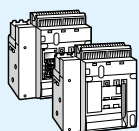

### Power



**P. 15**  
DMX³ ACB from  
630 A to 6300 A  
Fixed version

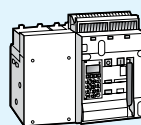

**P. 16**  
DMX³ ACB from  
630 A to 6300 A  
Draw out version



**P. 17**  
DMX³ ACB,  
Protection Units,  
Terminal Adapters &  
Conversion Kits

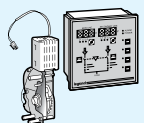

**P. 21**  
Auxilliaris &  
Accessories



**P. 24**  
DRX MCCBs

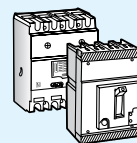

**P. 25-39**  
DPX³ MCCBs &  
Accessories

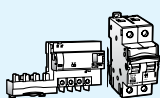

**P. 56-57**  
E-Communicating  
Infrastructure



**P. 60**  
Power Supply

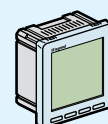

**P. 63-64**  
EMDX³  
Digital Meter

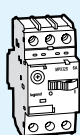

**P. 78-81**  
MPX³ & MPX³  
Accessories

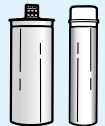

**P. 83**  
ALPX³ resin filled  
capacitors standard  
and heavy duty  
440 V, 480 V & 525 V



**P. 83**  
Alpican gas filled  
capacitors  
Heavy duty 440 V



### Protection, Isolation, Controlling, Signalling, Metering.

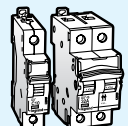

**P. 88-91**  
DX3³ MCB  
& Isolators

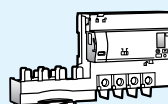

**P. 93-94**  
DX3 RCD  
add-on module  
with metering

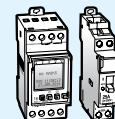

**P. 95**  
DX3 Time switches  
and Contactors

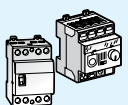

**P. 100**  
Lexic dimmer and  
Power contactors



**P. 100**  
Lexic  
Time delay  
relay

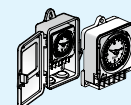

**P. 101**  
Time switches and  
Accessories

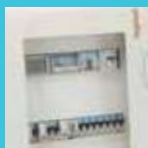

### Distribution Boards



**P. 105**  
Ekinox³  
SPN & ETPN DBs

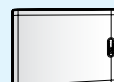

**P. 106**  
Ekinox³  
TPN DB-VTPN

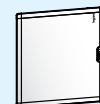

**P. 106**  
Ekinox³  
TPN DB-Phase Selector



**P. 108**  
Ekinox³  
Cable end box,  
Meter box, PPT Kit  
& Accessories



**P. 109**  
Ekinox³ DBs  
Plexo 3 boxes for  
DX³ and Accessories



### Arteor™ Wiring Accessories

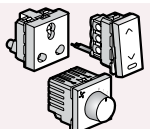

**P. 124-125**  
Switches, Push buttons,  
Dimmers, Regulators, Indian  
standard sockets square white

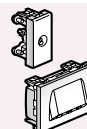

**P. 125**  
USB Chargers, Data & voice, Hotel funtions,  
Audio Video, Energy plugs, USB Charger,  
RJ11 Telephone Sockets, Information outlets

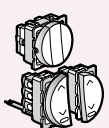

**P. 129**  
Square - Champagne  
mechanisms  
Switches, Push  
buttons, Dimmers &  
Regulators.



**P. 129**  
Switches,  
Push buttons



**P. 130**  
Square -Champagne  
mechanisms USB Chargers, Hotel  
funtions, RJ11 Telephone Sockets,  
Information outlets

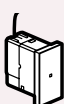

**P. 144**  
Arteor™  
Connected Home

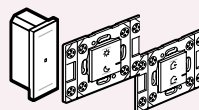

**P. 144**  
White, Magnesium & Champagne Mechanism-  
connected light switches, outlets, gateway pack,  
wireless controls & wireless scene switches

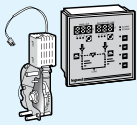

**P. 18**  
Auxiliaries &  
Accessories

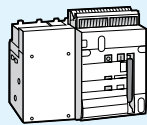

**P. 20**  
DMX SP 2500 ACB  
630 A to 2500 A  
Fixed version Draw-  
out version

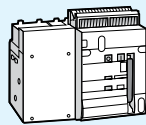

**P. 20**  
DMX SP 2500 Switch  
disconnectors 630 A  
to 2500 A Fixed ver-  
sion Draw-out version



**P. 21**  
DMX SP 2500  
Protection Units

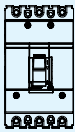

**P. 42**  
DRX 125  
MCCBs



**P. 43-47**  
DRX 125,  
250<sup>HP</sup> & 630  
MCCBs & Accessories

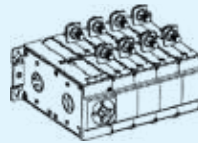

**P. 55**  
DSX

NEW!

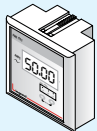

**P. 66-68**  
PMX  
Digital Panel Meter

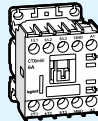

**P. 70-72**  
CTX<sup>3</sup> contactors

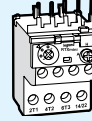

**P. 73-74**  
RTX<sup>3</sup>  
thermal relays

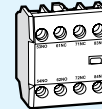

**P. 75-76**  
CTX<sup>3</sup>  
accessories



**P. 83**  
Alpx<sup>3</sup> box type  
capacitors standard  
and heavy duty  
440 V



**P. 83**  
Reactors and  
power factor con-  
trollers

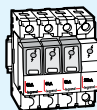

**P. 96-99**  
SPD

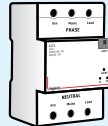

**P. 99**  
ACCL

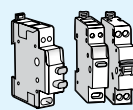

**P. 99-100**  
DX3 changeover  
switches,  
Push buttons and  
Indicators



**P. 101**  
Time lag switches



**P. 107**  
Ekinox<sup>3</sup>  
TPN DB-  
7 Segment DBs



**P. 107**  
Ekinox<sup>3</sup>  
P17 Tempra Plug  
& Socket DBs



**P. 107**  
Ekinox<sup>3</sup> Metra  
Plug & Socket  
DBs



**P. 108**  
Ekinox<sup>3</sup>  
Metal  
Enclosures



**P. 126**  
Accessories  
Square Mechanism

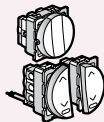

**P. 126**  
Square magnesium  
Indian standard sockets,  
USB Chargers,  
Data & voice

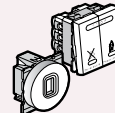

**P. 127-128**  
Square magnesium-USB Chargers,  
Data & voice, Hotel functions,  
Audio Video, Energy plugs, USB  
Charger, RJ11 Telephone Sockets,  
Information outlets

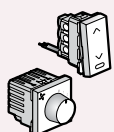

**P.130-131**  
Round - champagne  
mechanisms  
Switches, Push buttons,  
Dimmers & Regulators,  
Plates, accessories.

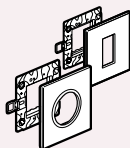

**P. 133-137**  
Square cover plates,  
Round cover plates

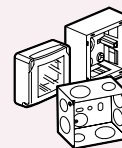

**P. 137**  
Plastic surface,  
Metal flush boxes,  
Plexo boxes &  
Accessories

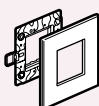

**P. 145-147**  
COVER PLATES  
White, Pearl Aluminium, Graphite, Magnesium, Champagne, Dark Bronze, Mirror, Silver  
Baroque, Dark Baroque, Metal, Wood & Signature cover with overmoulded frame



**P. 147**  
Cover plates without frame  
& Accessories



### Myrius® NextGen Accessories

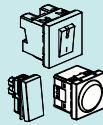

**P. 150**  
Classic White Switches,  
Push buttons, Dimmers  
& Regulators, Emergency  
Light



**P. 151-152**  
Hospitality Functions,  
Sockets, Electronic  
Function

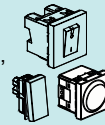

**P. 152-153**  
Electronic Function,  
Switches - Charcoal  
Grey



**P. 154-155**  
Plate With Frame  
White, Ice White, Ice Black, Pearl Champagne,  
Sonic Silver, Dark Fade, Interlude, Trinity,  
Luminar & Stellar



**P. 155-156**  
Metal flush boxes



### Myrius® NextGen IoT Accessories

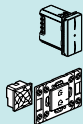

**P. 162**  
Myrius NextGen  
Connected Home White & Charcoal Grey Mechanism  
Light Switches, Connected outlets, Curtain/Roller binder,  
Gateway pack, Wireless control, Wireless Scene Switches



### Myrius™ Wiring Accessories



White mechanisms

**P. 170-171**  
Switches,  
Push buttons, Sockets,  
Power units and  
Dimmer and regulators

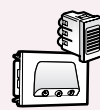

**P. 171**  
Indicators,  
Skirting light, Indicators,  
Buzzers, Sensors and  
Remote unit



**P. 171**  
Hospitality  
functions, Sockets  
& connectors,  
Data & voice

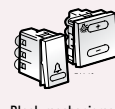

Black mechanisms

**P. 173**  
Dimmer &  
regulators, Switches  
& Push buttons

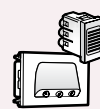

**P. 174**  
Indicators, Skirting  
light, Indicators,  
Buzzers & Sensor



**P. 174**  
Remote unit,  
Hospitality functions,  
Sockets & connectors,  
Data & voice



### Mylinc™ Wiring Accessories

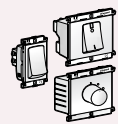

White mechanisms

**P. 179**  
Mylinc switches,  
Dimmers and  
Accessories USB  
charger and remote unit

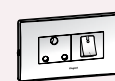

**P. 179**  
Mylinc energy  
sockets, Power  
units and MCBs

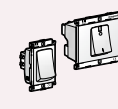

Grey mechanisms

**P. 180**  
Mylinc switches,  
Dimmers, USB  
charger, Remote unit  
& Accessories



**P. 181**  
Mylinc energy  
sockets,  
Power units and  
MCBs

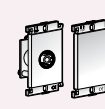

**P. 181**  
Mylinc TV,  
RJ 11 Telephone  
Sockets &  
Accessories



### Lyncus™ Wiring Accessories



White mechanisms

**P. 185**  
Switches,  
Push buttons,  
Standard Sockets



**P. 185**  
Dimmer and  
regulators,  
Hospitality  
Functions



**P. 185-186**  
Data voice,  
Pre terminated  
audio video  
connectors



Chic Grey Mechanism

**P. 186-187**  
Switches,  
Push buttons,  
Dimmer and regulators,  
Accessories



**P. 187**  
Hospitality  
Functions,  
Data voice,  
Pre terminated



**P. 187**  
Audio Video  
Connectors, USB  
chargers: Combi  
Sockets + USB



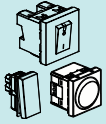

**P. 152-153**  
Mechanisms Charcoal  
Grey Switches, Push  
buttons, Dimmers &  
Regulators, Emergency Light

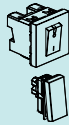

**P. 153**  
Mechanisms Charcoal Grey  
Hospitality Functions,  
Sockets, Electronic Function



**P. 156**  
Plastic surface  
boxes & Metal  
surface boxes



**P. 156**  
Mechanism  
AntiBacterial &  
Accessories



**P. 163-165**  
Cover Frame  
White, Ice White, Ice Black, Pearl Champagne,  
Sonic Silver, Dark Fade, Interlude, Trinity,  
Luminar & Stellar



**P. 165**  
Cover plates without frame  
& Accessories



**P. 171**  
USB chargers  
and Audio  
& video connectors

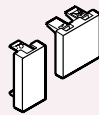

**P. 172**  
Anti-Bacterial Switches  
and Accessories



**P. 174**  
USB chargers and  
Audio & video con-  
nectors

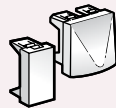

**P. 174**  
Volume control-  
ler, Protectors  
and Accessories,  
Modular MCBs

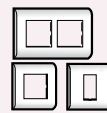

**P. 174-175**  
White & Black  
plastic plates

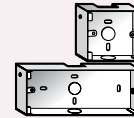

**P. 175**  
Flush mounting &  
Surface boxes

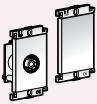

**P. 179-180**  
Mylinc TV and  
RJ 11 telephone  
sockets and  
Accessories

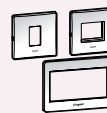

**P. 180**  
Mylinc  
Modular Plates -  
White



**P. 181**  
Mylinc modular plates-  
Matt Grey, Pearl white,  
Champagne, Silver Alu,  
Dark Bronze

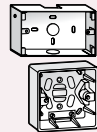

**P. 182**  
Mylinc white  
surrounds,  
Flush & Surface  
boxes



**P. 186**  
USB Chargers:  
Combi sockets + USB,  
Wireless charger



**P.186**  
sound diffusion  
and loud speakers, Universal  
dimmers, touch switches, reading  
lights



**P. 188**  
Plate & Frame  
White, Chic grey, Brushed  
silver, Alu sunset,  
Champagne, Matt silver

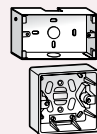

**P. 188**  
Metal Flush box &  
Plastic surface  
boxes



**Britzy™  
Wiring  
Accessories**

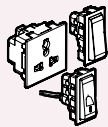

**P. 191**  
Britzy Switches,  
sockets and push  
buttons

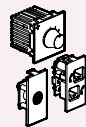

**P. 191**  
Britzy Data & voice,  
television sockets,  
dimmers & regulators  
& accessories

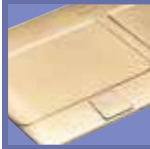

**Cable  
Management  
System and  
Accessories**

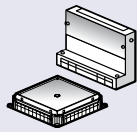

**P. 200**  
Raceways & junction  
boxes for screed  
floors PVC, Metal  
and Accessories

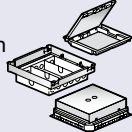

**P. 200-201**  
Floor boxes for  
raised floor, Screed  
floor and tile/marble,  
Support Plates

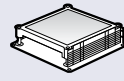

**P. 201-204**  
Heavy Duty in-screed  
floor box, Floor Boxes  
3 module, Floor access  
unit for raised floors



**P. 211**  
Selection Chart:  
DLP Mini Trunking  
Systems

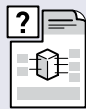

**P. 212-213**  
Selection Chart :  
DLP aluminium  
Trunking system

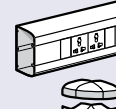

**P. 214**  
Snap-On Trunking  
45 mm, Routing  
sections and  
Accessories



**VDI  
Structured  
Cabling**

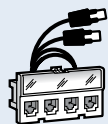

**P. 219**  
LCS³,  
cat. 8 Patch  
Panels

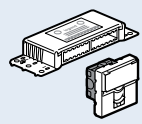

**P. 219**  
LCS³,  
cat. 8 Cables  
and Cords



**P. 222-223**  
LCS³,  
cat. 6A Patch  
panels, RJ 45,  
Cables and Cords

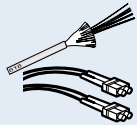

**P. 230**  
LCS³,  
Audio/Video  
patch panel chord  
cables

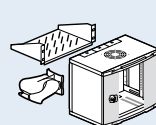

**P. 230**  
Modular Panels  
cassettes for LCS³  
fibre optic drawers

**P. 231-232**  
LCS³ pigtails, case  
and quick-connect  
connectors



**Movement  
Detectors and  
Door Phones**

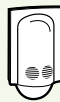

**P. 237**  
Movement  
detectors



**P. 237**  
Video door entry  
system



**P17 Tempra Pro,  
Hypra and  
Plugs & Sockets**

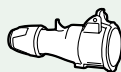

**P. 244-245**  
P17 Tempra Pro  
sockets



**P. 246**  
P17 Tempra Pro  
for refrigerated  
container



**P. 246**  
Hypra industrial  
plugs and sockets



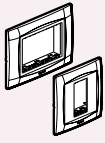

**P. 192**

Britzy white plate, warm orange silver, herb beige, urban bronze, orange chrome with frame

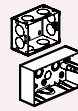

**P. 193**

Britzy Flush & surface mounting boxes



**P. 204-208**

Pop-up type flush-mounting boxes, Power & Data desk grommets



**P. 208**

Flush Mounting Power & data module

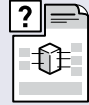

**P. 208-209**

Selection Chart: Snap-On trunking



**P. 210-211**

Selection chart: DLP PVC adaptable trunking system

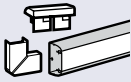

**P. 214-215**

DLP PVC Trunking System, Trunking, Mini-Trunking and Accessories

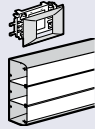

**P. 216**

DLP-S PVC Trunking system and Trunking Accessories

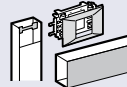

**P. 216-217**

DLP Aluminium Adaptable Trunking System, Aluminium Snap-on columns

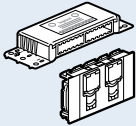

**P. 223-226**

LCS³, cat. 6 Patch Panels, RJ 45, Cables and Cords

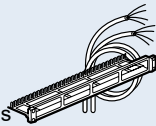

**P. 226-227**

LCS³, cat. 5e Patch panels, Cables and Cords, RJ45

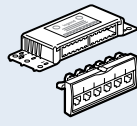

**P. 228**

LCS³, cat. Splitter sockets, adapters and accessories



**P. 229-230**

LCS³, Audio/Video Preterminated sockets

**P. 232-233**

LCS³ High Density and Very High Density drawers and cassettes

**P. 234**

LCS³ Preterminated fibre optic and cable solutions

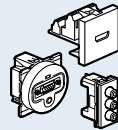

**P. 235**

9" fibre optic drawers, LCS³ fibre optic blocks

**P. 235**

Patch chords



# Intelligent EI

## SMARTNESS THAT MAKES A DIFFERENCE

Our Intelligent EI is a fully interconnected electrical system that enables reliable delivery of energy to customers through real-time, automated control systems. An overlay of information-oriented software and services on top of the existing infrastructure provides more reasons and opportunities for customer participation to make informed decisions and better operational efficiency.

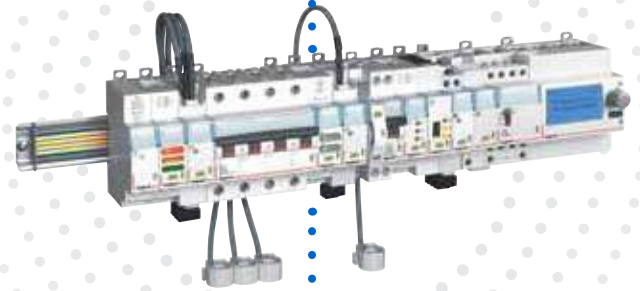

**PROGRAMMING  
AND DISPLAY**



**COMMUNICATION**



**MEASUREMENT**



**SIGNALLING**



**CONTROL**



Scan to know more about the product.



**SIGNALLING  
AND CONTROL**





# CX<sup>3</sup>

## A SMART PLATFORM FOR YOUR ENERGY MANAGEMENT NEEDS

The CX<sup>3</sup> EMS energy management system allows the precise management and use of energy within a building. It allows full control of all activities and help supervises facility more effectively.



**WEB SERVER**



**ACBs**



**MCCB'S**



**MEASURING UNIT**



**WATER**



**GAS**



Scan to know more about the product.



3RD PARTY BMS/SCADA

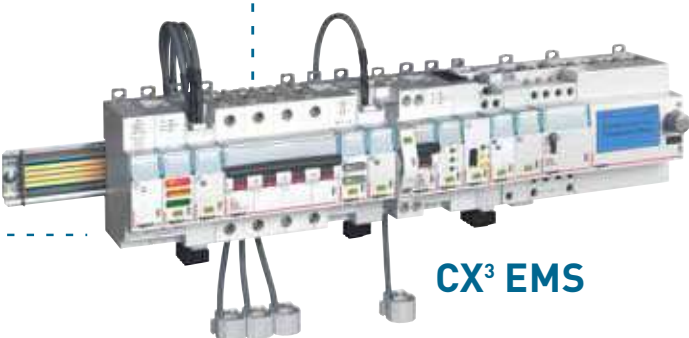

CX<sup>3</sup> EMS



ENERGY  
METER



ELECTRICITY

# XL<sup>3</sup> DO

FUTURE READY  
ENCLOSURES DESIGNED  
TO OUTPERFORM  
ALL CONDITIONS

6300A  
Integrated Switchboard Solutions



Scan to know more about  
the product.



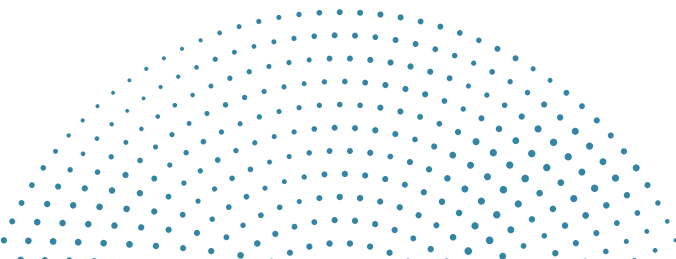

**Advantages with XL3 D0:**



Design verified assembly in accordance with IEC 61439, guarantees safe investment.



Internal arc withstand ensures additional personal safety.



Design Ambient of 50°C to withstand the harsh Indian conditions.



Available in IP43/54 configuration ensures further safety.



Be Connected and take control through communication capable products.



Sufficient cabling space with real front access foresees maintenance.



The wide choice of columns offers an unlimited number of XL3 D0 enclosure configurations, so you can optimise and adapt your solutions to different types of environment.



Compact solution guarantees space saving.

AIR CIRCUIT BREAKERS

# DMX<sup>3</sup>

EFFICIENT  
PROTECTION  
UP TO 6300 A



## MP6 LSI/LSI<sub>g</sub> TOUCH SCREEN PROTECTION UNIT<sup>®</sup>



LEDs INDICATING CORRECT  
OPERATION, PRE-ALARM  
AND ALARM FOR OVERLOAD  
AND TEMPERATURE

SETTINGS LOCK

ON BUTTON

MINI USB  
PORT FOR PC  
CONNECTION

**Innovative and user friendly touch screen tripping units**



Scan to know more about  
the product.



## DMX<sup>3</sup> Air Circuit Breakers



- Range – 630 A to 6300 A
- Three Optimum Frame Sizes
- Breaking Capacities of 50 kA, 65 kA & 100 kA
- Advanced Self Powered Electronic Protection Units
- Options for LSI and LSIG Trip Units
  - L : Ir – 0.4 to 1 In , tr – 5 to 30 sec
  - S : Isd – 1.5 to 10 Ir , tsd – 0.1 to 1 sec
  - I : Ii – 2 to 15 In
  - G : 0.2 to 1 In , tg – 0.1 to 1 sec
- Options of LCD and Touch Screen Multi Colour Displays
- Neutral Overload Protection – OFF-50 %-100 %
- Communication Ready
- In Built Temperature Protection
- Rotatable Terminals for Horizontal/Vertical Orientation
- Fast Operation
- Options to install various safety interlock
- Internal Battery for Trip Units
- Individual fault diagnosis
- Individual Fault Counter & Historical Trip Record
- Option to add 6 Programmable Digital Relay Contacts with Time Delay Changeover
- Option to Measure Current, Voltage, Frequency, Power, Energy, Power Factor and internal battery voltage
- Advanced Functions of Logical Selectivity, Reverse Power, Current Unbalance, Overvoltage, Undervoltage, Voltage Unbalance, Under Frequency, Over Frequency & Phase Reversal

Type and frame size	Rated Current (A)	3P			4P		
		Cat.Nos	MRP*/₹/Unit	Pack	Cat.Nos	MRP*/₹/Unit	Pack

### Fixed Version

DMX <sup>3</sup> - N 2500, Icu 50 kA Frame - 1	630 A	0286 20	■	1	0286 30	■	1
	800 A	0286 21	■	1	0286 31	■	1
	1000 A	0286 22	■	1	0286 32	■	1
	1250 A	0286 23	■	1	0286 33	■	1
	1600 A	0286 24	■	1	0286 34	■	1
	2000 A	0286 25	■	1	0286 35	■	1
	2500 A	0286 26	■	1	0286 36	■	1
DMX <sup>3</sup> -N 4000 Icu 50 kA Frame - 2	3200 A	0286 27	■	1	0286 37	■	1
	4000 A	0286 28	■	1	0286 38	■	1
DMX <sup>3</sup> - H 2500, Icu 65 kA Frame - 1	630 A	0286 40	■	1	0286 50	■	1
	800 A	0286 41	■	1	0286 51	■	1
	1000 A	0286 42	■	1	0286 52	■	1
	1250 A	0286 43	■	1	0286 53	■	1
	1600 A	0286 44	■	1	0286 54	■	1
	2000 A	0286 45	■	1	0286 55	■	1
	2500 A	0286 46	■	1	0286 56	■	1
DMX <sup>3</sup> -H 4000 Icu 65 kA Frame - 2	3200 A	0286 47	■	1	0286 57	■	1
	4000 A	0286 48	■	1	0286 58	■	1
DMX <sup>3</sup> - L 2500, Icu 100 kA Frame - 2	630 A	0286 60	■	1	0286 70	■	1
	800 A	0286 61	■	1	0286 71	■	1
	1000 A	0286 62	■	1	0286 72	■	1
	1250 A	0286 63	■	1	0286 73	■	1
	1600 A	0286 64	■	1	0286 74	■	1
	2000 A	0286 65	■	1	0286 75	■	1
	2500 A	0286 66	■	1	0286 76	■	1
DMX <sup>3</sup> -L 4000 Icu 100 kA Frame - 2	3200 A	0286 67	■	1	0286 77	■	1
	4000 A	0286 68	■	1	0286 78	■	1
DMX <sup>3</sup> -L 6300 Icu 100 kA Frame - 3	5000 A	0289 50	■	1	0289 60	■	1
	6300 A	0289 51	■	1	0289 61	■	1

■ Price available on request.

\* MRP - Maximum Retail Price Inclusive of all taxes including GST.

Bold Cat.Nos are products normally available with Legrand (India) Stockists. Cat.Nos that are not bold - delivery within 4 - 8 weeks from the date of order. Bold packing quantity is our mandatory packing. Orders to be placed by Legrand (India) Stockist in multiples of the same.



0286 37



0286 56

## DMX<sup>3</sup> Air Circuit Breakers

Type and frame size	Rated Current (A)	3P			4P		
		Cat.Nos	MRP*/₹/Unit	Pack	Cat.Nos	MRP*/₹/Unit	Pack

### Draw - Out Version

DMX <sup>3</sup> - N 2500, Icu 50 kA Frame - 1	630 A	0287 20	■	1	0287 30	■	1
	800 A	0287 21	■	1	0287 31	■	1
	1000 A	0287 22	■	1	0287 32	■	1
	1250 A	0287 23	■	1	0287 33	■	1
	1600 A	0287 24	■	1	0287 34	■	1
	2000 A	0287 25	■	1	0287 35	■	1
	2500 A	0287 26	■	1	0287 36	■	1
DMX <sup>3</sup> -N 4000 Icu 50 kA Frame - 2	3200 A	0287 27	■	1	0287 37	■	1
	4000 A	0287 28	■	1	0287 38	■	1
DMX <sup>3</sup> - H 2500, Icu 65 kA Frame - 1	630 A	0287 40	■	1	0287 50	■	1
	800 A	0287 41	■	1	0287 51	■	1
	1000 A	0287 42	■	1	0287 52	■	1
	1250 A	0287 43	■	1	0287 53	■	1
	1600 A	0287 44	■	1	0287 54	■	1
	2000 A	0287 45	■	1	0287 55	■	1
	2500 A	0287 46	■	1	0287 56	■	1
DMX <sup>3</sup> -H 4000 Icu 65 kA Frame - 2	3200 A	0287 47	■	1	0287 57	■	1
	4000 A	0287 48	■	1	0287 58	■	1
DMX <sup>3</sup> - L 2500, Icu 100 kA Frame - 2	630 A	0287 60	■	1	0287 70	■	1
	800 A	0287 61	■	1	0287 71	■	1
	1000 A	0287 62	■	1	0287 72	■	1
	1250 A	0287 63	■	1	0287 73	■	1
	1600 A	0287 64	■	1	0287 74	■	1
	2000 A	0287 65	■	1	0287 75	■	1
	2500 A	0287 66	■	1	0287 76	■	1
DMX <sup>3</sup> -L 4000 Icu 100 kA Frame - 2	3200 A	0287 67	■	1	0287 77	■	1
	4000 A	0287 68	■	1	0287 78	■	1
DMX <sup>3</sup> -L 6300 Icu 100 kA Frame - 3	5000 A	0289 52	■	1	0289 62	■	1
	6300 A	0289 53	■	1	0289 63	■	1



0287 56

### Switch Disconnecter (Trip Free Switches) from 1250 to 6300 A

#### Fixed Version

DMX <sup>3</sup> -I 2500 Frame - 1	1250 A	0286 83	■	1	0286 93	■	1
	1600 A	0286 84	■	1	0286 94	■	1
	2000 A	0286 85	■	1	0286 95	■	1
	2500 A	0286 86	■	1	0286 96	■	1
DMX <sup>3</sup> -I 4000 Frame - 2	3200 A	0286 87	■	1	0286 97	■	1
	4000 A	0286 88	■	1	0286 98	■	1
DMX <sup>3</sup> -I 6300 Frame - 3	6300 A	0289 70	■	1	0289 71	■	1



0286 96

#### Draw - Out Version

DMX <sup>3</sup> -I 2500 Frame - 1	1250 A	0287 83	■	1	0287 93	■	1
	1600 A	0287 84	■	1	0287 94	■	1
	2000 A	0287 85	■	1	0287 95	■	1
	2500 A	0287 86	■	1	0287 96	■	1
DMX <sup>3</sup> -I 4000 Frame - 2	3200 A	0287 87	■	1	0287 97	■	1
	4000 A	0287 88	■	1	0287 98	■	1
DMX <sup>3</sup> -I 6300 Frame - 3	6300 A	0289 77	■	1	0289 78	■	1



0287 96

\* MRP - Maximum Retail Price Inclusive of all taxes including GST.  
■ Price available on request.

Bold Cat.Nos are products normally available with Legrand (India) Stockists.  
Cat.Nos that are not bold - delivery within 4 - 8 weeks from the date of order.  
Bold packing quantity is our mandatory packing. Orders to be placed by Legrand (India) Stockist in multiples of the same.

## DMX<sup>3</sup>

### Electronic Protection Units

Cat.Nos	Description	MRP*/₹/Unit	Pack
---------	-------------	-------------	------

#### Electronic Protection Units MP4

0288 01	Electronic Protection Unit with LCD screen with Im, tm, lr, tr and li adjustments on the front	■	1
0288 02	Electronic Protection Unit with LCD screen with Im, tm, lr, tr, li, lg and tg adjustments on the front	■	1



0288 02

#### Electronic Protection Units MP6

0288 03	Electronic Protection Unit with Touch screen with Im, tm, lr, tr and li, adjustments on the front	■	1
0288 04	Electronic Protection Unit with Touch screen with Im, tm, lr, tr, li, lg and tg adjustments on the front	■	1



0288 03

#### Accessories for Electronic Protection Units

0288 10	External neutral CT for DMX <sup>3</sup> 6300	■	1
0288 11 <sup>(1)</sup>	External neutral CT	■	1

Type and frame size	3P			4P		
	Cat.Nos	MRP*/₹/Unit	Pack	Cat.Nos	MRP*/₹/Unit	Pack

#### Fixed Version

DMX <sup>3</sup> 2500, fixed version, frame - 1	0288 84	■	1	0288 85	■	1
	0288 82	■	1	0288 83	■	1
DMX <sup>3</sup> 4000, DMX <sup>3</sup> 6300 fixed version, frame - 2 & 3	0288 92	■	1	0288 93	■	1
DMX <sup>3</sup> 2500 draw-out version, Frame - 1	0288 96	■	1	0288 97	■	1
DMX <sup>3</sup> 4000, DMX <sup>3</sup> 6300 draw-out version, fram - 2 & 3	0288 94	■	1	0288 95	■	1
DMX <sup>3</sup> 2500, draw-out version, frame-1 suitable for Aluminium	0288 96A	■	1	0288 97A	■	1
DMX <sup>3</sup> 4000, DMX <sup>3</sup> 6300 draw-out version, frame - 2&3, suitable for Aluminium	0288 94A	■	1	0288 95A	■	1



0288 84



0288 82



0288 96

#### Spreaders

DMX <sup>3</sup> 2500, fixed version, frame - 1	0289 02	■	1	0288 87	■	1
	0288 88	■	1	0288 89	■	1
	0288 90	■	1	0288 91	■	1



0288 91

#### Equipment for conversion of a fixed device into draw-out device

##### Bases (cradle) for Draw-Out Device

DMX <sup>3</sup> /DMX <sup>3</sup> -I 2500, frame - 1	0289 02	■	1	0289 03	■	1
DMX <sup>3</sup> /DMX <sup>3</sup> -I 4000, frame - 2	0289 04	■	1	0289 05	■	1
DMX <sup>3</sup> /DMX <sup>3</sup> -I 6300, frame - 3	0289 13	■	1	0289 14	■	1

##### Transformation kit for Draw-Out Version

DMX <sup>3</sup> /DMX <sup>3</sup> -I 2500, frame - 1	0289 09	■	1	0289 10	■	1
DMX <sup>3</sup> /DMX <sup>3</sup> -I 4000, frame - 2	0289 11	■	1	0289 12	■	1
DMX <sup>3</sup> /DMX <sup>3</sup> -I 6300, frame - 3	0289 15	■	1	0289 16	■	1

\* MRP - Maximum Retail Price Inclusive of all taxes including GST.

■ Price available on request.

(1) Optional accessories to be ordered while ordering electronic protection unit and DMX<sup>3</sup> air circuit breakers for factory assembly

Bold Cat.Nos are products normally available with Legrand (India) Stockists. Cat.Nos that are not bold - delivery within 4 - 8 weeks from the date of order. Bold packing quantity is our mandatory packing. Orders to be placed by Legrand (India) Stockist in multiples of the same.

## DMX<sup>3</sup> Auxiliaries and Accessories

Cat.Nos	Description	MRP* ₹ / Unit	Pack
---------	-------------	------------------	------

### Control and signalling auxiliaries

#### Shunt trip

0288 48	24 V~/=	■	1
0288 49	48 V~/=	■	1
0288 50	110 V~/=	■	1
0288 51	230 V~/=	■	1
0288 52	415 V~	■	1



0288 51

#### Undervoltage Releases

0288 55	24 V~/=	■	1
0288 56	48 V~/=	■	1
0288 57	110 V~/=	■	1
0288 58	230 V~/=	■	1
0288 59	415 V~	■	1



0288 58

#### Undervoltage Releases with Delay

0288 62	110 V~/=	■	1
0288 63	230 V~/=	■	1

#### Motor operators

0288 34	24 V~/=	■	1
0288 35	48 V~/=	■	1
0288 36	110 V~/=	■	1
0288 37	230 V~/=	■	1
0288 38	415 V~	■	1



0288 37

#### Closing coils

0288 41	24 V~/=	■	1
0288 42	48 V~/=	■	1
0288 43	110 V~/=	■	1
0288 44	230 V~/=	■	1
0288 45	415 V~	■	1



0288 44

### Locking

#### Key locking in "open" position

0288 31	Ronis lock (key included)	■	1
0288 29	Ronies key barrel	■	1
0288 30	Profalux lock (key included)	■	1
0288 28	2 hole support frame for Ronis locks	■	1

## DMX<sup>3</sup> Auxiliaries and Accessories

Cat.Nos	Description	MRP* ₹ / Unit	Pack
---------	-------------	------------------	------

### Locking

#### Key locking in the draw-out position

0288 33	Ronis lock (key included)	■	1
0288 32	Profalux lock (key included)	■	1



0288 32  
+  
0288 33

#### Door locking

0288 20	Left-hand and right-hand side mounting	■	1
---------	--	---	---

#### Padlocks in "open" position

0288 21	Padlocking system for ACB	■	1
0288 24	Padlocking for button	■	1
0288 26	Padlocking system for shutters	■	1

### Automation Control Unit

4226 81	Standard unit	■	1
4226 82	Advanced unit	■	1
4226 89▼	Communication module	■	1



4226 82

### Equipment for supply invertors

0288 64	Interlock for DMX <sup>3</sup> 2500	■	1
0288 65	Interlock for DMX <sup>3</sup> 4000	■	1
0288 66	Interlock for DMX <sup>3</sup> 6300	■	1



0288 64

### Cable interlock

0289 20	Type 1 (2600 mm)	■	1
0289 21	Type 2 (3000 mm)	■	1
0289 22	Type 3 (3600 mm)	■	1
0289 23	Type 4 (4000 mm)	■	1
0289 24	Type 5 (4600 mm)	■	1
0289 25	Type 6 (5600 mm)	■	1

### Accessories

0288 25	Rating mis-insertion device	■	1
0288 23	Operations counter	■	1
0288 13	Inserted / test / Draw-out Contact	■	1
0288 14	Contact "ready to close" with charged springs	■	1
0288 15	Set of additional signalling contacts	■	1
0288 16	Signal Contact for Auxiliaries	■	1
0288 22	Door sealing IP 40	■	1
0288 79	Lifting plate	■	1

\* MRP - Maximum Retail Price Inclusive of all taxes including GST.  
■ Price available on request.  
▼ For communication add 4226 82 + 4226 89

Bold Cat.Nos are products normally available with Legrand (India) Stockists. Cat.Nos that are not bold - delivery within 4 - 8 weeks from the date of order. Bold packing quantity is our mandatory packing. Orders to be placed by Legrand (India) Stockist in multiples of the same.

# DMX

# SP-2500

A SUPERIOR ACB IN  
THE 630 A - 2500 A RANGE



## OPTIMIZED

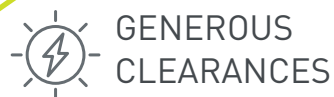

GENEROUS  
CLEARANCES

## SMART



ELECTRONIC RELEASES  
OFFERING PRECISE  
PROTECTION



IN - BUILT TEMPERATURE  
PROTECTION

## EFFICIENT



EASY INSTALLATION



EASY MAINTENANCE



Scan to know more about  
the product.



## DMX SP 2500 Air Circuit Breakers



- Range – 630 A to 2500 A
- Single Frame Size
- Options of Fixed and Drawout Versions
- Options of Manual & Electrical Versions
- Icu=Ics=Icw(1s)=50 kA
- Compact Dimensions
- Advanced Self Powered Electronic Protection Units
  - MP2 & MP4
- MP2 - Electronic PU with LSI/LSIg + Neutral O/L + Over Temperature Protection
- MP4 - Electronic PU with LSI/LSIg + Neutral O/L + Over Temperature Protection
  - + LCD Display with Current Metering + 10 Trip History + 10 Alarms + Logical Selectivity
- Options of LSI and LSIg Protections
  - L : I<sub>r</sub> – 0.4 to 1 I<sub>n</sub>, t<sub>r</sub> – 5 to 30 sec
  - S : I<sub>sd</sub> – 1.5 to 10 I<sub>r</sub>, t<sub>sd</sub> – 0.1 to 1 sec
  - I : I<sub>li</sub> – 2 to 15 I<sub>n</sub>
  - G : I<sub>g</sub> – 0.2 to 1 I<sub>n</sub>, t<sub>g</sub> – 0.1 to 1 sec
- Neutral Overload Protection - OFF-50 %-100 %
- In Built Temperature Protection
- Rotatable Terminals for Horizontal/Vertical Orientation
- Fast Operation
- Options to install various safety interlock



6695 26



6695 31

Type and frame size	Rated Current (A)	3P			4P		
		Cat.Nos	MRP*/₹/Unit	Pack	Cat.Nos	MRP*/₹/Unit	Pack

### Fixed Version

DMX SP 2500 Icu = 50 kA	630 A	6695 24	109246	1	6695 30	152168	1
	800 A	6695 25	109246	1	6695 31	152168	1
	1000 A	6695 26	117048	1	6695 32	163874	1
	1250 A	6695 27	138508	1	6695 33	191180	1
	1600 A	6695 28	160838	1	6695 34	210624	1
	2000 A	6695 29	192618	1	0286 35	259224	1
	2500 A	6695 76	243896	1	6695 77	283446	1

### Drawout version

DMX SP 2500 Icu = 50 kA	630 A	6695 36	140456	1	6695 42	183374	1
	800 A	6695 37	140456	1	6695 43	183374	1
	1000 A	6695 38	148266	1	6695 44	195088	1
	1250 A	6695 39	169728	1	6695 45	222398	1
	1600 A	6695 40	191470	1	6695 46	241254	1
	2000 A	6695 41	237428	1	6695 47	282266	1
	2500 A	6695 78	276854	1	6695 79	329588	1

### Switch Disconnectors / Trip Free Switches Fixed version

DMX SP 2500	630 A	6695 48	109246	1	6695 54	152168	1
	800 A	6695 49	109246	1	6695 55	152168	1
	1000 A	6695 50	117048	1	6695 56	163874	1
	1250 A	6695 51	138508	1	6695 57	191180	1
	1600 A	6695 52	160838	1	6695 58	210624	1
	2000 A	6695 53	192618	1	6695 59	253048	1
	2500 A	6695 80	243896	1	6695 81	283446	1

### Drawout version

DMX SP 2500	630 A	6695 60	140456	1	6695 66	183374	1
	800 A	6695 61	140456	1	6695 67	183374	1
	1000 A	6695 62	148266	1	6695 68	195088	1
	1250 A	6695 63	169728	1	6695 69	222398	1
	1600 A	6695 64	191470	1	6695 70	241254	1
	2000 A	6695 65	237428	1	6695 71	282266	1
	2500 A	6695 82	276854	1	6695 83	329588	1



6695 68

\* MRP - Maximum Retail Price Inclusive of all taxes including GST.

Bold Cat.Nos are products normally available with Legrand (India) Stockists. Cat.Nos that are not bold - delivery within 4 - 8 weeks from the date of order. Bold packing quantity is our mandatory packing. Orders to be placed by Legrand (India) Stockist in multiples of the same.

## DMX SP 2500

### Electronic Protection Units

Cat.Nos	Description	MRP* ₹ / Unit	Pack
---------	-------------	------------------	------

#### Electronic Protection Units

0281 67	Electronic Protection Unit MP2 LSI	24216	1
0281 68	Electronic Protection Unit MP2 LSIG	29800	1
0281 65	Electronic Protection Unit MP4 LSI	29440	1
0281 66	Electronic Protection Unit MP4 LSIG	36800	1

#### Auxiliaries Accessories

##### Motor operator

0281 20	24 V~/=	34354	1
0281 21	48 V~/=	34354	1
0281 22	110-130 V~/=	34354	1
0281 23	220-250 V~/=	34354	1
0281 24	415-440 V~	34354	1

##### Closing coil

0281 26	24 V~/=	5788	1
0281 27	48 V~/=	5788	1
0281 28	110-130 V~/=	5788	1
0281 29	220-250 V~/=	5788	1
0281 30	415-440 V~	5788	1

##### Shunt release

0281 31	24 V~/=	5788	1
0281 32	48 V~/=	5788	1
0281 33	110-130 V~/=	5788	1
0281 34	220-250 V~/=	5788	1
0281 35	415-440 V~	5788	1

##### Undervoltage release

0281 36	24 V~/=	7820	1
0281 37	48 V~/=	7820	1
0281 38	110-130 V~/=	7820	1
0281 39	220-250 V~/=	7820	1
0281 40	415-440 V~	7820	1

##### Time Delay Module for Undervoltage release

0288 62	110 V~/=	■	1
0288 63	230 V~/=	6612	1

#### Mechanical Accessories

##### Phase barriers / Insulated shields

6696 00	Fix Version 3P DMX SP	■	1
6696 01	Fix Version 4P DMX SP	■	1
6696 02	Draw-out Version 3P DMX SP	1986	1
6696 03	Draw-out Version 4P DMX SP	2650	1

■ Price available on request.

\* MRP - Maximum Retail Price Inclusive of all taxes including GST.

## DMX SP 2500

### Auxiliaries Accessories

Cat.Nos	Description	MRP* ₹ / Unit	Pack
---------	-------------	------------------	------

#### Key lock

0281 78	Keylock in open position (1 lock 1 Ronis random) Frame 2500	4848	1
0281 79	Keylock in open position (1 lock 1 Ronis type "A") Frame 2500	4848	1
0281 80	Keylock in open position (1 lock 1 Ronis type "B") Frame 2500	4848	1
0281 81	Keylock in open position - Profalux DMX SP	4848	1
0281 82	Keylock ins./test/drawnout - Profalux DMX SP	4848	1
0281 83	Keylock ins./test/drawnout - Ronis DMX SP	4848	1
0281 84	Door lock for both right & left handle Frame 2500	4848	1
0281 87	Inserted/test/drawnout lock button	2236	1

#### Terminals

0288 84	Real terminals - flat connections with bars-3P	19332	1
0288 82	Real terminals - vertical connections with bars-4P	21478	1
0288 85	Real terminals - flat connections with bars-3P	25134	1
0288 83	Real terminals - vertical connections with bars-4P	28994	1
0288 96	Real terminals - vertical or horizontal connection with bars to be fixed onto plate-3P	11160	1
0288 97	Real terminals - vertical or horizontal connection with bars to be fixed onto plate-4P	14880	1

#### Additional Accessories

0281 88	Mechanical Counter	3728	1
0281 77	Padlock for Button	1486	1
6696 05	Enternal Neutral	7236	1
0281 73	Signalling Contact inserted-test-D/O	2918	1
0281 74	AUX Ready to close-charged springs	2978	1
0281 75	Module with 6 aux contacts	22350	1
0281 90	Mechanical Interlock two device	11950	1

Bold Cat.Nos are products normally available with Legrand (India) Stockists. Cat.Nos that are not bold - delivery within 4 - 8 weeks from the date of order. Bold packing quantity is our mandatory packing. Orders to be placed by Legrand (India) Stockist in multiples of the same.

# DPX<sup>3</sup>

PRECISE PROTECTION  
AND MEASUREMENT  
UP TO 1600 A



## TOTAL SELECTIVITY FOR OPTIMUM CONTINUITY OF SERVICE

### DYNAMIC SELECTIVITY

Electronic DPX<sup>3</sup> units have 2-position adjustment:

- Low for normal selectivity level
- High for high selectivity level

When electronic circuit breakers are set to High there is a slight tripping delay, enabling a high level of selectivity to be obtained, even for the highest short-circuit currents.

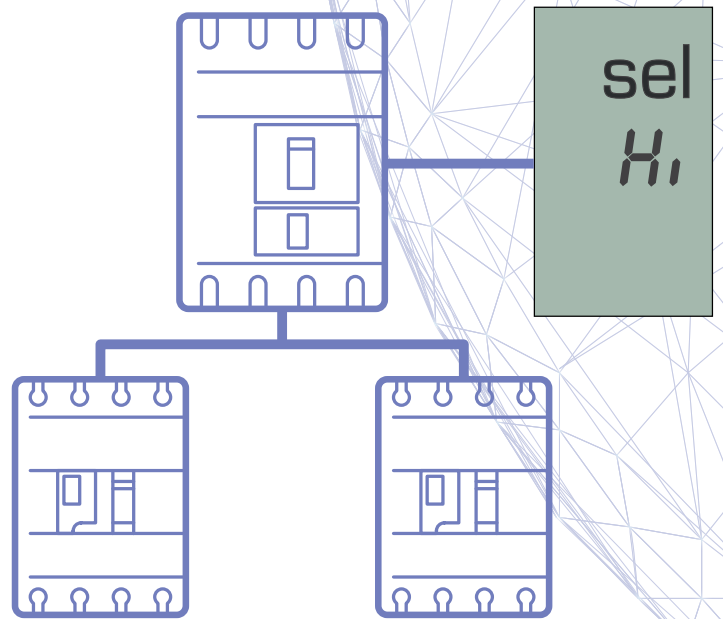

DPX<sup>3</sup> 160



DPX<sup>3</sup> 250



DPX<sup>3</sup> 630



DPX<sup>3</sup> 1600



Scan to know more about  
the product.



NEW FUNCTIONS  
TO SIMPLIFY USE

## Integrated measurement From 40 to 1600 A

The measurement data can also be viewed remotely on a PC equipped with supervision software, via a communication interface.

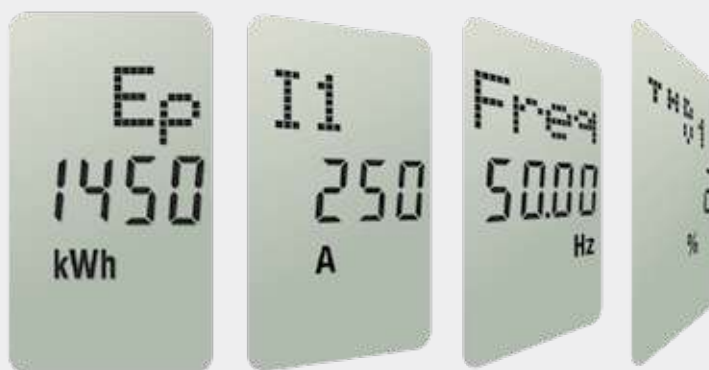



## DRX™ MCCB

Type and frame size	Rated Current (A)	Poles	Cat.Nos	MRP* ₹ / Unit	Pack
---------------------	-------------------	-------	---------	---------------	------

### DRX MCCBs

DRX 100	63 A	3 Pole	0270 39	3444	1/12
Icu = 10 kA	75 A	3 Pole	0270 07	3444	1/12
	100 A	3 Pole	0270 08	3444	1/12
	63 A	4 Pole	0270 29	5056	1/12
	75 A	4 Pole	0270 17	5056	1/12
	100 A	4 Pole	0270 18	5056	1/12

Description	Cat.Nos	MRP* ₹ / Unit	Pack
-------------	---------	---------------	------

### DIN rail adaptor

DRX 100	0271 87	458	1
---------	---------	-----	---

### Rotary handles - Direct

DRX 100	6687 70	1170	1
---------	---------	------	---

### Rotary handles - vary-depth

DRX 100	6687 71	1850	1
---------	---------	------	---

### Padlocking support for operating handle

DRX 100	0271 80	158	1
---------	---------	-----	---

### Connection accessories

Set of 2 shields for 3 pole	0271 81	112	1
-----------------------------	---------	-----	---

### Sealable terminal shields (moulded shrouds)

For DRX 100 - 3 pole	0271 83	1496	1
For DRX 100 - 4 pole	0271 84	1466	1

### Cage terminals

For DRX 100 - 3 pole	0271 71	306	1
For DRX 100 - 4 pole	0271 73	300	1

### Electrical accessories

Block with 1 auxiliary (1 AUX)	0271 40	1000	1
Block with 1 alarm (1 AL)	0271 41	1000	1
Block with 1 auxiliary + 1 alarm (1 AUX + 1 AL)	0271 42	1750	1

### Current shunt coils

200/277 V~ and =	0271 54	2160	1
380/480 V~ and =	0271 55	2160	1

### Undervoltage release coils

200/240 V~	0271 64	3000	1
380/415 V~	0271 65	3000	1

### DRX spreader links

3 Links set for TP	6250 10	240	1
4 Links set for FP	6250 11	340	1

### Metal one way enclosures for MCCB

Cat.Nos	Description	No. of modules	MRP* ₹ / Unit	Pack
5078 05	DRX 100 MCCB enclosure-TP	3	2662	1
5078 06	DRX 100 MCCB enclosure-FP	3	2510	1

\* MRP - Maximum Retail Price Inclusive of all taxes including GST.

# BUSBAR TRUNKING SYSTEM

FOR INDUSTRIAL, COMMERCIAL, RESIDENTIAL AND SERVICE SECTOR BUILDINGS

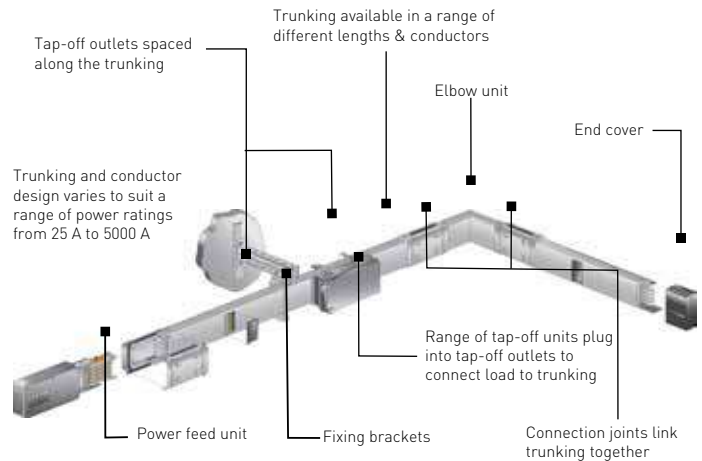

### Exclusive features

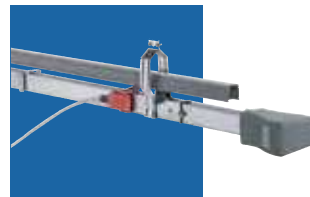

#### Low Power (25 A, 40 A, 63 A)

- Lighting busway
- 2, 4 & 6 pole
- IP 55 protection
- Tap off units at each 0.5 mt interval
- Copper busbars



#### Medium Power (63 A - 1000 A)

- Riser mains application
- IP 40, IP 52, IP 55 protection
- Tap off units at each 1 mt interval
- Aluminium & copper busbars



#### Cast Resin Busbar (630 A - 6300 A)

- Fully insulated with epoxy resin
- IP68 suited for outdoor
- Industrial plants, Petrochemical plants, Chemical plants in areas with risk of flooding.

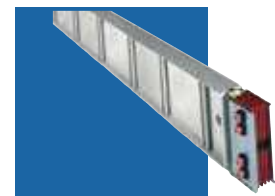

#### Super Compact (630 A - 6300 A)

- Sandwich type construction
- IP 65 protection
- Tap off boxes at each 1 mt interval
- Aluminium & copper busbars



Scan to know more about the product.

Bold Cat.Nos are products normally available with Legrand (India) Stockists. Cat.Nos that are not bold - delivery within 4 - 8 weeks from the date of order. Bold packing quantity is our mandatory packing. Orders to be placed by Legrand (India) Stockist in multiples of the same.



## DPX<sup>3</sup> MCCB

### DPX<sup>3</sup> MCCB with Thermal Magnetic Protection Unit

- Range: 16A – 1250A, Ics=100%Icu, Four Optimum Frames
  - Thermal Adjustable – 0.8 to 1In, Magnetic Adjustable\*\* – 5 to 10In
  - Breaking Capacity# – 16kA, 25kA, 36kA, 50kA, 70kA & 100kA
  - Option for In built or add on module for Earth Leakage Protection##
    - Adjustable sensitivity: 0.03 - 0.3 - 1 - 3 A
    - Adjustable tripping: 0 - 0.3 - 1 - 3s
  - Suitable for Isolation
- \*\* Fixed at 10In for DPX<sup>3</sup> 160  
 # Refer Catalogue for frame wise data  
 ## For DPX<sup>3</sup> 160, DPX<sup>3</sup> 250 and DPX<sup>3</sup> 630 Only

Category	Type	Rated Current (A)	3P			4P		
			Cat.Nos	MRP*/₹/Unit	Pack	Cat.Nos	MRP*/₹/Unit	Pack

#### Thermal Magnetic : O/L & S/C protection

16 KA	DPX <sup>3</sup> 160	16	4200 00	7084	1	4200 10	9442	1
		25	4200 01	7084	1	4200 11	9442	1
		40	4200 02	7084	1	4200 12	9442	1
		63	4200 03	7084	1	4200 13	9442	1
		80	4200 04	7084	1	4200 14	9442	1
		100	4200 05	7084	1	4200 15	9442	1
		125	4200 06	7664	1	4200 16	9502	1
		160	4200 07	9882	1	4200 17	12440	1
25 KA	DPX <sup>3</sup> 160	16	4200 40	8280	1	4200 50	11510	1
		25	4200 41	8280	1	4200 51	11510	1
		40	4200 42	8280	1	4200 52	11510	1
		63	4200 43	8280	1	4200 53	11510	1
		80	4200 44	8280	1	4200 54	11510	1
		100	4200 45	8280	1	4200 55	11510	1
		125	4200 46	11980	1	4200 56	14538	1
		160	4200 47	15568	1	4200 57	18510	1
	DPX <sup>3</sup> 250	200	4202 08	21616	1	4202 18	26118	1
		250	4202 09	25058	1	4202 19	33766	1
36 KA	DPX <sup>3</sup> 160	16	4200 80	10494	1	4200 90	13094	1
		25	4200 81	10494	1	4200 91	13094	1
		40	4200 82	10494	1	4200 92	13094	1
		63	4200 83	10494	1	4200 93	13094	1
		80	4200 84	10494	1	4200 94	13094	1
		100	4200 85	10494	1	4200 95	13094	1
		125	4200 86	11794	1	4200 96	16054	1
		160	4200 87	15856	1	4200 97	18658	1
	DPX <sup>3</sup> 250	200	4202 38	27242	1	4202 48	34444	1
		250	4202 39	30232	1	4202 49	36888	1
	DPX <sup>3</sup> 630	320	4220 01	36328	1	4220 06	41260	1
		400	4220 02	36328	1	4220 07	42164	1
		500	4220 03	43716	1	4220 08	51998	1
		630	4220 04	43716	1	4220 09	53326	1
	DPX <sup>3</sup> 1600	800	4222 52	66378	1	4222 57	74680	1
		1000	4222 53	86640	1	4222 58	109530	1
		1250	4222 54	123796	1	4222 59	131766	1

■ Price available on request.

\* MRP - Maximum Retail Price Inclusive of all taxes including GST.

Bold Cat.Nos are products normally available with Legrand (India) Stockists. Cat.Nos that are not bold - delivery within 4 - 8 weeks from the date of order. Bold packing quantity is our mandatory packing. Orders to be placed by Legrand (India) Stockist in multiples of the same.

## DPX<sup>3</sup> MCCB

### DPX<sup>3</sup> MCCB with Thermal Magnetic Protection Unit

Category	Type	Rated Current (A)	3P			4P		
			Cat.Nos	MRP*/₹/Unit	Pack	Cat.Nos	MRP*/₹/Unit	Pack
<b>Thermal Magnetic : O/L &amp; S/C protection</b>								
50 KA	DPX <sup>3</sup> 160	16	4201 20	13978	1	4201 30	17610	1
		25	4201 21	13978	1	4201 31	17610	1
		40	4201 22	13978	1	4201 32	17610	1
		63	4201 23	13978	1	4201 33	17610	1
		80	4201 24	13978	1	4201 34	17610	1
		100	4201 25	13978	1	4201 35	17610	1
		125	4201 26	18316	1	4201 36	21106	1
		160	4201 27	20616	1	4201 37	23984	1
	DPX <sup>3</sup> 250	200	4202 68	33006	1	4202 78	41700	1
		250	4202 69	34848	1	4202 79	43370	1
	DPX <sup>3</sup> 630	320	4220 15	39442	1	4220 20	48072	1
		400	4220 16	40292	1	4220 21	48072	1
		500	4220 17	49880	1	4220 22	62990	1
		630	4220 18	49880	1	4220 23	64584	1
	DPX <sup>3</sup> 1600	800	4222 64	73084	1	4222 69	85790	1
		1000	4222 65	114002	1	4222 70	128694	1
		1250	4222 66	167476	1	4222 71	171590	1
	70 KA	DPX <sup>3</sup> 250	100	4206 05	28920	1	4206 15	31922
160			4206 07	36132	1	4206 17	44926	1
200			4206 08	44490	1	4206 18	54744	1
250			4206 09	47278	1	4206 19	56988	1
DPX <sup>3</sup> 630		320	4220 29	46142	1	4220 34	57146	1
		400	4220 30	46152	1	4220 35	57146	1
		500	4220 31	60188	1	4220 36	77536	1
		630	4220 32	63254	1	4220 37	77536	1
DPX <sup>3</sup> 1600		800	4222 76	118530	1	4222 81	137414	1
		1000	4222 77	179492	1	4222 82	254140	1
		1250	4222 78	183880	1	4222 83	293052	1

\* MRP - Maximum Retail Price Inclusive of all taxes including GST.  
 ■ Price available on request.

Bold Cat.Nos are products normally available with Legrand (India) Stockists. Cat.Nos that are not bold - delivery within 4 - 8 weeks from the date of order. Bold packing quantity is our mandatory packing. Orders to be placed by Legrand (India) Stockist in multiples of the same.

## DPX<sup>3</sup> MCCB

### DPX<sup>3</sup> MCCB with Thermal Magnetic Protection Unit

Category	Type	Rated Current (A)	3P			4P				
			Cat.Nos	MRP*/₹/Unit	Pack	Cat.Nos	MRP*/₹/Unit	Pack		
<b>Thermal Magnetic + Electronic earth leakage module</b>										
16 KA	DPX <sup>3</sup> 160	16	-	-	-	4200 30	31876	1		
		25	-	-	-	4200 31	31876	1		
		40	-	-	-	4200 32	31876	1		
		63	-	-	-	4200 33	31876	1		
		80	-	-	-	4200 34	31876	1		
		100	-	-	-	4200 35	31876	1		
		125	-	-	-	4200 36	33624	1		
		160	-	-	-	4200 37	42660	1		
25 KA	DPX <sup>3</sup> 160	16	-	-	-	4200 70	40360	1		
		25	-	-	-	4200 71	40360	1		
		40	-	-	-	4200 72	40360	1		
		63	-	-	-	4200 73	40360	1		
		80	-	-	-	4200 74	40360	1		
		100	-	-	-	4200 75	40360	1		
		125	-	-	-	4200 76	40374	1		
		160	-	-	-	4200 77	47662	1		
	DPX <sup>3</sup> 250	100	-	-	-	4202 25	48892	1		
		160	-	-	-	4202 27	51396	1		
		200	-	-	-	4202 28	53384	1		
		250	-	-	-	4202 29	57088	1		
		36 KA	DPX <sup>3</sup> 160	16	-	-	-	4201 10	49092	1
				25	-	-	-	4201 11	49092	1
40	-			-	-	4201 12	49092	1		
63	-			-	-	4201 13	49092	1		
80	-			-	-	4201 14	49092	1		
100	-			-	-	4201 15	49092	1		
125	-			-	-	4201 16	49356	1		
160	-			-	-	4201 17	58708	1		
DPX <sup>3</sup> 250	100	-	-	-	4202 55	51038	1			
	160	-	-	-	4202 57	59448	1			
	200	-	-	-	4202 58	62352	1			
	250	-	-	-	4202 59	66676	1			
50 KA	DPX <sup>3</sup> 160	16	-	-	-	4201 50	56846	1		
		25	-	-	-	4201 51	56846	1		
		40	-	-	-	4201 52	56846	1		
		63	-	-	-	4201 53	56846	1		
		80	-	-	-	4201 54	56846	1		
		100	-	-	-	4201 55	56846	1		
		125	-	-	-	4201 56	60570	1		
		160	-	-	-	4201 57	64826	1		
	DPX <sup>3</sup> 250	100	-	-	-	4202 85	61248	1		
		160	-	-	-	4202 87	70894	1		
		200	-	-	-	4202 88	74698	1		
		250	-	-	-	4202 89	79364	1		

■ Price available on request.

\* MRP - Maximum Retail Price Inclusive of all taxes including GST.

Bold Cat.Nos are products normally available with Legrand (India) Stockists. Cat.Nos that are not bold - delivery within 4 - 8 weeks from the date of order. Bold packing quantity is our mandatory packing. Orders to be placed by Legrand (India) Stockist in multiples of the same.

## DPX<sup>3</sup> MCCB

### DPX<sup>3</sup> MCCB with Electronic S2<sup>®</sup> (LSI)<sup>®</sup> Protection Unit

- Range: 40A – 1600A, Ics=100%Icu, Three Optimum Frames
- Protection against overloads:
  - Ir adjustable from 0.4 to 1 x In
  - tr adjustable from 3 to 30s#
- Protection against short circuits:
  - I<sub>sd</sub> adjustable from 1.5 to 10 x Ir
  - t<sub>sd</sub> adjustable from 0 to 0.5s
- Inbuilt Instantaneous Protection:
  - Ii# – Fixed
- Option for In built or add on module for Earth Leakage Protection##
  - Adjustable sensitivity: 0.03 - 0.3 - 1 - 3 A
  - Adjustable tripping: 0 - 0.3 - 1 - 3s
- Breaking Capacity# – 25kA, 36kA, 50kA, 70kA & 100kA
- In built Display for Current Metering with accuracy of class 1
- Internal Battery with battery measure function
- Communication Ready via COMM Port
- Logical Selectivity Ready (Zone Selective Interlocking)
- Dynamic Selectivity as per Selectivity Charts
- In Built USB Port for Software Diagnosis
- Suitable for Isolation

Category	Type	Rated Current (A)	3P			4P		
			Cat.Nos	MRP*/₹/Unit	Pack	Cat.Nos	MRP*/₹/Unit	Pack

### Electronic S2

25 KA	DPX <sup>3</sup> 250	40	4203 02	23060	1	4203 12	30278	1
		100	4203 05	23060	1	4203 15	30278	1
		160	4203 07	29878	1	4203 17	35732	1
		250	4203 09	38962	1	4203 19	48300	1
36 KA	DPX <sup>3</sup> 250	40	4203 32	25068	1	4203 42	30896	1
		100	4203 35	25068	1	4203 45	30896	1
		160	4203 37	31412	1	4203 47	41918	1
		250	4203 39	42086	1	4203 49	48428	1
	DPX <sup>3</sup> 630	320	4220 57	46292	1	4220 62	57784	1
		400	4220 58	46292	1	4220 63	56574	1
		500	4220 59	51798	1	4220 64	69478	1
		630	4220 60	52882	1	4220 65	70940	1
DPX <sup>3</sup> 1600	800	4223 00	88102	1	4223 06	108796	1	
	1000	4223 01	134900	1	4223 07	199058	1	
	1250	4223 02	162552	1	4223 08	242120	1	
	1600	4223 03	201170	1	4223 09	270210	1	
50 KA	DPX <sup>3</sup> 250	40	4203 62	29798	1	4203 72	39712	1
		100	4203 65	29798	1	4203 75	39068	1
		160	4203 67	35982	1	4203 77	42964	1
		250	4203 69	48014	1	4203 79	58114	1
	DPX <sup>3</sup> 630	320	4220 67	52564	1	4220 72	67038	1
		400	4220 68	52564	1	4220 73	67038	1
		500	4220 69	61418	1	4220 74	76774	1
		630	4220 70	61418	1	4220 75	76774	1
	DPX <sup>3</sup> 1600	800	4223 12	103804	1	4223 18	139974	1
		1000	4223 13	144380	1	4223 19	201226	1
		1250	4223 14	175200	1	4223 20	255378	1
		1600	4223 15	245368	1	4223 21	288858	1

\* MRP - Maximum Retail Price Inclusive of all taxes including GST.  
 ■ Price available on request.

Bold Cat.Nos are products normally available with Legrand (India) Stockists. Cat.Nos that are not bold - delivery within 4 - 8 weeks from the date of order. Bold packing quantity is our mandatory packing. Orders to be placed by Legrand (India) Stockist in multiples of the same.

## DPX<sup>3</sup> MCCB

### DPX<sup>3</sup> MCCB with Electronic S2<sup>#</sup> (LSI)<sup>#</sup> Protection Unit

Category	Type	Rated Current (A)	3P			4P		
			Cat.Nos	MRP*/₹/Unit	Pack	Cat.Nos	MRP*/₹/Unit	Pack

#### Electronic S2

70 KA	DPX <sup>3</sup> 250	40	4206 35	37690	1	4206 45	49860	1
		100	4206 37	38068	1	4206 47	49860	1
		160	4206 38	49854	1	4206 48	57272	1
		250	4206 39	56920	1	4206 49	73460	1
	DPX <sup>3</sup> 630	320	4220 77	66640	1	4220 82	86022	1
		400	4220 78	66640	1	4220 83	86022	1
		500	4220 79	75824	1	4220 84	96696	1
		630	4220 80	75824	1	4220 85	96696	1
	DPX <sup>3</sup> 1600	800	4223 24	135430	1	4223 30	171386	1
		1000	4223 25	189782	1	4223 31	270854	1
		1250	4223 26	227274	1	4223 32	315992	1
		1600	4223 27	305520	1	4223 33	376166	1

#### Electronic S2 + Electronic earth leakage module

25 kA	DPX <sup>3</sup> 250	40	-	-	-	4203 22	69174	1
		100	-	-	-	4203 25	68836	1
		160	-	-	-	4203 27	73842	1
		250	-	-	-	4203 29	86836	1
36 kA	DPX <sup>3</sup> 250	40	-	-	-	4203 52	71902	1
		100	-	-	-	4203 55	71902	1
		160	-	-	-	4203 57	79128	1
		250	-	-	-	4203 59	92482	1
50 kA	DPX <sup>3</sup> 250	40	-	-	-	4203 82	80102	1
		100	-	-	-	4203 85	80102	1
		160	-	-	-	4203 87	86616	1
		250	-	-	-	4203 89	100886	1
70 kA	DPX <sup>3</sup> 250	40	-	-	-	4206 55	101150	1
		100	-	-	-	4206 57	101150	1
		160	-	-	-	4206 58	114302	1
		250	-	-	-	4206 59	156576	1

■ Price available on request.

\* MRP - Maximum Retail Price Inclusive of all taxes including GST.

Bold Cat.Nos are products normally available with Legrand (India) Stockists. Cat.Nos that are not bold - delivery within 4 - 8 weeks from the date of order. Bold packing quantity is our mandatory packing. Orders to be placed by Legrand (India) Stockist in multiples of the same.



## DPX<sup>3</sup> MCCB

### DPX<sup>3</sup> MCCB with Electronic Sg (LSIg) Protection Unit

- Range: 40A – 1600A, Ics=100%Icu, Three Optimum Frames
- Protection against Overloads:
  - Ir adjustable from 0.4 to 1 x In
  - tr adjustable from 3 to 30s#
- Protection against Short Circuits:
  - Isd adjustable from 1.5 to 10 x Ir
  - tsd adjustable from 0 to 0.5s
- Inbuilt Instantaneous Protection:
  - li# – Fixed
- Protection against Ground Fault:
  - Ig adjustable from 0.2 to 1 In & OFF
  - tg adjustable from 0.1 to 1s
- Breaking Capacity#– 25kA, 36kA, 50kA, 70kA & 100kA
- In built Display for Current Metering with high accuracy of class 1
- Internal Battery with battery measure function
- Communication Ready via COMM Port
- Logical Selectivity Ready (Zone Selective Interlocking)
- Dynamic Selectivity as per Selectivity Charts
- In Built USB Port for Software Diagnosis
- Switchable Thermal Memory
- Suitable for Isolation

Category	Type	Rated Current (A)	3P			4P		
			Cat.Nos	MRP*/₹/Unit	Pack	Cat.Nos	MRP*/₹/Unit	Pack

#### Electronic Sg

25 KA	DPX <sup>3</sup> 250	40	4205 02	41466	1	4205 12	46416	1
		100	4205 05	41466	1	4205 15	46416	1
		160	4205 07	46136	1	4205 17	51152	1
		250	4205 09	51004	1	4205 19	59680	1
36 KA	DPX <sup>3</sup> 250	40	4205 22	43910	1	4205 32	49468	1
		100	4205 25	43910	1	4205 35	49468	1
		160	4205 27	48484	1	4205 37	51426	1
		250	4205 29	49792	1	4205 39	52738	1
	DPX <sup>3</sup> 630	320	4221 37	60678	1	4221 42	65780	1
		400	4221 38	60678	1	4221 43	65780	1
		500	4221 39	62996	1	4221 44	75806	1
		630	4221 40	62996	1	4221 45	75806	1
DPX <sup>3</sup> 1600	800	4223 96	130198	1	4224 02	156952	1	
	1000	4223 97	173006	1	4224 03	227642	1	
	1250	4223 98	194408	1	4224 04	271106	1	
	1600	4223 99	202138	1	4224 05	305752	1	
50 KA	DPX <sup>3</sup> 250	40	4205 42	45228	1	4205 52	49986	1
		100	4205 45	45228	1	4205 55	49986	1
		160	4205 47	49770	1	4205 57	54444	1
		250	4205 49	51068	1	4205 59	63786	1
	DPX <sup>3</sup> 630	320	4221 47	59174	1	4221 52	70430	1
		400	4221 48	59418	1	4221 53	70430	1
		500	4221 49	67416	1	4221 54	85020	1
		630	4221 50	67416	1	4221 55	85020	1
	DPX <sup>3</sup> 1600	800	4224 08	139410	1	4224 14	155596	1
		1000	4224 09	187214	1	4224 15	237298	1
		1250	4224 10	206846	1	4224 16	267366	1
		1600	4224 11	220696	1	4224 17	314166	1

\* MRP - Maximum Retail Price Inclusive of all taxes including GST.  
 ■ Price available on request.

Bold Cat.Nos are products normally available with Legrand (India) Stockists. Cat.Nos that are not bold - delivery within 4 - 8 weeks from the date of order. Bold packing quantity is our mandatory packing. Orders to be placed by Legrand (India) Stockist in multiples of the same.

## DPX<sup>3</sup> MCCB

### DPX<sup>3</sup> MCCB with Electronic Sg (LSIg) Protection Unit

Category	Type	Rated Current (A)	3P			4P		
			Cat.Nos	MRP*/₹/Unit	Pack	Cat.Nos	MRP*/₹/Unit	Pack
70 kA	DPX <sup>3</sup> 250	40	4206 92	47532	1	4207 02	53874	1
		100	4206 95	47532	1	4207 05	53874	1
		160	4206 97	55568	1	4207 07	62130	1
		250	4206 99	56910	1	4207 09	65386	1
	DPX <sup>3</sup> 630	320	4221 57	72034	1	4221 62	88878	1
		400	4221 58	72034	1	4221 63	88878	1
		500	4221 59	82940	1	4221 64	112866	1
		630	4221 60	82940	1	4221 65	112866	1
	DPX <sup>3</sup> 1600	800	4224 20	141874	1	4224 26	171100	1
		1000	4224 21	198308	1	4224 27	306792	1
		1250	4224 22	276266	1	4224 28	355160	1
		1600	4224 23	373044	1	4224 29	418686	1

## DPX<sup>3</sup> MCCB

### DPX<sup>3</sup> MCCB with Electronic S2\* (LSI)\* & Energy Metering Protection Unit

- Range: 40A – 1600A, Ics=100%Icu, Three Optimum Frames
- Protection against overloads:
  - Ir adjustable from 0.4 to 1 x In
  - tr adjustable from 3 to 30s#
- Protection against short circuits:
  - Isd adjustable from 1.5 to 10 x Ir
  - tsd adjustable from 0 to 0.5s
- Inbuilt Instantaneous Protection:
  - li# – Fixed
- Option for In built or add on module for Earth Leakage Protection##
  - Adjustable sensitivity: 0.03 - 0.3 - 1 - 3 A
  - Adjustable tripping: 0 - 0.3 - 1 - 3s
- Breaking Capacity# – 25kA, 36kA, 50kA, 70kA & 100kA
- Integrated energy metering with accuracy class 2
- Measure for currents, voltage, frequency, power, energy and harmonics
- Internal Battery with battery measure function
- Communication Ready via COMM Port
- Logical Selectivity Ready (Zone Selective Interlocking)
- Dynamic Selectivity as per Selectivity Charts
- In Built USB Port for Software Diagnosis
- Suitable for Isolation

Category	Type	Rated Current (A)	3P			4P		
			Cat.Nos	MRP*/₹/Unit	Pack	Cat.Nos	MRP*/₹/Unit	Pack

### Electronic S2 + Energy metering

25 KA	DPX <sup>3</sup> 250	40	4204 02	44742	1	4204 12	51218	1
		100	4204 05	44742	1	4204 15	51234	1
		160	4204 07	48514	1	4204 17	55536	1
		250	4204 09	52530	1	4204 19	59896	1
36 KA	DPX <sup>3</sup> 250	40	4204 32	47848	1	4204 42	51974	1
		100	4204 35	47848	1	4204 45	51974	1
		160	4204 37	52172	1	4204 47	58326	1
		250	4204 39	56374	1	4204 49	65624	1
	DPX <sup>3</sup> 630	320	4220 97	63030	1	4221 02	74730	1
		400	4220 98	63030	1	4221 03	74730	1
		500	4220 99	68382	1	4221 04	84054	1
		630	4221 00	68382	1	4221 05	84054	1

■ Price available on request.

\* MRP - Maximum Retail Price Inclusive of all taxes including GST.

Bold Cat.Nos are products normally available with Legrand (India) Stockists. Cat.Nos that are not bold - delivery within 4 - 8 weeks from the date of order. Bold packing quantity is our mandatory packing. Orders to be placed by Legrand (India) Stockist in multiples of the same.

**DPX<sup>3</sup> MCCB**  
**DPX<sup>3</sup> MCCB with Electronic S2# (LSI)# & Energy Metering Protection Unit**

Category	Type	Rated Current (A)	3P			4P		
			Cat.Nos	MRP*/₹/Unit	Pack	Cat.Nos	MRP*/₹/Unit	Pack

**Electronic S2 + Energy metering**

36 KA	DPX <sup>3</sup> 1600	800	4223 48	109996	1	4223 54	123464	1
		1000	4223 49	154404	1	4223 55	216458	1
		1250	4223 50	181176	1	4223 56	245316	1
		1600	4223 51	198658	1	4223 57	270968	1
50 KA	DPX <sup>3</sup> 250	40	4204 62	53902	1	4204 72	58356	1
		100	4204 65	53902	1	4204 75	58356	1
		160	4204 67	59206	1	4204 77	64154	1
		250	4204 69	62600	1	4204 79	72282	1
	DPX <sup>3</sup> 630	320	4221 07	66848	1	4221 12	79544	1
		400	4221 08	66848	1	4221 13	79544	1
		500	4221 09	81148	1	4221 14	90688	1
		630	4221 10	81148	1	4221 15	90688	1
DPX <sup>3</sup> 1600	800	4223 60	116080	1	4223 66	143178	1	
	1000	4223 61	145910	1	4223 67	206834	1	
	1250	4223 62	174766	1	4223 68	258566	1	
	1600	4223 63	216458	1	4223 69	297426	1	
70 KA	DPX <sup>3</sup> 250	40	4206 65	56616	1	4206 75	62656	1
		100	4206 67	56616	1	4206 77	62656	1
		160	4206 68	67664	1	4206 78	71870	1
		250	4206 69	67780	1	4206 79	98576	1
	DPX <sup>3</sup> 630	320	4221 17	80270	1	4221 22	94298	1
		400	4221 18	80270	1	4221 23	93350	1
		500	4221 19	85272	1	4221 24	103850	1
		630	4221 20	85272	1	4221 25	102802	1
DPX <sup>3</sup> 1600	800	4223 72	133080	1	4223 78	165142	1	
	1000	4223 73	179418	1	4223 79	248526	1	
	1250	4223 74	213250	1	4223 80	287004	1	
	1600	4223 75	280590	1	4223 81	354344	1	

**Electronic S2 + Energy Metering + Electronic earth leakage module**

25 KA	DPX <sup>3</sup> 250	40	-	-	-	4204 22	97812	1
		100	-	-	-	4204 25	96864	1
		160	-	-	-	4204 27	102988	1
		250	-	-	-	4204 29	115998	1
36 KA	DPX <sup>3</sup> 250	40	-	-	-	4204 52	99070	1
		100	-	-	-	4204 55	96368	1
		160	-	-	-	4204 57	103826	1
		250	-	-	-	4204 59	114736	1
50 KA	DPX <sup>3</sup> 250	40	-	-	-	4204 82	102950	1
		100	-	-	-	4204 85	105892	1
		160	-	-	-	4204 87	112696	1
		250	-	-	-	4204 89	126746	1
70 KA	DPX <sup>3</sup> 250	40	-	-	-	4206 85	96164	1
		100	-	-	-	4206 87	96164	1
		160	-	-	-	4206 88	105650	1
		250	-	-	-	4206 89	134568	1

\* MRP - Maximum Retail Price Inclusive of all taxes including GST.  
 ■ Price available on request.

Bold Cat.Nos are products normally available with Legrand (India) Stockists. Cat.Nos that are not bold - delivery within 4 - 8 weeks from the date of order. Bold packing quantity is our mandatory packing. Orders to be placed by Legrand (India) Stockist in multiples of the same.

## DPX<sup>3</sup> MCCB

### DPX<sup>3</sup> MCCB with Electronic Sg (LSIg) & Energy Metering Protection Unit

- Range: 250A – 1600A, Ics=100%Icu, Two Optimum Frames
- Protection against Overloads:
  - Ir adjustable from 0.4 to 1 x In
  - tr adjustable from 3 to 30s
- Protection against Short Circuits:
  - Isd adjustable from 1.5 to 10 x Ir
  - tsd adjustable from 0 to 0.5s
- Inbuilt Instantaneous Protection:
  - li – Fixed
- Protection against Ground Fault:
  - Ig adjustable from 0.2 to 1 In & OFF
  - tg adjustable from 0.1 to 1s
- Breaking Capacity – 36kA, 50kA, 70kA & 100kA
- Integrated energy metering with accuracy class 2
- Measure for currents, voltage, frequency, power, energy and harmonics
- Internal Battery with battery measure function
- Communication Ready via COMM Port
- Logical Selectivity Ready (Zone Selective Interlocking)
- Dynamic Selectivity as per Selectivity Charts
- In Built USB Port for Software Diagnosis
- Switchable Thermal Memory
- Suitable for Isolation

Category	Type	Rated Current (A)	3P			4P		
			Cat.Nos	MRP*/₹/Unit	Pack	Cat.Nos	MRP*/₹/Unit	Pack

#### Electronic Sg + Energy metering

36 KA	DPX <sup>3</sup> 630	320	4221 77	76088	1	4221 82	86524	1
		400	4221 78	76088	1	4221 83	86524	1
		500	4221 79	80746	1	4221 84	97994	1
		630	4221 80	80746	1	4221 85	97994	1
	DPX <sup>3</sup> 1600	800	4224 44	150012	1	4224 50	174766	1
		1000	4224 45	191602	1	4224 51	251732	1
		1250	4224 46	207796	1	4224 52	280590	1
		1600	4224 47	220142	1	4224 53	325484	1
50 KA	DPX <sup>3</sup> 630	320	4221 87	79914	1	4221 92	92252	1
		400	4221 88	79914	1	4221 93	92252	1
		500	4221 89	87952	1	4221 94	107356	1
		630	4221 90	87952	1	4221 95	107356	1
	DPX <sup>3</sup> 1600	800	4224 56	135542	1	4224 62	163544	1
		1000	4224 57	161876	1	4224 63	243714	1
		1250	4224 58	230886	1	4224 64	298228	1
		1600	4224 59	272574	1	4224 65	347132	1
70 KA	DPX <sup>3</sup> 630	320	4221 97	90532	1	4222 02	106782	1
		400	4221 98	90532	1	4222 03	106782	1
		500	4221 99	101110	1	4222 04	130058	1
		630	4222 00	101110	1	4222 05	130058	1
	DPX <sup>3</sup> 1600	800	4224 68	143970	1	4224 74	186794	1
		1000	4224 69	227680	1	4224 75	302108	1
		1250	4224 70	261830	1	4224 76	346696	1
		1600	4224 71	346808	1	4224 77	405264	1

#### Switch disconnecter

	DPX <sup>3</sup> 160	160	4201 98	9488	1	4201 99	11910	1
		250	4202 99	18604	1	4203 00	25584	1
	DPX <sup>3</sup> 630	400	4222 16	26698	1	4222 18	36884	1
		630	4222 17	33364	1	4222 19	42802	1

■ Price available on request.

\* MRP - Maximum Retail Price Inclusive of all taxes including GST.

Bold Cat.Nos are products normally available with Legrand (India) Stockists. Cat.Nos that are not bold - delivery within 4 - 8 weeks from the date of order. Bold packing quantity is our mandatory packing. Orders to be placed by Legrand (India) Stockist in multiples of the same.

## DPX<sup>3</sup> MCCB

Category	Type	Rated Current (A)	3P			4P		
			Cat.Nos	MRP*/₹/Unit	Pack	Cat.Nos	MRP*/₹/Unit	Pack

### Only magnetic

16 KA	DPX <sup>3</sup> 160	16	4207 10	13736	1	-	-	-
		25	4207 11	13736	1	-	-	-
		50	4207 12	13736	1	-	-	-
		63	4207 13	13736	1	-	-	-
25 KA	DPX <sup>3</sup> 160	16	4207 14	15618	1	-	-	-
		25	4207 15	15618	1	-	-	-
		50	4207 16	15618	1	-	-	-
		63	4207 17	15618	1	-	-	-
36 KA	DPX <sup>3</sup> 250	100	4207 18	27276	1	-	-	-
		160	4207 19	27276	1	-	-	-
		200	4207 20	28840	1	-	-	-
		250	4207 21	30398	1	-	-	-
70 KA	DPX <sup>3</sup> 250	100	4207 22	26658	1	-	-	-
		160	4207 23	26658	1	-	-	-
		200	4207 24	28328	1	-	-	-
		250	4207 25	29990	1	-	-	-

### Accessories

Type	Rotary handle				Shunt release											
	Direct		Vary depth		12 V		24 V		48 V		110 V		230 V		400 V	
	Cat.No	MRP	Cat.No	MRP	Cat.No	MRP	Cat.No	MRP	Cat.No	MRP	Cat.No	MRP	Cat.No	MRP	Cat.No	MRP
DPX <sup>3</sup> 160 DPX <sup>3</sup> 250	4201 60	1360	4201 61	2024	4210 12	2646	4210 13	2646	4210 14	2646	4210 15	2646	4210 16	2646	4210 17	2646
DPX <sup>3</sup> 630	4201 62	2178	4201 63	3844												
DPX <sup>3</sup> 1600	0262 61	4534	0262 83	6952	-		4222 39	2796	4222 40	2796	4222 41	2796	4222 42	2796	4222 43	2796

Type	U/V release													
	12 V		24 V		48 V		110 V		230 V		400 V		480 V	
	Cat.No	MRP	Cat.No	MRP	Cat.No	MRP	Cat.No	MRP	Cat.No	MRP	Cat.No	MRP	Cat.No	MRP
DPX <sup>3</sup> 160 DPX <sup>3</sup> 250	4210 18	3308	4210 19	3308	4210 20	3308	4210 21	3276	4210 22	3276	4210 24	3276	4210 25	3276
DPX <sup>3</sup> 630 DPX <sup>3</sup> 1600	-		4222 45	3690	4222 46	3690	4222 47	3926	4222 48	3926	4222 49	3926	-	

Type	Rated Current (A)	Spreaders**				Motor Operator									
		3P (Set of 3)		4P (Set of 4)		24-230V Side		24V		48V		110V		230V	
		Cat.No	MRP	Cat.No	MRP	Cat.No	MRP	Cat.No	MRP	Cat.No	MRP	Cat.No	MRP	Cat.No	MRP
DPX <sup>3</sup> 160		6250 02	750	6250 06	1000										
DPX <sup>3</sup> 250		6250 14	750	6250 18	1000	4210 60	37342	4210 61	33546	4210 61	33546	4210 61	33546	4210 61	33546
DPX <sup>3</sup> 630	Upto 400 A	4226 31	1500	4226 32	2000										
	630 A	6250 04	1750	6250 08	2250	-		0261 40	67850	0261 41	67850	-		0261 44	54358
DPX <sup>3</sup> 1600	Upto 1250 A	4226 24	10754	4226 25	13060	-		0261 24	129300	0261 25	111550	0261 26	62942	0261 23	62942
	1600 A	0262 73	28014	0262 74	32400	-		0261 19	129300	0261 28	111550	0261 29	62942	0261 27	63542

\* MRP - Maximum Retail Price Inclusive of all taxes including GST.  
 ■ Price available on request.

Bold Cat.Nos are products normally available with Legrand (India) Stockists.  
 Cat.Nos that are not bold - delivery within 4 - 8 weeks from the date of order.  
 Bold packing quantity is our mandatory packing. Orders to be placed by Legrand (India) Stockist in multiples of the same.



## DPX<sup>3</sup> 160 equipment and mounting accessories



4210 40

Cat.Nos	Description	MRP* ₹ / Unit	Pack
---------	-------------	------------------	------

### Equipment for plug-in version

4210 40	For DPX <sup>3</sup> 160 - 3P	22404	1
4210 41	For DPX <sup>3</sup> 160 - 4P	30030	1
4210 44	Set of connectors for auxiliary contacts	3210	1
4210 45	Key barrel and flat key for Padlocks	20444	1
4210 46	Key barrel and star key for Padlocks	18516	1
4210 47	Padlock accessory	5682	1

### Connection accessories

4210 26	Set of 3 terminals for High capacity cage terminals	8522	1
4210 27	Set of 4 terminals for High capacity cage terminals	11266	1
4210 70	Set of 3 insulated shields	190	1
4210 28	Set of 3 terminals Screw terminals for copper bars connection	968	1
4210 29	Set of 4 terminals Screw terminals for copper bars connection	1032	1
6250 02	Set of 3 spreaders for DPX <sup>3</sup> 160 3P	750	1
6250 06	Set of 4 spreaders for DPX <sup>3</sup> 160 4P	1000	1

### Connection accessories

4210 36	Set of 3 rear terminals for DPX <sup>3</sup> 160 3P	4558	1
4210 37	Set of 4 rear terminals for DPX <sup>3</sup> 160 4P	6114	1

### Sealable terminal shields

#### For front terminals

4210 54	For DPX <sup>3</sup> 160 3P	4976	1
4210 55	For DPX <sup>3</sup> 160 3P	5256	1

#### For rear terminals

4210 50	For DPX <sup>3</sup> 160 3P	3146	1
4210 51	For DPX <sup>3</sup> 160 4P	2798	1

### Fixing plates

4210 71	For DPX <sup>3</sup> 160 3P / 4P without earth leakage module	460	1
4210 73	For DPX <sup>3</sup> 160 4P with earth leakage module	1130	1
4210 68	For DPX <sup>3</sup> 160 3P / 4P with side mounting motor operator	1158	1

■ Price available on request.

\* MRP - Maximum Retail Price Inclusive of all taxes including GST.

MCCB Prices are without spreaders. For ordering spreaders refer page no. 21

## DPX<sup>3</sup> 160 and 250 common auxiliaries and accessories



4210 58

Cat.Nos	Description	MRP* ₹ / Unit	Pack
---------	-------------	------------------	------

### Supply inverter type

4210 58	For fixed version	4202	1
4210 59	For plug-in and draw-out version	4478	1

### Rotary handles

<b>4201 60</b>	Standard handle for thermal magnetic DPX <sup>3</sup>	1360	1
<b>4201 61</b>	Vari-depth standard handles	2024	1
4201 67	Key Lock for VD RH DPX <sup>3</sup> 160 & 250	2388	1
4201 65	Key Lock for DIR RH Type A DPX <sup>3</sup> 160 & 250	2320	1
4201 68	Key Lock for VD RH Type A DPX <sup>3</sup> 160 & 250	2388	1
4201 66	Key Lock for DIR RH Type B DPX <sup>3</sup> 160 & 250	2320	1
4201 69	Key Lock for VD RH Type B DPX <sup>3</sup> 160 & 250	2388	1

### Motor-driven handles

4210 60	Side motor operator	37342	1
4210 61	Front motor operator	33546	1
4210 62	Ronis key barrel for front motor operator	7664	1
4210 63	Profalux key barrel for front motor operator	18208	1

## DPX<sup>3</sup> 160 and 250 common auxiliaries and accessories

4210 64	Padlock for front motor operator	2598	1
4210 65	Ronis key barrel for side motor operator	20216	1
4210 66	Profalux key barrel for side motor operator	18368	1
4210 67	Padlock for side motor operator	2758	1

### Auxiliary contacts

<b>4210 10</b>	1 N/C + 1 N/O auxiliary contact for rotary handles	1522	1
<b>4210 11</b>	Auxiliary contact or fault signalling contact	1188	1
4210 48	Signalling contact plugged-in/drawn-out (for DPX <sup>3</sup> plug-in version)	1280	1

### Locking accessory

4210 49	Padlock for locking in "open" position	1306	1
---------	--	------	---

### Communication interface

4210 75	Modbus	17254	1
---------	--------	-------	---

Bold Cat.Nos are products normally available with Legrand (India) Stockists. Cat.Nos that are not bold - delivery within 4 - 8 weeks from the date of order. Bold packing quantity is our mandatory packing. Orders to be placed by Legrand (India) Stockist in multiples of the same.

## DPX<sup>3</sup> 250 equipment and mounting accessories

Cat.Nos	Description	MRP* ₹ / Unit	Pack
---------	-------------	------------------	------

### Equipment for plug-in version

4210 42	For DPX <sup>3</sup> 250 - 3P	25088	1
4210 43	For DPX <sup>3</sup> 250 - 4P with or without earth leakage module	30220	1
4210 44	Set of connectors for auxiliary contacts	3210	1
4210 45	Key barrel and flat key N° ABA90GEL6149 for Padlocks	20444	1
4210 46	Key barrel and star key N° HBA90GPS6149 for Padlocks	18516	1
4210 47	Padlock accessory	5682	1

### Connection accessories

4210 30	Set of 3 cage terminals	3436	1
4210 31	Set of 4 cage terminals	4474	1
4210 70	Set of 3 phase barriers	190	1

### Connection accessories

6250 14	Set of 3 spreaders for DPX <sup>3</sup> 250 3P	750	1
6250 18	Set of 4 spreaders for DPX <sup>3</sup> 250 4P	1000	1
4210 38	Set of 3 rear terminals for DPX <sup>3</sup> 250 3P	4604	1
4210 39	Set of 4 rear terminals for DPX <sup>3</sup> 250 4P	6200	1

### Sealable terminal shields

#### For front terminals

4210 56	For DPX <sup>3</sup> 250 3P	5154	1
4210 57	For DPX <sup>3</sup> 250 4P	5458	1

#### For rear terminals

4210 52	For DPX <sup>3</sup> 250 3P	3076	1
4210 53	For DPX <sup>3</sup> 250 4P	3384	1

### Fixing plates

4210 72	For DPX <sup>3</sup> 250 3P / 4P without earth leakage module	460	1
4210 74	For DPX <sup>3</sup> 250 4P with earth leakage module	1954	1
4210 69	For DPX <sup>3</sup> 250 3P / 4P with side mounting motor operator	1140	1

## DPX<sup>3</sup> 630 equipment and accessories

### Plug-in version

4222 20	Set of incoming and outgoing terminals - 3P (6 terminals for 3P DPX <sup>3</sup> or 8 terminals for 4P DPX <sup>3</sup> )	4068	1
---------	---	------	---

## DPX<sup>3</sup> 630 equipment and accessories

Cat.Nos	Description	MRP* ₹ / Unit	Pack
---------	-------------	------------------	------

### Plug-in version

4222 21	Set of incoming and outgoing terminals - 4P (6 terminals for 3P DPX <sup>3</sup> or 8 terminals for 4P DPX <sup>3</sup> )	5086	1
4222 22	Front terminal mounting base for DPX <sup>3</sup> only - 3P	10164	1
4222 24	Flat rear terminal mounting base for DPX <sup>3</sup> only - 3P	15830	1
4222 23	Front terminal mounting base for DPX <sup>3</sup> only - 4P	12718	1
4222 25	Flat rear terminal mounting base for DPX <sup>3</sup> only - 4P	■	1
4222 26	Front terminal mounting base for DPX <sup>3</sup> with earth leakage module - 4 P	■	1
4222 27	Flat rear terminal mounting base for DPX <sup>3</sup> with earth leakage module - 4P	■	1
4222 37	For fixing the signalling contact - 4P Cat.No 0265 74 on a DPX <sup>3</sup> plug-in version	3388	1
4222 28	Set of 2 extractor handle	4748	1
4222 29	Set of connectors (24-pin)	2668	1

### Draw-out version

4222 31	"Debro-lift" mechanism for DPX <sup>3</sup> base only - 3P	31200	1
4222 32	"Debro-lift" mechanism for DPX <sup>3</sup> base only - 4P	■	1
4222 33	"Debro-lift" mechanism for DPX <sup>3</sup> base with elm - 4P	■	1
0265 76	One key for "Debro-lift" mechanism for DPX <sup>3</sup> only - Flat key	■	1
0265 78	Two keys (one key supplied) for "Debro-lift" mechanism for motorised DPX <sup>3</sup> or with rotary handle - Flat key	■	1
0263 48	One key for "Debro-lift" mechanism for DPX <sup>3</sup> only - Star key	■	1
0265 77	Two keys (one key supplied) for motorised DPX <sup>3</sup> or with rotary handle - Star key	■	1
0265 75	Handle for drawing-out for "Debro-lift" mechanism	5014	1
0265 74	Signalling contact (plugged-in/drawn-out) for "Debro-lift" mechanism	3176	1
4222 36	For fixing the signalling contact Cat.No 0265 74 on a DPX <sup>3</sup> draw-out version	3414	1

■ Price available on request.

\* MRP - Maximum Retail Price Inclusive of all taxes including GST.

MCCB Prices are without spreaders. For ordering spreaders refer page no. 21

Bold Cat.Nos are products normally available with Legrand (India) Stockists. Cat.Nos that are not bold - delivery within 4 - 8 weeks from the date of order. Bold packing quantity is our mandatory packing. Orders to be placed by Legrand (India) Stockist in multiples of the same.

## DPX<sup>3</sup> 630 equipment and accessories

Cat.Nos	Description	MRP* ₹ / Unit	Pack
---------	-------------	------------------	------

### Draw-out version

4222 30	Block of 6 automatic auxiliary contacts for DPX <sup>3</sup> draw-out version (up to 2 blocks by DPX <sup>3</sup> )	6600	1
---------	---	------	---

### Supply inverter type

0264 09	Plate for MCCB or trip-free switch fixed version	10910	1
0264 04	Plate for MCCB or trip-free switch plug-in and draw-out version	15158	1

### Rotary handles

4201 62	Direct rotary handle	2178	1
4201 63	Vari-depth rotary handle	3844	1
4201 70	Key Lock for VD RH DPX <sup>3</sup> 630	2600	1
4201 71	Key Lock for VD RH Type A DPX <sup>3</sup> 630	2600	1
4201 72	Key Lock for VD RH Type B DPX <sup>3</sup> 630	2600	1

### Motor-driven handles

0261 40	Front operated 24 V~/=	67850	1
0261 41	Front operated 48 V~/=	67850	1
0261 44	Front operated 230 V~	54358	1
0261 59	Lock and flat key	8604	1
0261 58	Lock and star key	16010	1

### Accessories

0262 30	Set of 3 Insulated shields	224	1
0262 44	Set of 2 sealable terminal shields - 3P	6272	1
0262 45	Set of 2 sealable terminal shields - 4P	1894	1
0262 40	Padlock for locking in "OPEN" position - 4P	2290	1
0262 46	Set of 4 adaptors + insulated shields for lug - 4P	8700	1
0262 47	Set of 4 extended front terminals - 4P	6704	1
6250 04	Set of incoming or outgoing spreaders - 3P	1750	1
6250 08	Set of incoming or outgoing spreaders - 4P	2250	1
0263 50	Set of incoming or outgoing swivel rear terminals - 3P	■	1
0263 52	Set of incoming or outgoing flat rear terminals - 3P	21654	1
0263 51	Set of incoming or outgoing swivel terminals - 4P	■	1
0263 53	Set of incoming or outgoing flat terminals - 4P	18382	1
4222 34	Set of 2 IP 20 terminal covers - 3P	1446	1
4222 35	Set of 2 IP 20 terminal covers - 4P	5166	1



0261 40



6250 04



4222 34



4222 35

■ Price available on request.

\* MRP - Maximum Retail Price Inclusive of all taxes including GST.

## DPX<sup>3</sup> 630 earth leakage module

Type and frame size	Rated Current (A)	Poles	Cat.Nos	MRP* ₹ / Unit	Pack
---------------------	-------------------	-------	---------	------------------	------

### Earth Leakage Module

#### Standard

DPX <sup>3</sup> 630	400 A	3 Pole	0260 60	39476	1
	630 A	3 Pole	0260 64	73516	1
DPX <sup>3</sup> 630	400 A	4 Pole	0260 61	69292	1
	630 A	4 Pole	0260 65	73036	1

#### LED Version

DPX <sup>3</sup> 630	400 A	4 Pole	0260 63	■	1
	630 A	4 Pole	0260 67	73706	1

## DPX<sup>3</sup> 1600 equipment and accessories

Cat.Nos	Description	MRP* ₹ / Unit	Pack
---------	-------------	------------------	------

### Draw-out version

4225 86	Front terminals - 3P	■	1
4225 88	Rear terminals - 3P	■	1
4225 87	Front terminals - 4P	■	1
4225 89	Rear terminals - 4P	■	1
4225 93	Debtor-lift mechanism For DPX <sup>3</sup> 1600 - 3P	■	1
4225 94	Debtor-lift mechanism for DPX <sup>3</sup> 1600 - 4P	■	1
4225 95	For fixing the signalling contact Cat.No 0265 74 on a DPX <sup>3</sup> draw-out version	■	1
0265 76	One key for "Debtor-lift" mechanism for DPX <sup>3</sup> only - Flat key	■	1
0265 80	Two key (one key supplied) for motorised DPX <sup>3</sup> or with rotary handle	■	1
0263 48	One key for DPX <sup>3</sup> only - Starkey	■	1
0265 79	Two key (one key supplied) for motorised DPX <sup>3</sup> or with rotary handle	■	1
0265 75	Handle for drawing-out for "Debtor-lift" mechanism	5014	1
0265 74	Signalling contact (plugged-in/drawn-out)	3176	1
4222 30	Block of 6 automatic auxiliary contacts for DPX <sup>3</sup> draw-out version (up to 2 blocks by DPX <sup>3</sup> )	6600	1



4225 88  
+  
4225 93

Bold Cat.Nos are products normally available with Legrand (India) Stockists. Cat.Nos that are not bold - delivery within 4 - 8 weeks from the date of order. Bold packing quantity is our mandatory packing. Orders to be placed by Legrand (India) Stockist in multiples of the same.

## DPX<sup>3</sup> 1600 equipment and accessories

Cat.Nos	Description	MRP* ₹ / Unit	Pack
---------	-------------	------------------	------

### Supply inverter type

0264 10	Plate for MCCBs or trip-free switch fixed version	13134	1
0264 05	Plate for MCCBs or trip-free switch plug-in and draw-out version	28550	1

### Rotary handles

0262 61	Standard (black) direct on DPX <sup>3</sup>	4534	1
0262 83	Standard (black) vari-depth handle IP 55	6952	1
0262 93	Key barrel and flat key	2582	1
0262 94	Key barrel and star key	14246	1

### Motor-driven handles

0261 54	Front operated 230 V±	81140	1
0261 24	Front operated 24 V±/= for I <sub>n</sub> ≤ 1250 A	129300	1
0261 25	Front operated 48 V±/= for I <sub>n</sub> ≤ 1250 A	101400	1

### Motor-driven handles

0261 26	Front operated 110 V±/= for I <sub>n</sub> ≤ 1250 A	62942	1
0261 23	Front operated 230 V±/= for I <sub>n</sub> ≤ 1250 A	62942	1
0261 19	Front operated 24 V±/= for I <sub>n</sub> = 1600 A	129300	1
0261 28	Front operated 48 V±/= for I <sub>n</sub> = 1600 A	101400	1
0261 29	Front operated 110 V±/= for I <sub>n</sub> = 1600 A	■	1
0261 27	Front operated 230 V±/= for I <sub>n</sub> = 1600 A	63542	1
0261 59	Key and flat key	8604	1
0261 58	Key and star key	16010	1

### Accessories

0262 66	Set of 3 insulated shields	440	1
0262 64	Set of 2 sealable terminal shields - 3P	13050	1
0262 65	Set of 2 sealable terminal shields - 4P	2662	1
0262 60	Padlock for locking in "open" position	2252	1
0262 67	Set of 4 extended front short terminals for 630 - 1250 A (2 bars max. per pole)	15850	1



0262 60

- Price available on request.
- \* MRP - Maximum Retail Price Inclusive of all taxes including GST.
- ❖ For Cat.Nos. and further details please contact th nearest branch.
- ▼ For communication add 4226 82 + 4226 89

## DPX<sup>3</sup> 630 and 1600 common auxiliaries

Cat.Nos	Description	MRP* ₹ / Unit	Pack
---------	-------------	------------------	------

### Accessories

0262 68	Set of 4 extended front Long terminals for 1600 A (3 bars max. per pole)	22318	1
4226 24	Set of incoming or outgoing spreaders for 800 A & 1000 A - 3P	10754	1
4226 25	Set of incoming or outgoing spreaders for 800 A & 1000 A - 4P	13060	1
0262 73	Set of incoming or outgoing spreaders for 1250 A & 1600 A - 3P	28014	1
0262 74	Set of incoming or outgoing spreaders for 1250 A & 1600 A - 4P	32400	1
0263 80	Short rear terminals - 3P	■	1
0263 81	Long rear terminals - 3P	■	1
0263 82	Short rear terminals - 4P	■	1
0263 83	Long rear terminals - 4P	■	1
4225 90	Set of 2 IP 20 terminal covers - 3P	1650	1
4225 91	Set of 2 IP 20 terminal covers - 4P	2682	1
4225 92	External neutral - 4P	17026	1



0262 67  
+  
0262 68

### Common auxiliaries

4210 11	For signalling the state of the contacts or opening of the MCCB on a fault For DPX <sup>3</sup> /DPX <sup>3</sup> -I Changeover switch 3 A - 240 V±	1188	1
---------	--	------	---

### Releases

Allow remote tripping of a DPX<sup>3</sup>

#### Time-lag undervoltage releases (800 ms)

Prevent false tripping in the event of power supply microbreaks.

Require a time-lag module connected to the undervoltage release Cat.No 4226 23

0261 90	Time-lag module 230 VA 3 module	23500	1
---------	------------------------------------	-------	---

Bold Cat.Nos are products normally available with Legrand (India) Stockists. Cat.Nos that are not bold - delivery within 4 - 8 weeks from the date of order. Bold packing quantity is our mandatory packing. Orders to be placed by Legrand (India) Stockist in multiples of the same.

# DPX<sup>3</sup> MCCB

Rotary handles  
for DPX<sup>3</sup>



- Smaller dimension of rotary handle base for better visibility of parameters and better access to trip unit
- Easy installation
- Spring for better play
- Door defeat mechanism for easy maintenance
- ON / OFF indication on the knob
- Pad Locking on the knob – upto 3 Locks



Scan to know more about  
the product.

Cat.Nos	Description	MRP* ₹ / Unit	Pack
---------	-------------	------------------	------

### Releases

0261 91	Time-lag module 400 VA	34300	1
4226 23	Undervoltage release for DPX <sup>3</sup> 630 and 1600	■	1

### Auto Transfer Controller

4226 81	Standard unit	35100	1
4226 82	Advanced unit	41748	1
4226 89▼	Communication module	11192	1

### Residual current relay

0260 88	Residual current relay to clip on module 2 rail	24854	1
---------	--	-------	---

### Current Transformer

0260 92	Coil Ø35 mm	13978	1
0260 93	Coil Ø80 mm	19802	1
0260 94	Coil Ø110 mm	31452	1
0260 95	Coil Ø140 mm	33092	1
0260 96	Coil Ø210 mm	56446	1
0260 97	Coil Ø150 mm - open	■	1
0260 98	Coil Ø300 mm - open	■	1

### Metal one way enclosures for MCCB

Cat.Nos	Description	No. of modules	MRP* ₹ / Unit	Pack
5078 01	DPX3 160 MCCB enclosure	3&4	4982	1
5078 02	DPX3 250 MCCB enclosure	3&4	8846	1
5078 04	DPX3 630 MCCB enclosure	3&4	13410	1



4226 82



0260 88



0260 93  
coil for use  
with relay



0260 98

■ Price available on request.

\* MRP - Maximum Retail Price Inclusive of all taxes including GST.

❖ For Cat.Nos. and further details please contact th nearest branch.

▼ For communication add 4226 82 + 4226 89

Bold Cat.Nos are products normally available with Legrand (India) Stockists.  
Cat.Nos that are not bold - delivery within 4 - 8 weeks from the date of order.  
Bold packing quantity is our mandatory packing. Orders to be placed by  
Legrand (India) Stockist in multiples of the same.



# DRX

MCCB RANGE

## MCCB RANGE



## DRX MCCB WORLD CLASS SOLUTION WITH A RANGE OF ACCESSORIES AND WINNING FEATURES

NEW DRX MCCBs RANGE.  
MULTIPLE FEATURES.



Accurate performance at higher temperature "No Deration upto 50° Cel"



Overload & Overload Pre-Alarm Indication



Integrated Contact module for Status Indication



Complete Range with Adjustable Protection



In built Neutral Protection in 4<sup>th</sup> Pole



Switchable Thermal Memory



Over - Temperature Alarm Indication



Adjustable Time Settings

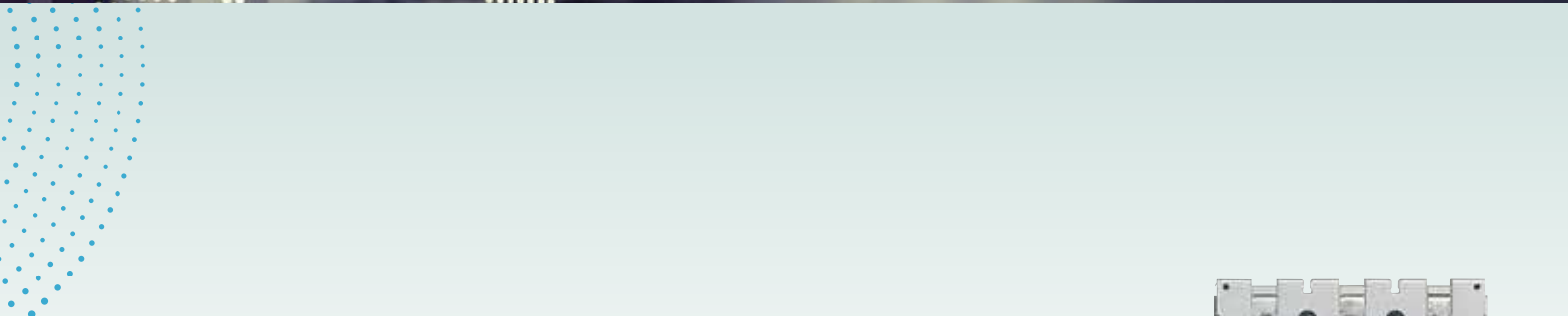

## A COMPREHENSIVE RANGE

The robust design of DRX MCCB offer adjustable protection, different accessories for connection and remote tripping. They are the ideal choice in terms of efficiency and affordability for protection of your electrical installations of up to 630A.



Scan to know more about the product.

## DRX MCCB

### DRX MCCB with Thermal Magnetic Protection Unit

**NEW!**

Range – 16A to 630A

Ics = 100% Icu

Thermal Adjustable – 0.8 to 1 In

Magnetic Setting – 10 In for DRX125HP

Magnetic Setting – Adjustable 5 to 10 In for DRX250HP and DRX630

Suitable for Isolation

Category	Type	Rated Current (A)	3P			4P		
			Cat.Nos	MRP*/₹/Unit	Pack	Cat.Nos	MRP*/₹/Unit	Pack

#### Thermal Magnetic : O/L & S/C protection

25 KA	DRX 125 <sup>HP</sup>	16	6697 00	7712	1	6697 10	10720	1
		20	6697 01	7712	1	6697 11	10720	1
		25	6697 02	7712	1	6697 12	10720	1
		32	6697 03	7712	1	6697 13	10720	1
		40	6697 04	7712	1	6697 14	10720	1
		50	6697 05	7712	1	6697 15	10720	1
		63	6697 06	7712	1	6697 16	10720	1
		80	6697 07	7712	1	6697 17	10720	1
		100	6697 08	7712	1	6697 18	10720	1
		125	6697 09	11420	1	6697 19	13542	1
36 KA	DRX 125 <sup>HP</sup>	16	6697 20	10040	1	6697 30	12528	1
		20	6697 21	10040	1	6697 31	12528	1
		25	6697 22	10040	1	6697 32	12528	1
		32	6697 23	10040	1	6697 33	12528	1
		40	6697 24	10040	1	6697 34	12528	1
		50	6697 25	10040	1	6697 35	12528	1
		63	6697 26	10040	1	6697 36	12528	1
		80	6697 27	10040	1	6697 37	12528	1
		100	6697 28	10040	1	6697 38	12528	1
		125	6697 29	11548	1	6697 39	14574	1
50 KA	DRX 125 <sup>HP</sup>	16	6697 40	12830	1	6697 50	16166	1
		20	6697 41	12830	1	6697 51	16166	1
		25	6697 42	12830	1	6697 52	16166	1
		32	6697 43	12830	1	6697 53	16166	1
		40	6697 44	12830	1	6697 54	16166	1
		50	6697 45	12830	1	6697 55	16166	1
		63	6697 46	12830	1	6697 56	16166	1
		80	6697 47	12830	1	6697 57	16166	1
		100	6697 48	12830	1	6697 58	16166	1
		125	6697 49	16814	1	6697 59	19374	1

■ Price available on request.

\* MRP - Maximum Retail Price Inclusive of all taxes including GST.

Bold Cat.Nos are products normally available with Legrand (India) Stockists. Cat.Nos that are not bold - delivery within 4 - 8 weeks from the date of order. Bold packing quantity is our mandatory packing. Orders to be placed by Legrand (India) Stockist in multiples of the same.

## DRX MCCB

### DRX MCCB with Thermal Magnetic Protection Unit

**NEW !**

Category	Type	Rated Current (A)	3P			4P			
			Cat.Nos	MRP*/₹/Unit	Pack	Cat.Nos	MRP*/₹/Unit	Pack	
<b>Thermal Magnetic : O/L &amp; S/C protection</b>									
25 KA	DRX 250 <sup>HP</sup>	16	6690 00	■	1	6690 20	■	1	
		20	6690 01	■	1	6690 21	■	1	
		25	6690 02	■	1	6690 22	■	1	
		32	6690 03	■	1	6690 23	■	1	
		40	6690 04	■	1	6690 24	■	1	
		50	6690 05	■	1	6690 25	■	1	
		63	6690 06	■	1	6690 26	■	1	
		80	6690 07	■	1	6690 27	■	1	
		100	6690 08	■	1	6690 28	■	1	
		125	6690 09	■	1	6690 29	■	1	
		160	6690 10	16340	1	6690 30	18960	1	
		200	6690 11	18610	1	6690 31	22800	1	
		250	6690 12	21630	1	6690 32	25880	1	
36 KA	DRX 250 <sup>HP</sup>	16	6690 40	■	1	6690 60	■	1	
		20	6690 41	■	1	6690 61	■	1	
		25	6690 42	■	1	6690 62	■	1	
		32	6690 43	■	1	6690 63	■	1	
		40	6690 44	■	1	6690 64	■	1	
		50	6690 45	■	1	6690 65	■	1	
		63	6690 46	■	1	6690 66	■	1	
		80	6690 47	■	1	6690 67	■	1	
		100	6690 48	■	1	6690 68	■	1	
		125	6690 49	■	1	6690 69	■	1	
		160	6690 50	16510	1	6690 70	18490	1	
		200	6690 51	20440	1	6690 71	26400	1	
		250	6690 52	23400	1	6690 72	28190	1	
		DRX 630	320	6676 50	29260	1	6676 54	35626	1
			400	6676 51	29260	1	6676 55	36298	1
			500	6676 52	37722	1	6676 56	47462	1
			630	6676 53	37722	1	6676 57	49722	1



6676 51

■ Price available on request.

\* MRP - Maximum Retail Price Inclusive of all taxes including GST.

Bold Cat.Nos are products normally available with Legrand (India) Stockists. Cat.Nos that are not bold - delivery within 4 - 8 weeks from the date of order. Bold packing quantity is our mandatory packing. Orders to be placed by Legrand (India) Stockist in multiples of the same.



## DRX MCCB

### DRX MCCB with Thermal Magnetic Protection Unit

NEW!

Category	Type	Rated Current (A)	3P			4P		
			Cat.Nos	MRP*/₹/Unit	Pack	Cat.Nos	MRP*/₹/Unit	Pack

#### Thermal Magnetic : O/L & S/C protection

50 KA	DRX 250 <sup>HP</sup>	16	6690 80	■	1	6691 00	■	1	
		20	6690 81	■	1	6691 01	■	1	
		25	6690 82	■	1	6691 02	■	1	
		32	6690 83	■	1	6691 03	■	1	
		40	6690 84	■	1	6691 04	■	1	
		50	6690 85	■	1	6691 05	■	1	
		63	6690 86	■	1	6691 06	■	1	
		80	6690 87	■	1	6691 07	■	1	
		100	6690 88	■	1	6691 08	■	1	
		125	6690 89	■	1	6691 09	■	1	
		160	6690 90	20600	1	6691 10	24000	1	
		200	6690 91	24920	1	6691 11	31010	1	
	250	6690 92	26800	1	6691 12	33000	1		
		DRX 630	320	6676 58	32212	1	6676 62	40514	1
			400	6676 59	32212	1	6676 63	40514	1
	500		6676 60	45632	1	6676 64	57006	1	
	630		6676 61	45632	1	6676 65	57006	1	



6690 92



6676 61

## DRX MCCB

### DRX MCCB with Electronic S2 (LSI) Protection Unit

- Range: 40A – 630A, Ics=100%Icu, Two Optimum Frames
- Protection against overloads:
  - Ir adjustable from 0.4 to 1 x In
  - tr adjustable from 3 to 30s#
- Protection against short circuits:
  - I<sub>sd</sub> adjustable from 1.5 to 10 x Ir
  - t<sub>sd</sub> adjustable from 0 to 0.5s
- Inbuilt Instantaneous Protection:
  - I<sub>i#</sub> – Fixed
- Overload Alarm Indication - I > 1.05 Ir
- Pre-Overload Alarm Indication - I > 0.9 Ir
- Over temperature Alarm Indication - T > 90 °C
- Integrated Contact Module (On/Off/ Trip ) for DRX 250HP Electronic MCCBs
- Suitable for Isolation

Category	Type	Rated Current (A)	3P			4P		
			Cat.Nos	MRP*/₹/Unit	Pack	Cat.Nos	MRP*/₹/Unit	Pack

#### Electronic S2

36 KA	DRX 250 <sup>HP</sup>	40	6691 70	17526	1	6691 80	22280	1	
		100	6691 71	17526	1	6691 81	22280	1	
		160	6691 72	22430	1	6691 82	31372	1	
		250	6691 73	30782	1	6691 83	42014	1	
		DRX 630	320	6699 01	39922	1	6699 06	49178	1
	400		6699 02	39922	1	6699 07	49178	1	
		630	6699 04	44840	1	6699 09	58726	1	

\* MRP - Maximum Retail Price Inclusive of all taxes including GST.  
 ■ Price available on request.

Bold Cat.Nos are products normally available with Legrand (India) Stockists. Cat.Nos that are not bold - delivery within 4 - 8 weeks from the date of order. Bold packing quantity is our mandatory packing. Orders to be placed by Legrand (India) Stockist in multiples of the same.

## DRX MCCB

### DRX MCCB with Electronic S2 (LSI) Protection Unit

#### Electronic S2

50 KA	DRX 250 <sup>HP</sup>	40	6691 90	21120	1	6692 00	29164	1
		100	6691 91	21120	1	6692 01	29164	1
		160	6691 92	27438	1	6692 02	35972	1
		250	6691 93	35022	1	6692 03	44868	1
	DRX 630	320	6699 11	43684	1	6699 16	55686	1
		400	6699 12	43684	1	6699 17	55686	1
630		6699 14	48456	1	6699 19	62050	1	

## DRX MCCB

### DRX MCCB with Electronic Sg (LSIg) Protection Unit

- Range: 40A – 630A, Ics=100%Icu, Two Optimum Frames
- Protection against overloads:
  - Ir adjustable from 0.4 to 1 x In
  - tr adjustable from 3 to 30s#
- Protection against short circuits:
  - I<sub>sd</sub> adjustable from 1.5 to 10 x Ir
  - t<sub>sd</sub> adjustable from 0 to 0.5s
- Inbuilt Instantaneous Protection:
  - I<sub>#</sub> – Fixed
- Protection against Ground Fault:
  - I<sub>g</sub> adjustable from 0.2 to 1 In & OFF
  - t<sub>g</sub> adjustable from 0.1 to 1s
- Overload Alarm Indication - I > 1.05 Ir
- Pre-Overload Alarm Indication - I > 0.9 Ir
- Over temperature Alarm Indication - T > 90 °C
- Integrated Contact Module (On/Off/ Trip ) for DRX 250HP Electronic MCCBs
- Suitable for Isolation

Category	Type	Rated Current (A)	3P			4P		
			Cat.Nos	MRP*/₹/Unit	Pack	Cat.Nos	MRP*/₹/Unit	Pack

#### Electronic Sg

36 KA	DRX 250 <sup>HP</sup>	40	6691 75	32308	1	6691 85	37564	1
		100	6691 76	32308	1	6691 86	37564	1
		160	6691 77	36812	1	6691 87	45078	1
		250	6691 78	43576	1	6691 88	54092	1
	DRX 630	320	6699 21	54740	1	6699 26	62978	1
		400	6699 22	54740	1	6699 27	62978	1
630		6699 24	59232	1	6699 29	73260	1	
50 KA	DRX 250 <sup>HP</sup>	40	6691 95	35312	1	6692 05	41870	1
		100	6691 96	35312	1	6692 06	41870	1
		160	6691 97	42072	1	6692 07	49952	1
		250	6691 98	47332	1	6692 08	55830	1
	DRX 630	320	6699 31	56644	1	6699 36	68356	1
		400	6699 32	56644	1	6699 37	68356	1
630		6699 34	61136	1	6699 39	76252	1	



6691 98

■ Price available on request.

\* MRP - Maximum Retail Price Inclusive of all taxes including GST.

Bold Cat.Nos are products normally available with Legrand (India) Stockists. Cat.Nos that are not bold - delivery within 4 - 8 weeks from the date of order. Bold packing quantity is our mandatory packing. Orders to be placed by Legrand (India) Stockist in multiples of the same.

## DRX MCCB

### DRX MCCB Accessories

**NEW!**

Shunt Release	Voltage	CAT No.	MRP* ₹ / Unit	Pack
---------------	---------	---------	------------------	------

#### Internal Accessories

DRX 125HP	240V AC	0271 54	2160	1
DRX 250HP				
DRX 630	240V AC	4222 42	2796	1
DRX 125HP	415V AC	0271 55	2160	1
DRX 250HP				
DRX 630	415V AC	4222 43	2796	1

Undervoltage Release	Voltage	CAT No.	MRP* ₹ / Unit	Pack
----------------------	---------	---------	------------------	------

DRX 125HP	240V AC	0271 64	3000	1
DRX 250HP				
DRX 630	240V AC	4222 48	3926	1
DRX 125HP	415V AC	0271 65	3000	1
DRX 250HP				
DRX 630	415V AC	4222 49	3926	1

Auxiliary Contact	Type	CAT No.	MRP* ₹ / Unit	Pack
-------------------	------	---------	------------------	------

DRX 125HP	1 C/O	0271 40	1000	1
DRX 250HP				
DRX 630	1 C/O	4210 11	1188	1



\* MRP - Maximum Retail Price Inclusive of all taxes including GST.  
 ■ Price available on request.

## DRX MCCB

### DRX MCCB Accessories

**NEW!**

Trip Alarm Contact	Type	CAT No.	MRP* ₹ / Unit	Pack
--------------------	------	---------	------------------	------

DRX 125HP	1 C/O	0271 41	1000	1
DRX 250HP				
DRX 630	1 C/O	4210 11	1188	1

Auxiliary + Trip Alarm Combo	Type	CAT No.	MRP* ₹ / Unit	Pack
------------------------------	------	---------	------------------	------

DRX 125HP	1 Aux + 1 Trip	0271 42	1750	1
DRX 250HP				

#### External Accessories

Rotary Handles	Type	CAT No.	MRP* ₹ / Unit	Pack
----------------	------	---------	------------------	------

DRX 125HP	Direct	6687 70	1170	1
DRX 250HP	Direct	6687 72	1170	1
DRX 630	Direct	6687 80	2050	1
DRX 125HP	Vary Depth	6687 71	1850	1
DRX 250HP	Vary Depth	6687 73	1850	1
DRX 630	Vary Depth	6687 81	3450	1

Bold Cat.Nos are products normally available with Legrand (India) Stockists. Cat.Nos that are not bold - delivery within 4 - 8 weeks from the date of order. Bold packing quantity is our mandatory packing. Orders to be placed by Legrand (India) Stockist in multiples of the same.

Spreader	Type	CAT No.	MRP* ₹ / Unit	Pack
DRX 125HP	3P One Side	6250 10	240	1
DRX 250HP	3P One Side	6250 14	750	1
DRX 630	400A 3P One Side	4226 31	1500	1
	630A 3P One Side	6250 04	1750	1
DRX 125HP	4P One Side	6250 11	340	1
DRX 250HP	4P One Side	6250 18	1000	1
DRX 630	400A 4P One Side	4226 32	2000	1
	630A 4P One Side	6250 08	2250	1

Phase Barriers	Type	CAT No.	MRP* ₹ / Unit	Pack
DRX 125HP	3P One Side	6693 00	150	1
DRX 250HP				1



0271 80

Phase Barriers	Type	CAT No.	MRP* ₹ / Unit	Pack
DRX 630	3P One Side	0262 30	224	1
DRX 125HP	4P One Side	6693 01	196	1
DRX 250HP				1
DRX 630	4P One Side	0262 30	224	1

Key Locks	Type	CAT No.	MRP* ₹ / Unit	Pack
For DRX 125HP/250HP suitable for				
Random	A	6687 74	2366	1
Direct Handle	B	6687 75	2366	1
Direct Handle	B	6687 76	2366	1
For DRX 125HP/250HP suitable for Vary Depth Handle				
Random	A	6687 77	2324	1
A	B	6687 78	2324	1
B	B	6687 79	2324	1
For DRX 630 suitable for Vary Depth Handle				
Random	A	6687 82	2324	1
A	B	6687 83	2324	1
B	B	6687 84	2324	1

Padlocks	Type	CAT No.	MRP* ₹ / Unit	Pack
DRX 125HP	-	0271 80	158	1
DRX 250HP	-	0271 80	158	1
DRX 630	-	0262 40	2290	1

\* MRP - Maximum Retail Price Inclusive of all taxes including GST.  
 ■ Price available on request.

Bold Cat.Nos are products normally available with Legrand (India) Stockists. Cat.Nos that are not bold - delivery within 4 - 8 weeks from the date of order. Bold packing quantity is our mandatory packing. Orders to be placed by Legrand (India) Stockist in multiples of the same.

# LBPLUS DATA



## LIGHTING BUSBAR FOR EFFICIENT LIGHTING MANAGEMENT

### SIMPLIFIED INSTALLATION FOR INCREASED PERFORMANCE



#### ENERGY EFFICIENCY

Integrate with dimming systems and lux meters for daytime electricity savings



#### SIMPLICITY WITH COMFORT

Completely addressable system for user convenience and remote management



#### MAXIMUM FLEXIBILITY OF USE

The certified protocols that can be used with LBplus data are the DALI and the 1-10 V protocols.



#### ENVIRONMENT SUSTAINABILITY

With the reduction of energy consumption, there is also an important reduction in the emission of polluting gases in the atmosphere. Renewable energy sources are not the only mean for reaching the environmental sustainability objectives: the starting point is certainly the reduction of existing consumptions



#### ENERGY SAVING

With LBplus data there is a reduction of both energy consumption due to artificial illumination (upto 75%, according to UNIEN 15193), and energy waste, thanks to the automatic management of lighting



#### COMPLIANCE WITH THE STANDARDS

With LBplus data, compliance with the EU Directives on energy efficiency both for new and for refurbished buildings is ensured





## APPLICATIONS / CAN BE USED AT



SHOPPING CENTRES,  
STORES, OFFICES...



WAREHOUSES, GYMS,  
UNDERGROUND car parks...



HOSPITALS,  
LABORATORIES...



WORKSHOPS, MAINTENANCE & REPAIR  
FACILITIES, PRODUCTION SITES...



Scan to know more about  
the product.

# IP68 RCP

## RESIN BUSBAR TRUNKINGS



## A SOLUTION THAT ADAPTS TO INDOOR AND OUTDOOR INSTALLATIONS

The **RCP IP68** resin busbar trunking system is a solution mainly for outdoor in extreme conditions such as humidity, corrosion or saline mist environment and temporary immersion risks.

### RCP IP68 Resin Busbar

New resin busbar RCP with range from 630 A to 6300 A and IP68 degree of protection represents the complete solution for the **transport** of high-power energy.

This new product is made with internal conductors in aluminium or copper and completely embedded in **a epoxy resin**, which provides mechanical strength and electrical insulation. With RCP is possible to provide specific solutions in different environments (outdoor and indoor) where it isn't possible to reach with busbar IP55.



Scan to know more about the product.

DEGREE OF PROTECTION

# IP68

**1ST DIGIT IP**  
Protection against penetration of solid bodies

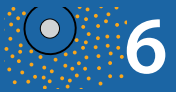

Complete protection against dust

**2ND DIGIT IP**  
Protection against penetration of liquids

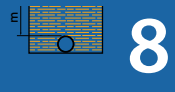

Protection against effects of Immersion under pressure  
(At maximum of 1m, as comply by standard EN 61439-6)

**BUSBAR TRUNKING**

- Resin built-in conductors.
- Insulations of single conductors in polyester film.
- Fully insulated with epoxy resin.
- Rated current between 630 - 6300 A.
- Insulation voltage up to 1000 V.
- Small dimensions.
- Maintenance free.
- Only for Transport of energy.

**CONDUCTOR MATERIAL**

- Copper: copper busbars with a purity greater than 99.9% .
- Aluminium: aluminium alloy busbars, with entire surface treated with different galvanic processes.
- Degree of protection: IP68 according to the EN 61439-6.

## Typical applications

The typical applications of IP68 busbar trunkings are



Industrial plants



Petrochemical plants



Chemical plants (\*).



Outdoor (in different extreme conditions).

(\* attention at chemical components which are not compatible with the busbar's resin



# DSX

SAFETY, STRENGTH  
AND EASE OF  
INSTALLATION



New range for power  
switching needs of  
modern installation

ON A DIN RAIL

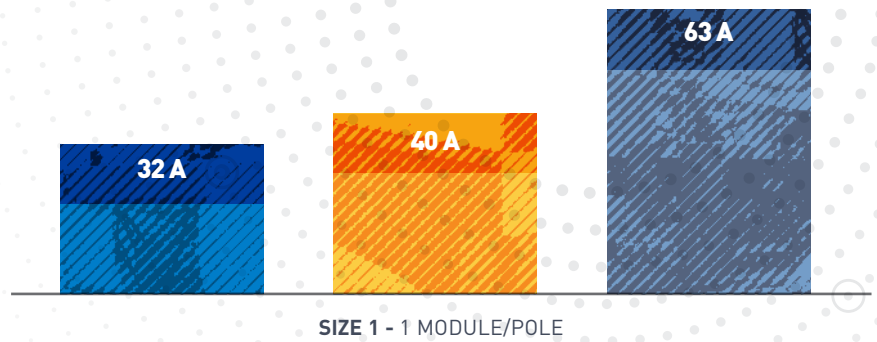

ON A PLATE

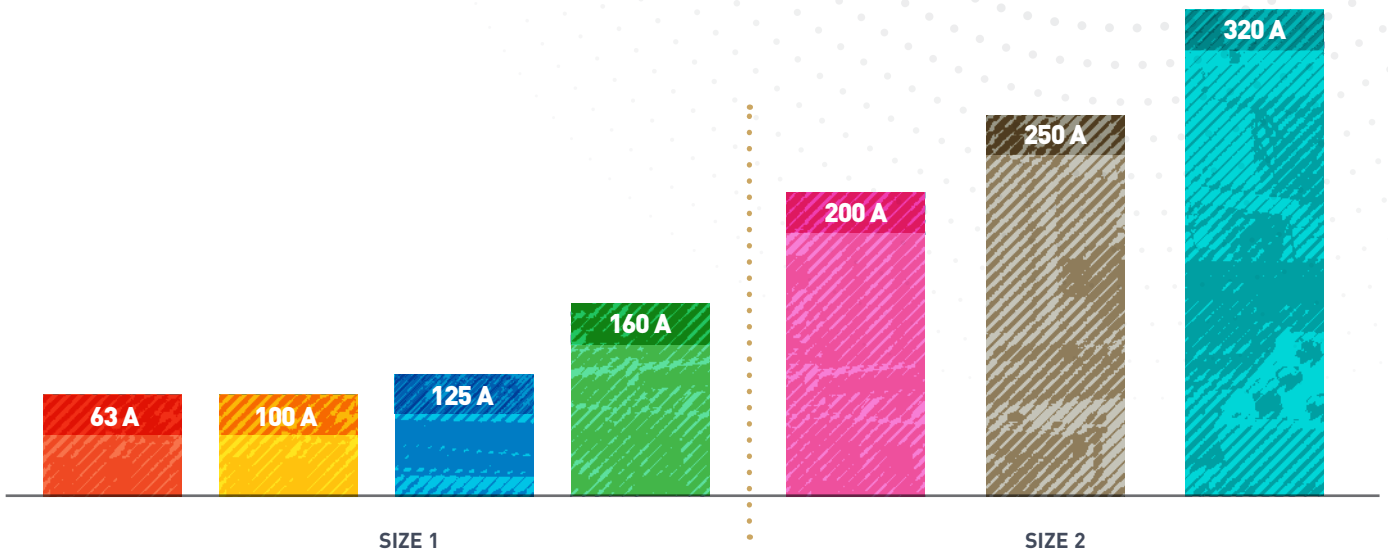

Scan to know more about  
the product.



Features:

- Operational Voltage upto 690V AC
- High Electrical and Mechanical Life
- Patented Features - Pop Ind & Visual Contacts
- Best in class accessories

Modular

SD



SD DIN LINE

TSE



TSE DIN LINE

Plate Mounted



SD POWER LINE



TSE POWER LINE





# DSX

NEW RANGE FOR POWER SWITCHING NEEDS OF MODERN INSTALLATIONS

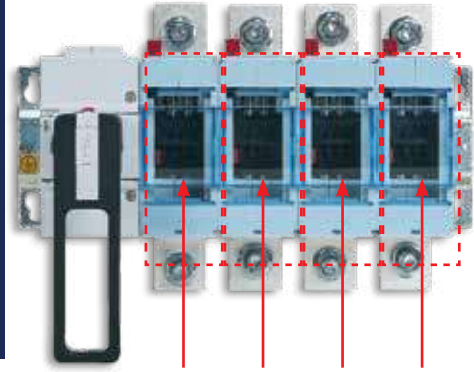

The physical separation of the main contacts is visible through a transparent cover.



Pop up indicators

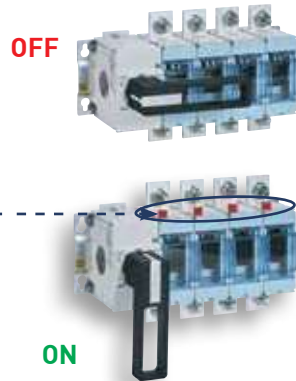

Innovative Design



Safe



Ease of Installation



Robust

## BEST IN CLASS ACCESSORIES FOR SAFETY AND PERFORMANCE

Accessories:



## DSX SD/TSE

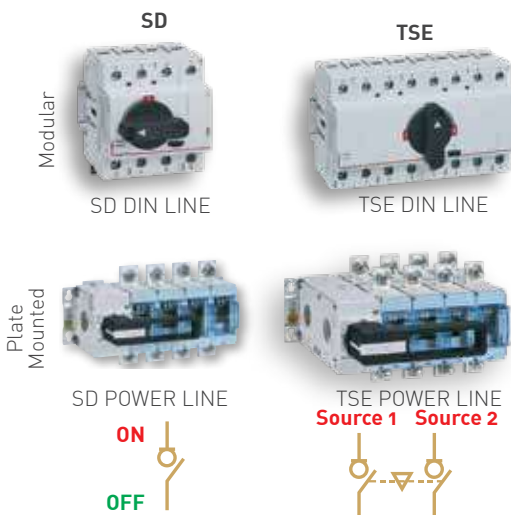

Frame -->	DIN LINE 1	POWER LINE 1	POWER LINE 2
Ratings	32A, 40A, 63A	63A, 100A, 125A, 160A	200A, 250A, 320A
Rated Operational Voltage, U <sub>e</sub>	690V ac	690V ac	
Rated Insulation Voltage, U <sub>i</sub>	690V ac	1000V ac	
Rated Impulse Voltage, U <sub>imp</sub>	8kV	8kV	12kV
Mechanical Life	10000@	10000	10000
Electrical Life	2000	2500	2000
Icw for 1 sec	1.5kA	8kA	12.5kA

@12000 for DIN LINE 1 SD/ 10000 for DIN LINE 1 TSE

Type	Rated Current (A)	Switch Disconnecter			TSE (Changeover Switch)			TSE (Changeover Switch) with Enclosure		
		Cat.Nos	MRP*/₹/Unit	Pack	Cat.Nos	MRP*/₹/Unit	Pack	Cat.Nos	MRP*/₹/Unit	Pack
DIN Line Frame 1 (3P + N)	32A	424006	3120	1	424106	5580	1			
	40A	424007	3270	1	424107	5830	1			
	63A	424008	3890	1	424108	6800	1			
POWER Line Frame 1 (4P)	63A	424082	4650	1	424182	7720	1	424192	11510	1
	100A	424083	8590	1	424183	10280	1	424193	14830	1
	125A	424084	10540	1	424184	14020	1	424194	17030	1
	160A	424085	14220	1	424185	15960	1	424195	21940	1
POWER Line Frame 2 (4P)	200A	424086	15450	1	424186	20720	1	424196	25420	1
	250A	424087	18060	1	424187	29460	1	424197	35290	1
	320A	424088	19950	1	424188	30180	1	424198	36980	1

## Accessories

	DIN LINE 1			POWER LINE 1			POWER LINE 2		
	Cat.Nos	MRP*/₹/Unit	Pack	Cat.Nos	MRP*/₹/Unit	Pack	Cat.Nos	MRP*/₹/Unit	Pack
Shorting Links for TSE (set of 4)	424201	870	1						
Terminal Shield IP20 - 3P#	424202	360	1						
Terminal Shield IP20 - 1P#	424203	280	1						
Auxiliary contact (1 NO + 1 NC)	424208	460	1						
Vary Depth Handle	424209	1278	1						
Auxiliary contact (1 NO + 1 NC)	424245	1278	1	424245	1278	1			
Aux Contact (1NO+1NC) Early Make/Break	424244	1500	1	424244	1500	1			
Spreaders Terminals (One Side i.e. Set of 4)	424254	1000	1	424238	2000	1			
Terminal Shield IP20 - 4P	424247	1022	1	424236	1176	1			
Phase Barriers	424251	204	1	424243	256	1			
Inter Source Barrier	424252	256	1	424239	410	1			
Shorting Links for TSE (set of 4)	424249	2456	1	424241	3682	1			
Direct Handle	424230	1074	1	424230	1074	1			
Vary Depth Handle	424231	1534	1	424231	1534	1			
Direct Key Lock	424234	1074	1	424234	1074	1			

# To be Ordered together as 1 set for 4P SD and 2 sets for 4P TSE.

SD POWER LINE --> Packaging Includes SD, Phase Barriers, Vary Depth Handle.

TSE POWER LINE --> Packaging Includes TSE, Phase Barriers, Inter Source Barrier, Vary Depth Handle, Shorting Links.

## E-communicating Infrastructure

Cat.Nos	Description	MRP* ₹ / Unit	Pack
---------	-------------	------------------	------

### Power Supervision System

Remote control, Monitoring and Measurement

### Communication Accessories for ACB

0288 05	Communication option - for DMX <sup>3</sup> electronic protection units (Factory Fitted)	■	1
0288 06	Power supply - external - 12 V DC - for DMX <sup>3</sup> electronic protection units	■	1



0288 06

### Communication Modules

#### Modules programmable output

#### Features

Programmable electronic device capable of controlling 6 relay outputs. The device can work in three different ways, with DMX<sup>3</sup>, with DPX<sup>3</sup> or as Independent module depending on the product it is associated with

#### 6 Programmable relay outputs with 230 V, 8 A contacts

Communication is ensured by the Modbus protocol.

0288 12	Modules programmable output	■	1
---------	-----------------------------	---	---



0288 12

### Signalling and control interface

#### Features

Signalling and control interface between the power supervision system and the **thermal magnetic or electronic circuit breakers**.

Equipped with analogue / digital inputs and relay outputs.

Can handle multiple circuit breakers.

**24 inputs for collecting information** from the signalling auxiliaries on the DPX<sup>3</sup> and DMX<sup>3</sup> circuit breakers: auxiliary contact NO position (1 input) or

## E-communicating Infrastructure

Cat.Nos	Description	MRP* ₹ / Unit	Pack
---------	-------------	------------------	------

NO+NC position (2 inputs), fault signal (1 input)

#### 6 outputs for: the remote control of the motor

**driven circuit breakers** (2 outputs) and for tripping the circuit breakers (1 output)

Communication is ensured by the Modbus protocol.

Address, speed and coding can be modified with configuration kit.

0261 36	Signalling and control interface	■	1
---------	----------------------------------	---	---



0261 36

### Communication accessories for MCCB

#### Features

RS485 communication interface

#### Potential free contact for circuit breaker tripped

#### status information max. 220 V 0.2 A

4210 75	DPX <sup>3</sup> electronic interface For connecting electronic DPX <sup>3</sup> to an RS485 Modbus communication network Note: 24 V <sub>DC</sub> is required to power up the module	■	1
4210 83	Auxiliary power supply for DPX <sup>3</sup> - 24 V <sub>AC</sub> - 250 mA Can be used to power upto 8 breakers	■	1



4210 75



4210 83

### Communication accessories for MCB

#### Features

RS485 communication interface

#### Potential free contact for circuit breaker tripped

#### status information max. 220 V 0.2 A

Can be connected with DX3 add on Modules (4106 57/58/59)

4210 75	DPX <sup>3</sup> electronic interface For connecting electronic DPX <sup>3</sup> to an RS485 Modbus communication network Note: 24 V <sub>DC</sub> is required to power up the module	■	1
---------	---	---	---

\* MRP - Maximum Retail Price Inclusive of all taxes including GST.  
(1) Price in Meters; No of meters in Pack, Standard length 2 meters to be ordered in multiple of 2 meters.

Bold Cat.Nos are products normally available with Legrand (India) Stockists. Cat.Nos that are not bold - delivery within 4 - 8 weeks from the date of order. Bold packing quantity is our mandatory packing. Orders to be placed by Legrand (India) Stockist in multiples of the same.

## E-communicating Infrastructure

Cat.Nos	Description	MRP* ₹ / Unit	Pack
---------	-------------	------------------	------

### Panel Board Display

Optional touch screen allowing to:

Visualize information coming from DX<sup>3</sup>, DPX<sup>3</sup> and DMX<sup>3</sup> protection devices and EMDX<sup>3</sup> multi-function measuring units and Can manage up to 9 devices

Power supply: 18-30 V=

IP connection

For mounting on door or solid faceplate

Door cut: 92 x 92 mm



0261 56

0261 56	Door mounting touch screen	21696	1
---------	----------------------------	-------	---

**NEW!**

### Communication accessories



0261 45

0261 45	Configurator kit For configuring the DPX and DPX <sup>3</sup> I/O card and interface Kit with configurators 0 to 9 (10 configurators for each digit)	■	1
0046 89	IP converter For RS 485/ Ethernet conversion for connecting electricity meters and measurement control units to an IP network	■	1
1466 23	Stabilised switched modules power supply- single phase -75-960 W-output 24 V= -120 W	■	1



0046 89



1466 23

### Energy management software for 1 computer

#### (user licence key)

Allows remote configuration, test, control and visualization of data 30-day free trial version

## E-communicating Infrastructure

Cat.Nos	Description	MRP* ₹ / Unit	Pack
---------	-------------	------------------	------

available for download via E-Catalogue

4149 38	Software licence agreement (user key) for 32 Modbus addresses or 32 pulse modules	■	1
4149 39	Software licence agreement (user key) 255 Modbus addresses or 255 pulse modules	■	1

**NEW!**

### Energy management multi-support web servers

Allow remote configuration, test, control and visualization, via a web browser on PCs, smartphones, web viewers, tablet computers, of data Converter

#### Features

#### In-built IP convertor

Power supply: 9 to 28 V= with the help of a single-phase switching mode power supply Cat.No 1467

21 to be ordered separately. With the Legrand

Power supervision system, circuit breakers are integrated in a supervision system

You can therefore check the status of the circuit breakers, measure the electrical values and control the circuit breakers remotely.

MODBUS protocol



4149 48

4149 47	For 10 Modbus addresses or 10 pulse modules	■	1
4149 48	For 32 Modbus addresses or 32 pulse modules	■	1
4149 49	For 255 Modbus addresses or 255 pulse modules Supplied with external power supply and fixing brackets	■	1

\* MRP - Maximum Retail Price Inclusive of all taxes including GST.  
(1) Price in Meters; No of meters in Pack, Standard length 2 meters to be ordered in multiple of 2 meters.

Bold Cat.Nos are products normally available with Legrand (India) Stockists. Cat.Nos that are not bold - delivery within 4 - 8 weeks from the date of order. Bold packing quantity is our mandatory packing. Orders to be placed by Legrand (India) Stockist in multiples of the same.

# COMMUNICATION ARCHITECTURE

## PROTECTION

## MEASUREMENT

## CONTROL AND SIGNALLING

RESIDENTIAL

DX<sup>3</sup> Ph+N MCBs



408614 408590

EMDX<sup>3</sup> energy meters



4120 45 4120 81 4120 91

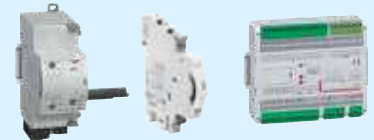

406295 406252 026136

Auxiliaries and motorised control + I/O interface

COLLECTIVE HOUSING AND SMALL OFFICE BUILDINGS

DX3 MCBs



408614 408590

EMDX<sup>3</sup> measuring units

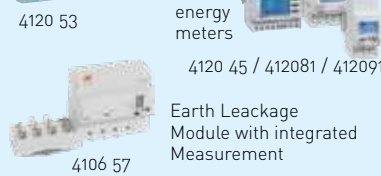

4120 53 EMDX<sup>3</sup> energy meters 4120 45 / 412081 / 412091 Earth Leakage Module with integrated Measurement 4106 57

Cx3 EMS modules:

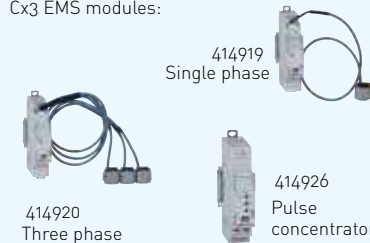

414919 Single phase 414926 Pulse concentrator

CX3 EMS signalling and control modules



414929 / 414930 / 414932

CX3 EMS signalling and control modules



414931

CX3 + DX3 MCBs



4086 94 4125 56

EMDX<sup>3</sup> measuring units

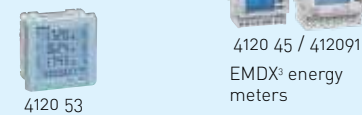

4120 53 4120 45 / 412091 EMDX<sup>3</sup> energy meters

Auxiliaries and motorised control

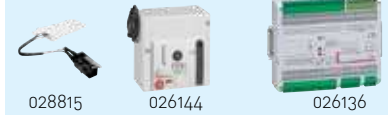

028815 026144 026136

Auxiliaries and motorised controls



028815 026144

CX3 EMS signalling and control modules



414929 / 414932

COMMERCIAL AND INDUSTRIAL



420010

DPX3 MCCBs



028696

DMX3 MCCBs

CX3 EMS measuring module



414923

Electronic DPX3 with integrated measurement



028803

DMX3 with electronic Protection unit



**COMMUNICATION**

**REMOTE**

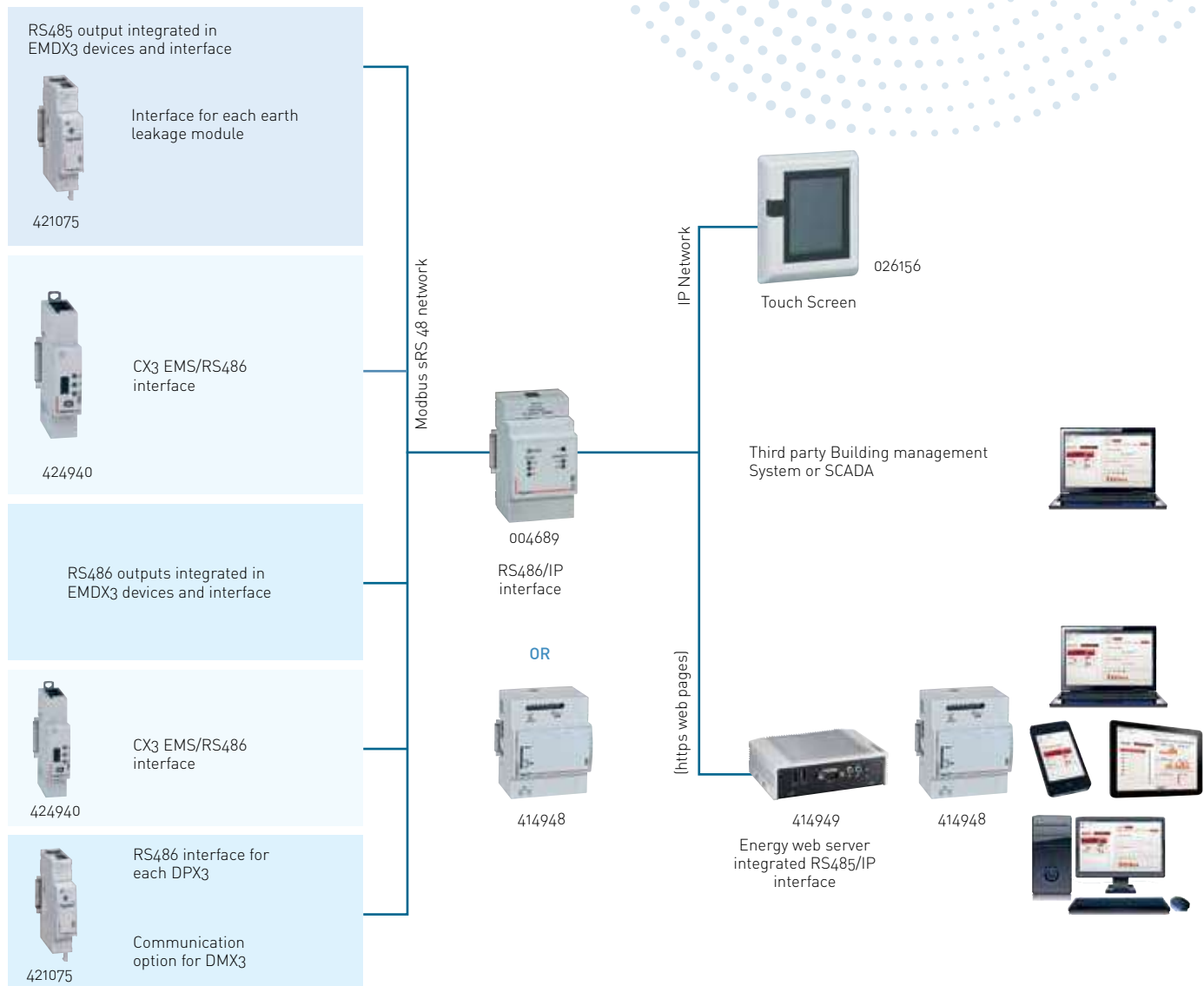

## Power Supply

NEW!

Cat.Nos	Description	MRP* ₹ / Unit	Pack
<p><b>Generic Power Supply for all your conversion needs from AC to DC</b></p> <p><b>Features</b>                      Conform to standards UL 508, UL 60950, EN 61558-2-16 and IEC EN 60950-1, EN 55022 class B, EN 61000-3-2, EN 61000-3-3, EN 61000-6-2 and EN 61204-3                      Operating frequency: 50/60 Hz                      Output voltage present indicator                      Output voltage adjustment potentiometer on front panel                      Integrated short-circuit and overload protection                      For mounting on a symmetrical rail depth 7.5 mm and 15 mm</p>			
1467 01	Single-phase switching modules power supply - 15 W - input 100-240 V~ / output 5 V=	5232	1
1467 11	Single-phase switching modules power supply - 24 W - input 100-240 V~ / output 12 V=	5668	1

\* MRP - Maximum Retail Price Inclusive of all taxes including GST.  
 (1) Price in Meters; No of meters in Pack, Standard length 2 meters to be ordered in multiple of 2 meters.

## Power Supply

NEW!

Cat.Nos	Description	MRP* ₹ / Unit	Pack
1467 12	Single-phase switching modules power supply - 54 W - input 100-240 V~ / output 12 V=	6264	1
1467 21	Single-phase switching modules power supply - 15 W - input 100-240 V~ / output 24 V=	5838	1
1467 22	Single-phase switching modules power supply - 36 W - input 100-240 V~ / output 24 V=	5886	1
1467 23	Single-phase switching modules power supply - 60 W - input 100-240 V~ / output 24 V=	6432	1
1467 24	Single-phase switching modules power supply - 92 W - input 100-240 V~ / output 24 V=	6956	1



1467 21

**Bold Cat.Nos** are products normally available with Legrand (India) Stockists. Cat.Nos that are not bold - delivery within 4 - 8 weeks from the date of order. **Bold packing quantity** is our mandatory packing. Orders to be placed by Legrand (India) Stockist in multiples of the same.

# Switching Mode Power Supplies

single-phase

Generic power supply for all your conversion needs from AC to DC

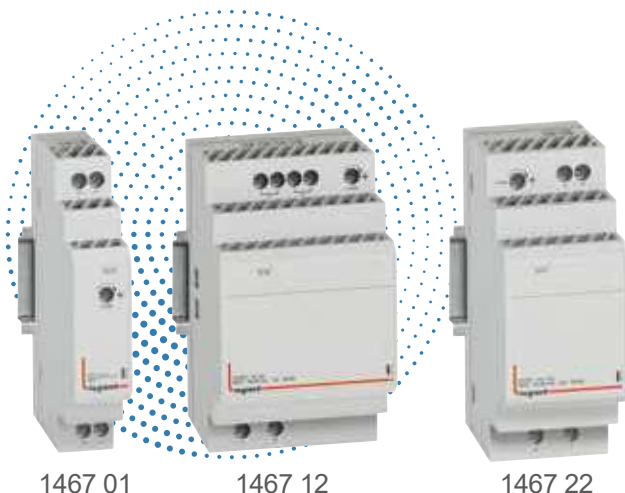

1467 01

1467 12

1467 22

UL 508 approvals  
 conforming to IES EN 60950-1, EN 61558-2-16  
 Conforming to EN 55022 class B\*, EN 61000-3-2 class A, EN 61000-3-3  
 Conforming to EN 61000-4-2, 3, 4, 6 Level 3, criterion A  
 EN 61000-4-5 and 8 level 4, criterion A  
 EN 61204-3  
 \*Class B means the power supply can be used in any environment, including residential

### Features

- Operating frequency: 50/60 Hz
- Integrated short-circuit and overload protection on the power supply secondary
- Class II insulation
- Output voltage present indicator
- Output voltage adjustment potentiometer on front panel
- Output voltage variation: ±1%
- No-load power consumption less than 0.3w
- Cooling by natural convection
- Modular product

# EMDX<sup>3</sup>

SMART  
ELECTRICITY  
METERS



SUSTAINABLE SAVINGS  
FOR YOUR INSTALLATIONS



A meter should be selected according to the network (single-phase or three-phase) and its maximum current, required displayed values and communication type allowing it to be run by a supervision system.

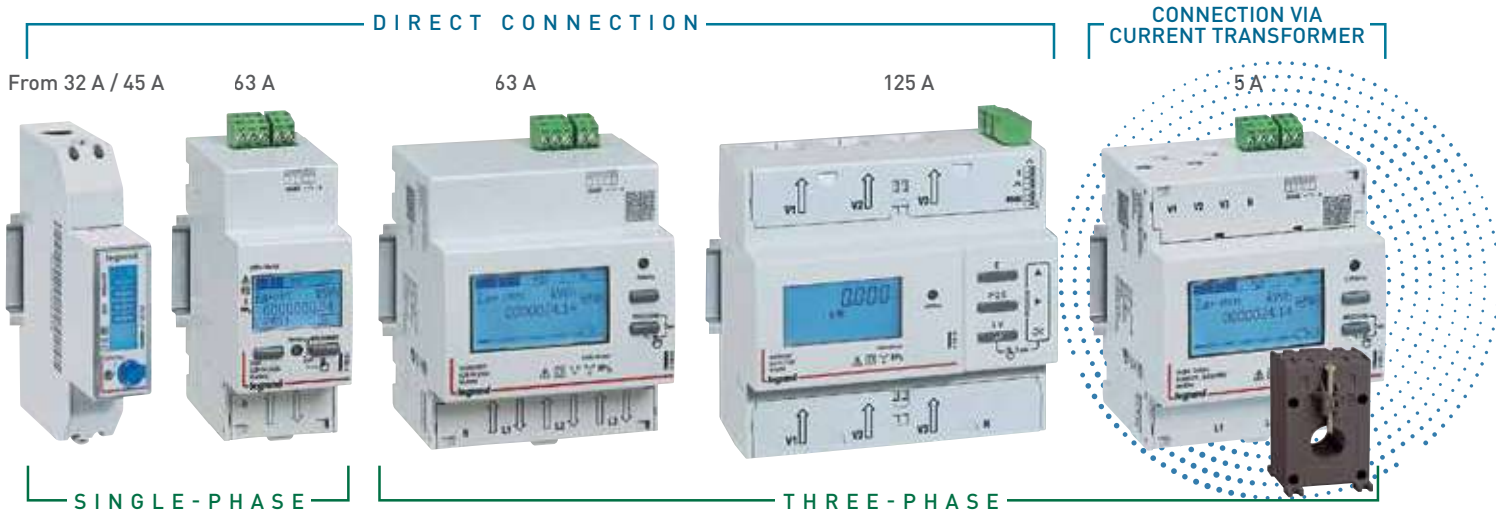

Conforming to standards IEC 61557-12, IEC 62053-21/23, IEC 62052-11, IEC 62052-31, EN 50470-1/3 (for the MID version)

	Cat.No	I <sub>max</sub> (A)	Width (number of modules)	Non-MID	MID	Output		Dual Tariff	WAGES (Pulse Input)
						Modbus (RS 485)	Pulse		
	0 046 70	32	1	x			x		
	4 120 68	45	1	x		x			
	4 120 69	45	1		x		x		
	4 120 80	63	2	x			x		x
	4 120 81	63	2	x		x		o	o
	4 120 82	63	2		x		x		x
	4 120 83	63	2		x	x		o	o
	4 120 90	63	4	x			x		x
	4 120 91	63	4	x		x		o	o
	4 120 92	63	4		x		x		x
	4 120 93	63	4		x	x		o	o
	4 120 74	125	6	x		x	x	x	
	4 120 75	125	6		x	x	x	x	
	4 120 40	5	4	x			x		x
	4 120 41	5	4	x		x		o	o
	4 120 42	5	4		x		x		x
	4 120 43	5	4		x	x		o	o

New range

x Built-in

o Dual tariff or 1 pulse input for other meters to connect (water, gas etc.)

The Dual Tariff function allows energy consumption to be measured during different time slots (peak period, off-peak period) or record energy use from two different sources (EB or DG) with a single meter.



Scan to know more about the product.



## EMDX<sup>3</sup> Multi-function meters for Smart Distribution Board

**NEW!**

### Din rail mounting

Din Rail Meters for Smart Distribution Board. LCD meter with bright graphical back lit display. 1P / 3P Direct connection or connection with CT. Measures kWh as well as other values like current, voltage, active energy, power etc.

Confirms to Standards: IEC 61557-12; IEC 62053-21/23; IEC 62052-11 and IEC 62052-31

MID\* compliance ensures accuracy for billing

### Dual Tariff meters

WAGES Enabled (1 Pulse input to connect water meter, gas meter etc.)

\*MID - Measuring Instruments Directive. The meters comply to MID, ensures the highest levels of reliability and transparency, and in order to provide complete metrological assurance, applications that necessitate the installation of meters dedicated to invoicing purposes.

### Direct Connection Single Phase

Cat. Nos	Current Rating (A)	Description	No. of Modules	MRP* ₹ / Unit	Pack
0046 70	32	32A 1P Energy Meter with Pulse Output	1	■	1
4120 68	45	45A 1P Multi Function Meter with RS-485	1	■	1
4120 69	45	45A 1P Multi Function Meter with Pulse Output - MID	1	■	1
4120 80	63	63A 1P Multi Function Meter with WAGES & Pulse Output	2	■	1
4120 82	63	63A 1P Multi Function Meter with WAGES & Pulse Output - MID	2	■	1
4120 81	63	63A 1P Multi Function Meter with Dual Tariff / WAGES & RS-485	2	■	1
4120 83	63	63A 1P Multi Function Meter with Dual Tariff / WAGES & RS-485 - MID	2	■	1



4120 80

### Direct Connection

#### Three Phase

4120 90	63	63A 3P Multi Function Meter with WAGES & Pulse Output	4	■	1
4120 92	63	63A 3P Multi Function Meter with WAGES & Pulse Output - MID	4	■	1
4120 91	63	63A 3P Multi Function Meter with Dual Tariff / WAGES & RS-485	4	■	1
4120 93	63	63A 3P Multi Function Meter with Dual Tariff / WAGES & RS-485 - MID	4	■	1
4120 74	125	125A 3P Multi Function Meter with Dual Tariff / WAGES, RS-485 & Pulse Output	6	■	1
4120 75	125	125A 3P Multi Function Meter with Dual Tariff / WAGES, RS-485 & Pulse Output - MID	6	■	1



4120 91

## EMDX<sup>3</sup> Multi-function meters for Smart Distribution Board

**NEW!**

Cat. Nos	Current Rating (A)	Description	No. of Modules	MRP* ₹ / Unit	Pack
----------	--------------------	-------------	----------------	---------------	------

### Connection with CT

4120 40	5	3P with CT Multi Function Meter with WAGES & Pulse Output	4	■	1
4120 42	5	3P with CT Multi Function Meter with WAGES & Pulse Output - MID	4	■	1
4120 41	5	3P with CT Multi Function Meter with Dual Tariff / WAGES & RS-485	4	■	1
4120 43	5	3P with CT Multi Function Meter with Dual Tariff / WAGES & RS-485 - MID	4	■	1

### Modular Multi Function Meter

LCD meter with bright graphical back lit display. 4 Dedicated Keys (V / I / P Q S / E P F F) Precision class 1 / 0.5

Connection with current transformers (CT)

Measurement of currents, voltages, frequency, active, reactive and apparent power, power factor, active and reactive energy

4 tariff metering THD voltages, currents and harmonic analysis up to order 25th (available on Modbus COM port)

Programmable alarms on all functions

RS 485 and pulse output

Phase sequence correction diagnostic

Customized display page

Cat. Nos	Current Rating (A)	Description	No. of Modules	MRP* ₹ / Unit	Pack
----------	--------------------	-------------	----------------	---------------	------

4120 45	5	Modular Multi Function Meter with THD - RS-485 & Pulse Output CI 1	4	■	1
4120 51	5	4 Tariff Modular Multi Function Meter with Individual THD, Programmable alarms - RS-485 & Pulse Output CI 0.5	4	■	1



4120 51

### Pulse concentrator

For collecting and transmitting measurements taken by 12 universal pulse electricity meters.

Collects pulses from other meters (gas meters, water meters, etc.) RS-485 output

Cat. Nos	Description	No. of Modules	MRP* ₹ / Unit	Pack
----------	-------------	----------------	---------------	------

4120 65	Pulse Concentrator	4	■	1
---------	--------------------	---	---	---



4120 65

### EMDX<sup>3</sup> Digital Panel Meter

For mounting on door or solid faceplate

Dimensions: 96 x 96 x 62 mm

LCD meter with bright graphical back lit display.

4 Dedicated Keys (V / I / P Q S / E P F F)

Measurement of currents, voltages, active, reactive and apparent power and power factor

Bold Cat.Nos are products normally available with Legrand (India) Stockists. Cat.Nos that are not bold - delivery within 4 - 8 weeks from the date of order. Bold packing quantity is our mandatory packing. Orders to be placed by Legrand (India) Stockist in multiples of the same.



## EMDX<sup>3</sup> Digital Panel Meter

Cat. Nos	Description	MRP <sup>*</sup> ₹ / Unit	Pack
----------	-------------	---------------------------	------

### Metering:

- Active energy consumed or produced
- Reactive energy consumed or produced
- Operating time
- Pulses
- THD voltages, currents, and individual harmonic up to order 25(1)
- RS 485 communication and Pulse output
- Phase sequence correction diagnostic
- Optorelays with potential-free SPST-NO contact
- Customized display page



4120 52

4120 47	Multi Function Meter with THD - RS-485 & Pulse Output CI 1	■	1
4120 52	Advance Multi Function Meter with Individual THD - RS-485 & Pulse Output CI 0.5	■	1

## Power Quality & Network Analyzer with Data Logger

**Dimensions:** 96 x 96 x 62 mm

LCD meter with bright graphical back lit display.

Customized display page

4 Dedicated Keys (V / I / P Q S / E P F F)

Precision class: 0.5

Measurement of currents, voltages, active, reactive and apparent power, internal temperature and power factor

### Metering:

- active energy consumed or produced
- Reactive energy consumed or produced
- Operating time
- THD
- Programmable alarms on all functions
- Power quality functions: harmonics (U & I) to 50th, dips, swells, interruption, rapid voltage change and flickers
- Memory embedded (8 Mb)
- RTC (real time clock)
- Can take 4 EMDX3 optional modules



4120 53

Cat. Nos	Description	MRP <sup>*</sup> ₹ / Unit	Pack
4120 53	Power Quality & Network Analyzer with Data Logger	■	1
4120 55	R485 communication module with Modbus link	■	1
4120 59	2 Pulse output module for energy count	■	1
4120 57	2 inputs / 2 outputs module	■	1
4120 60	2 analog outputs module	■	1
4120 58	Temperature module	■	1

**NEW!**



0046 89

## Communication interface

Cat. Nos	Description	MRP <sup>*</sup> ₹ / Unit	Pack
----------	-------------	---------------------------	------

### RS485 / Ethernet

0046 89	IP converter For RS 485/Ethernet conversion for connecting electricity meters and measurement control units to an IP network	■	1
---------	---	---	---

### Energy management software for 1 computer (user licence key)

Allows remote configuration, test, control and visualization of data

30-day free trial version available for download via E-Catalogue

Cat. Nos	Description	MRP <sup>*</sup> ₹ / Unit	Pack
----------	-------------	---------------------------	------

4149 38	Software licence agreement (user key) for 32 Modbus addresses or 32 pulse modules	■	1
4149 39	Software licence agreement (user key) 255 Modbus addresses or 255 pulse modules	■	1



4149 38

### Energy management multi-support web servers

Allow remote configuration, test, control and visualization, via a web browser on PCs, smartphones, web viewers, tablet computers, of data

### Features

- In-built IP converter
- Power supply: 9 to 28 V= with the help of a single-phase switching mode power supply Cat.No 1 467 21 to be ordered separately
- With the Legrand Power supervision system, circuit breakers are integrated in a supervision system
- You can therefore check the status of the circuit breakers, measure the electrical values and control the circuit breakers remotely
- MODBUS protocol

Cat. Nos	Description	MRP <sup>*</sup> ₹ / Unit	Pack
----------	-------------	---------------------------	------

4149 47	For 10 Modbus addresses or 10 pulse modules	■	1
4149 48	For 32 Modbus addresses or 32 pulse modules	■	1
4149 49	For 255 Modbus addresses or 255 pulse modules Supplied with external power supply and fixing" brackets	■	1



4149 48

Bold Cat.Nos are products normally available with Legrand (India) Stockists. Cat.Nos that are not bold - delivery within 4 - 8 weeks from the date of order. Bold packing quantity is our mandatory packing. Orders to be placed by Legrand (India) Stockist in multiples of the same.

# PMX

DIGITAL PANEL METERS

FOR ACCURATE  
MONITORING AND  
ENERGY SAVINGS.



## WHY IS PMX PERFECT FOR YOUR FACILITY?



### ROBUST

- ✓ Single function meter to advanced level MFM and demand controllers
- ✓ Ensures accurate wiring with ease
- ✓ Cost effective



### ADAPTABLE

- ✓ Universal control power supply
- ✓ Site selectable CT/PT ratios
- ✓ Seamless integration with EMS/SCADA

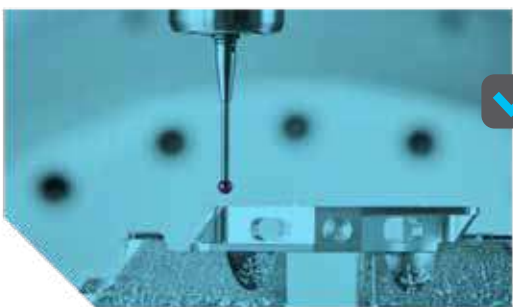

### PRECISE

- ✓ True RMS measurement
- ✓ High accuracy class 1 & class 0.5 s
- ✓ Detailed measurements with auto-scaling



Scan to know more about the product.

## PMX Digital Panel Meters

NEW!

Cat.Nos	Model Series	Description	MRP* ₹ / Unit	Pack
---------	--------------	-------------	------------------	------

### PMX 1000 precise single function meters

#### Features

- **RoHS Compliance**
- True RMS measurement
- High accuracy with class 1 as per IEC 62053-21
- Volts & Amps:  $\pm 1.0\%$  of Rated Current.
- **Bright 7 Segment LED display with four digit resolution and 14mm Height**
- Auto and Manual scrolling
- **Site selectable CT/PT ratios**
- Site selectable CT Secondary 1 A/5 A
- **Site selectable 3Phase 4Wire, 3Phase 3Wire & 1Ph configuration**
- Suitable for 50/60 Hz
- Wide range of control power supply 80 - 300 V AC, 40-70 Hz
- Low burden  $< 0.2$  VA per phase Volts & Amps
- Average & Phase wise measurements
- Password protection



4149 77



4149 78

<b>4149 75</b>	PMX 1100	1Ph Ammeter CI 1	1462	1
<b>4149 76</b>	PMX 1200	1Ph Voltmeter CI 1	1462	1
<b>4149 77</b>	PMX 1103	3Ph Ammeter CI 1	2118	1
<b>4149 78</b>	PMX 1203	3Ph Voltmeter CI 1 + Hz	2118	1

### PMX 4000 true VAF + PF meter

#### Features

- **RoHS Compliance**
- **Displays Current, line to neutral & line to line Voltages, frequency & Power Factor. (VA & PF - Phase Wise & Average)**
- **Display on Hours**
- True RMS measurement with simulations sampling of Current & Voltage
- High accuracy with class 1 as per IEC 62053-21 Volts & Amps:  $\pm 1.0\%$  of Rated Current.
- **3 Row Display with LED status for different parameter selection.**
- Auto and Manual scrolling
- Site selectable CT/PT ratios
- Site selectable CT Secondary 1 A/5 A
- Site selectable 3Phase 4Wire, 3Phase 3Wire & 1Ph configuration
- Suitable for 50/60 Hz
- Universal control power supply 80 - 300 V AC/DC, 40-70 Hz
- Low burden  $< 0.2$  VA per phase Volts & Amps
- Average & Phase wise measurements
- **Password protection**
- **Seamless integration with EMS/SCADA system with RS485 serial channel communication,**



4149 82

## PMX Digital Panel Meters

NEW!

Cat.Nos	Model Series	Description	MRP* ₹ / Unit	Pack
---------	--------------	-------------	------------------	------

### Industry standard Modbus RTU protocol.

<b>4149 79</b>	PMX 4000	3Ph VAF + PF meter CI 1	3704	1
<b>4149 80</b>	PMX 4000	3Ph VAF + PF meter CI 1 with RS485	4420	1



4149 80

### PMX 5000 smart energy meters for smart energy billing

#### Features

- **RoHS Compliance**
- kWh/kVA
- **Old Energy register for back up of last cleared energy values**
- Bright LED with parameter name and value
- Auto scaling capability in adjustment of Kilo, Mega, Giga.
- kWh / kVA / PF / W - any one programmable
- **Positive energy accumulation even with CT polarity reversal with reverse lock program**
- High Accuracy with class 1 as per IEC 62053-21
- Site selectable CT/PT ratios
- Site selectable CT Secondary 1 A/5 A
- Universal control power supply 80 - 300 V AC/DC, 40-70 Hz
- Password protection for tamper proofing
- **Seamless integration with EMS/SCADA system with RS485 serial channel communication, Industry standard Modbus RTU protocol.**
- **Pulse output for integration into a process through PLC/DCS for online energy management**
- Provision for Tamper proofing with meter casing\* \*optional strip for tamper proofing.

<b>4149 81</b>	PMX 5000	kWh LED meter CI 1	4160	1
<b>4149 82</b>	PMX 5000	kWh LED meter CI 1 with RS485	4798	1
<b>4149 83</b>	PMX 5000	kWh LED meter CI 1 with Pulse Output	5748	1

### PMX 6000 multi dual source meter

#### Features

- **RoHS Compliance**
- **Bright LED display for showing parameters for both EB & DG**
- **Displays full range of parameters**  
Basic : VLL, VLN, A (Avg. & Phase wise), F  
Power: W, PF (Avg. & Phase wise)  
Energy: Wh
- **Load Hours, Run Hours, Old Wh, Old Load Hours for both EB & DG.**
- **DG Sensing input - 230 VAC**
- Auto scaling capability in adjustment of Kilo, Mega, Giga.
- Positive energy accumulation even with CT polarity reversal with reverse lock program.
- High Accuracy with class 1 as per IEC 62053-21 & class 0.5 as per IEC 62053-22

Bold Cat.Nos are products normally available with Legrand (India) Stockists. Cat.Nos that are not bold - delivery within 4 - 8 weeks from the date of order. Bold packing quantity is our mandatory packing. Orders to be placed by Legrand (India) Stockist in multiples of the same.

## PMX Digital Panel Meters

NEW!

Cat.Nos	Model Series	Description	MRP* ₹ / Unit	Pack
---------	--------------	-------------	------------------	------

- Site selectable CT/PT ratios
- Site selectable CT Secondary 1 A/5 A
- Universal control power supply 80 – 300 V AC/DC, 40-70 Hz
- Password protection for tamper proofing
- **Seamless integration with EMS/SCADA system with RS485 serial channel communication, Industry standard Modbus RTU protocol.**
- Provision for Tamper proofing with meter casing\*  
\*optional strip for tamper proofing



4149 85

<b>4149 84</b>	PMX 6000	Dual Source LED meter CI 1 with RS485	6900	1
<b>4149 85</b>	PMX 6000	Dual Source LED meter CI 0.5 with RS485	8146	1

### PMX 7000 multifunction meter

Features

- **RoHS Compliance**
- **Bright LED display to view more than 25 parameters.**
- Displays full range of parameters  
Basic : VLL, VLN, A (Avg. & Phase Wise), F  
Power: W, PF, VA (Avg. & Phase Wise)  
Energy: Wh,
- **Load Hours, Run Hours, Old Wh, Old Load Hours**
- Auto scaling capability in adjustment of Kilo, Mega, Giga.
- **Positive energy accumulation even with CT polarity reversal with reverse lock programmable**
- High Accuracy with class 1 as per IEC 62053-21
- Site selectable CT/PT ratios
- Site selectable CT Secondary 1 A/5 A
- Universal control power supply 80 – 300 V AC/DC, 40-70 Hz
- Password protection for tamper proofing
- **Seamless integration with EMS/SCADA system with RS485 serial channel communication, Industry standard Modbus RTU protocol**
- Provision for Tamper proofing with meter casing\*  
\*optional strip for tamper proofing



4149 90



4149 91

<b>4149 90</b>	PMX 7000	MFM (VAF + W/VA/PF/Wh) LED meter CI 1 with RS485 <sup>^</sup>	6672	1
<b>4149 91</b>	PMX 7300	MFM LED meter CI 1	7954	1
<b>4149 92</b>	PMX 7300	MFM LED meter CI 1 with RS485	9490	1

## PMX Digital Panel Meters

NEW!

Cat.Nos	Model Series	Description	MRP* ₹ / Unit	Pack
---------	--------------	-------------	------------------	------

### PMX 7400

**advance multifunction meter / load manager / demand monitor**

Features

- **RoHS Compliance**
- **Advance multifunction meter with High/Low recording of VLL, VLN, A, Hz, PF, Var with time stamp.**
- **Voltage & Current THD (Total Harmonics Distortion) with Individual harmonics up to 31st order.**
- **K-factor V & A to keep check on the losses due to harmonic load currents & their effects on transformer heating.**
- Load manager with demand monitoring
- **RTC based Demand management**
- **Import/Export/Net monitoring of Wh, VAh, VARh Inductive/Capacitive, Load hours**
- Auto scaling capability in adjustment of Kilo, Mega, Giga.
- **Positive energy accumulation even with CT polarity reversal with reverse lock programmable**
- High Accuracy with class 1 as per IEC 62053-21 & class 0.5s as per IEC 62053-22
- Site selectable CT/PT ratios
- Site selectable CT Secondary 1 A/5 A
- Universal control power supply 80-300 V AC/DC, 40-70 Hz
- Password protection for tamper proofing
- **Seamless integration with EMS/SCADA system with RS485 serial channel communication, Industry standard Modbus RTU protocol.**
- Byte order option – Field Programmable Float/ Little Endian/ Big Endian data formats



4149 96

<b>4149 93</b>	PMX 7400	MFM + THD LED meter CI 1 with RS485	12700	1
<b>4149 94</b>	PMX 7400	MFM + THD LED meter CI 0.5 with RS485	15506	1
<b>4149 95</b>	PMX 7410	MFM + THD + Demand monitoring LED meter CI 1 with RS485	18444	1
<b>4149 96</b>	PMX 7420	MFM + THD with Individual + Harmonics + Demand + Import/Export LED meter CI 1 with RS485	19116	1

Bold Cat.Nos are products normally available with Legrand (India) Stockists. Cat.Nos that are not bold - delivery within 4 - 8 weeks from the date of order. Bold packing quantity is our mandatory packing. Orders to be placed by Legrand (India) Stockist in multiples of the same.



## PMX Digital Panel Meters

NEW!

Cat.Nos	Model Series	Description	MRP* ₹ / Unit	Pack
4149 97	PMX 7420	MFM + THD with Individual + Harmonics + Demand + Import/Export LED meter CI 0.5s with RS485	21792	1

### PMX 8000 advance demand controller

Features

- RoHS Compliance
- Demand controller with 4 relay output
- High memory Data Logger (8MB) for storing multiple parameters.
- Predictive demand with date & time stamping
- Voltage & Current THD (Total Harmonics Distortion) with Individual harmonics up to 31st order.
- K-factor V & A to keep check on the losses due to harmonic load currents & their effects on transformer heating.
- Advance multifunction meter with High/Low recording of VLL, VLN, A, Hz, PF, Var with time stamp.
- RTC based Demand management
- Import/Export/Net monitoring of Wh, VAH, VARh Inductive/Capacitive, Load hours
- Auto scaling capability in adjustment of Kilo, Mega, Giga.
- Positive energy accumulation even with CT polarity reversal with reverse lock programmable
- High Accuracy with class 1 as per IEC 62053-21
- Site selectable CT/PT ratios
- Site selectable CT Secondary 1 A/5 A
- Universal control power supply 80 - 300 V AC/DC, 40-70 Hz
- Password protection for tamper proofing
- Seamless integration with EMS/SCADA system with RS485 serial channel communication, Industry standard Modbus RTU protocol.
- Byte order option - Field Programmable Float/ Little Endian/ Big Endian data formats



4149 98

4149 98	PMX 8000	Demand Controller CI 1 with data logger + Bi directional + THD with Individual Harmonics	42238	1
---------	-------------	---	-------	---

# CTX<sup>3</sup> MINI:

## AN ULTRA-COMPACT SOLUTION UP TO 16 A



With their compact size, CTX<sup>3</sup> MINI are easy to integrate in control panels or distribution boards for switching motors, lighting and heating circuits up to 16 A.



### CTX<sup>3</sup> MINI: MOUNTING ON DIN RAIL OR ON PLATE

- 1 IP 2X screw terminals
- 2 Integrated auxiliary contact (3P only)
- 3 A1 and A2 supply terminal block



Scan to know more about  
the product.



# CTX<sup>3</sup> RTX<sup>3</sup> MPX<sup>3</sup>

UNCOMPROMISING  
PERFORMANCE FOR  
MOTOR PROTECTION  
AND CONTROL



## A COMPLETE RANGE OF DEVICES FOR THE PROTECTION AND CONTROL OF MOTORS

### CTX<sup>3</sup> CONTACTORS AND RTX<sup>3</sup> THERMAL RELAYS UP TO 800 A

- Compact size
- High mechanical and electrical endurance for maximum reliability
- Lowest watt loss
- 3-Pole and 4-pole contactors
- Screw terminals
- Complete range of auxiliaries and accessories

### MPX<sup>3</sup> MOTOR PROTECTION CIRCUIT BREAKERS UP TO 100 A

- High breaking capacity and type 2 coordination for an optimum service level
- Trip class 10
- Sensitive to phase loss
- Compact size
- Can be fixed on 35 mm DIN rail or using screws
- Easy combination with CTX<sup>3</sup> 3-pole contactors
- Complete range of control and signalling auxiliaries and accessories

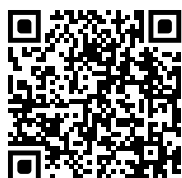

Scan to know more about  
the product.

## Mini contactors CTX<sup>3</sup> 6 to 16 A industrial contactors

Cat.Nos	Max. opt. current AC 3	Max. opt. current AC 1	Control voltage	MRP* ₹ / Unit	Pack
---------	------------------------	------------------------	-----------------	---------------	------

An Ultra Compact Solution Upto 16A (AC3 ) 3P & 4P

For Switching Motors, Lighting and Heating Circuits  
Ultra High Reliability  
Ultra High Endurance  
Ultra Low Wattloss

### Features

Conforms to IEC/EN 60947-4-1  
CE & UL Certified  
Range From 6A to 16A AC3  
Available in 3P & 4P  
Click fit accessories  
Ultra Compact design  
Front and side add on auxiliary contact  
Mechanical Interlock unit  
mini Thermal Overload Relay

### Spare Coils available

RoHS Compliant

### 3 pole mini contactors

With integrated auxiliary contact  
Power terminals: screw terminals

#### 6 A - Integrated auxiliary contact 1 NO

4170 00	6 A	20 A	24 V~	1322	1
4170 01	6 A	20 A	24 V=	1806	1
4170 04	6 A	20 A	110 V~	1322	1
4170 06	6 A	20 A	230 V~	1322	1
4170 09	6 A	20 A	415 V~	1322	1

#### 6 A - Integrated auxiliary contact 1 NC

4170 10	6 A	20 A	24 V~	1322	1
4170 11	6 A	20 A	24 V=	1806	1
4170 14	6 A	20 A	110 V~	1322	1
4170 16	6 A	20 A	230 V~	1322	1
4170 19	6 A	20 A	415 V~	1322	1

#### 9 A - Integrated auxiliary contact 1 NO

4170 20	9 A	20 A	24 V~	1450	1
4170 21	9 A	20 A	24 V=	1920	1
4170 24	9 A	20 A	110 V~	1450	1
4170 26	9 A	20 A	230 V~	1450	1
4170 29	9 A	20 A	415 V~	1450	1

#### 9 A - Integrated auxiliary contact 1 NC

4170 30	9 A	20 A	24 V~	1450	1
4170 31	9 A	20 A	24 V=	1920	1
4170 34	9 A	20 A	110 V~	1450	1
4170 36	9 A	20 A	230 V~	1450	1
4170 39	9 A	20 A	415 V~	1450	1

#### 12 A - Integrated auxiliary contact 1 NO

4170 40	12 A	20 A	24 V~	1570	1
4170 41	12 A	20 A	24 V=	2350	1
4170 44	12 A	20 A	110 V~	1570	1
4170 46	12 A	20 A	230 V~	1570	1
4170 49	12 A	20 A	415 V~	1570	1

#### 12 A - Integrated auxiliary contact 1 NC

4170 50	12 A	20 A	24 V~	1570	1
4170 51	12 A	20 A	24 V=	2350	1
4170 54	12 A	20 A	110 V~	1570	1
4170 56	12 A	20 A	230 V~	1570	1
4170 59	12 A	20 A	415 V~	1570	1

\* MRP - Maximum Retail Price Inclusive of all taxes including GST.

## Mini contactors CTX<sup>3</sup> 6 to 16 A industrial contactors

Cat.Nos	Max. opt. current AC 3	Max. opt. current AC 1	Control voltage	MRP* ₹ / Unit	Pack
---------	------------------------	------------------------	-----------------	---------------	------

#### 16 A - Integrated auxiliary contact 1 NO

4170 60	16 A	20 A	24 V~	1892	1
4170 61	16 A	20 A	24 V=	2722	1
4170 64	16 A	20 A	110 V~	1892	1
4170 66	16 A	20 A	230 V~	1892	1
4170 69	16 A	20 A	415 V~	1892	1

#### 16 A - Integrated auxiliary contact 1 NC

4170 70	16 A	20 A	24 V~	1892	1
4170 71	16 A	20 A	24 V=	2722	1
4170 74	16 A	20 A	110 V~	1892	1
4170 76	16 A	20 A	230 V~	1892	1
4170 79	16 A	20 A	415 V~	1892	1

### 4-pole mini contactors

Without integrated auxiliary contact  
Power terminals: screw terminals

Cat.Nos	Max. opt. current AC 1	Max. opt. current AC 3	Control voltage	MRP* ₹ / Unit	Pack
---------	------------------------	------------------------	-----------------	---------------	------

#### 20 A

4171 40	20 A	16 A	24 V~	1712	1
4171 41	20 A	16 A	24 V=	2178	1
4171 44	20 A	16 A	110 V~	1712	1
4171 46	20 A	16 A	230 V~	1712	1
4171 49	20 A	16 A	415 V~	1730	1

## Mini Thermal Overload Relays RTX<sup>3</sup> mini

for mini contactors

Cat.Nos	Setting Range	MRP* ₹ / Unit	Pack
---------	---------------	---------------	------

### Features

Conforms to IEC/EN 60947-4-1  
CE & UL Certified  
Thermal protection of circuits against overload, long starting times, and phase failure  
Trip Class 10A  
Trip Indication  
Manual/Automatic Reset  
Integrated auxiliary contacts 1 NO & 1 NC

### Thermal overload relays for 3 pole mini contactors

#### Class 10 A - Integrated auxiliary contacts 1 NO + 1 NC

4170 80	0.1~0.16 A	1526	1
4170 81	0.16~0.25 A	1526	1
4170 82	0.25~0.4 A	1526	1
4170 83	0.4~0.63 A	1526	1
4170 84	0.63~1 A	1526	1
4170 85	1~1.6 A	1526	1
4170 86	1.6~2.5 A	1526	1
4170 87	2.5~4 A	1526	1
4170 88	4~6 A	1526	1
4170 89	5~8 A	1526	1
4170 90	6~9 A	1526	1
4170 91	7~10 A	1526	1
4170 92	9~13 A	1526	1
4170 93	12~16 A	1526	1



4170 88

Bold Cat.Nos are products normally available with Legrand (India) Stockists. Cat.Nos that are not bold - delivery within 4 - 8 weeks from the date of order. Bold packing quantity is our mandatory packing. Orders to be placed by Legrand (India) Stockist in multiples of the same.

## Mini Thermal Overload Relays

### RTX<sup>3</sup> mini

Accessories for mini Contactors CTX<sup>3</sup>

Cat.Nos	Setting Range	MRP* ₹ / Unit	Pack
---------	---------------	------------------	------

#### Add on auxiliary blocks for mini contactors

High Thermal current - 10 A  
lth: 10 A

#### Front mounting

4171 50	1 NO + 1 NC	456	10
4171 51	2 NO	456	10
4171 52	2 NC	456	10
4171 53	4 NO	696	10
4171 54	3 NO + 1 NC	696	10
4171 55	2 NO + 2 NC	696	10
4171 56	1 NO + 3 NC	690	10
4171 57	4 NC	690	10

#### Side mounting

4171 58	1 NO	452	10
4171 59	1 NC	452	10

#### Interlock Unit

4171 60	Mechanical interlock for mini contactors	722	5
---------	--	-----	---

#### Spare coils

4171 70	24 V~	796	5
4171 71	24 V=	1080	5
4171 74	110 V~	796	5
4171 76	230 V~	796	5
4171 79	415 V~	796	5

## Power contactors CTX<sup>3</sup>

### Uncompromising Performance for

### Motor Protection & Control

Range from 9A to 800A (AC3) Contactors

#### Features

Conforms to IEC/EN 60947-4-1

CE & UL Certified

Extra Mechanical life upto 15 Million

Extra Electrical life upto 2.5 Million

Extra Low Consumption

Compact size

integrated auxiliary contacts

Front safety Cover to prevent dust entry

Direct Clipping on Din Rail

Both Sides Terminal connection

Click fit accessories

Interlocking kits

Spare Coils

RoHS Compliant

### 3 pole contactors CTX<sup>3</sup>

9 A to 100 A industrial contactors

Cat.Nos	Max. opt. current AC 3	Max. opt. current AC 1	Control voltage	MRP* ₹ / Unit	Pack
---------	------------------------	------------------------	-----------------	------------------	------

#### CTX<sup>3</sup> 22

With integrated auxiliary contacts

Power terminals: screw terminals

9 A - Integrated auxiliary contacts 1 NO + 1 NC

4160 80	9 A	25 A	24 V~	1412	1
4160 81	9 A	25 A	24 V=	2332	1
4160 82	9 A	25 A	48 V~	1412	1
4160 83	9 A	25 A	48 V=	2332	1
4160 84	9 A	25 A	110 V~	1412	1
4160 86	9 A	25 A	230 V~	1412	1
4160 88	9 A	25 A	380 V~	1412	1
4160 89	9 A	25 A	415 V~	1412	1

\* MRP - Maximum Retail Price Inclusive of all taxes including GST.

## 3 pole contactors CTX<sup>3</sup>

9 A to 100 A industrial contactors

Cat.Nos	Max. opt. current AC 3	Max. opt. current AC 1	Control voltage	MRP* ₹ / Unit	Pack
---------	------------------------	------------------------	-----------------	------------------	------

12 A - Integrated auxiliary contacts 1 NO + 1 NC

4160 90	12 A	25 A	24 V~	1614	1
4160 91	12 A	25 A	24 V=	2520	1
4160 92	12 A	25 A	48 V~	1614	1
4160 93	12 A	25 A	48 V=	2520	1
4160 94	12 A	25 A	110 V~	1614	1
4160 96	12 A	25 A	230 V~	1614	1
4160 98	12 A	25 A	380 V~	1614	1
4160 99	12 A	25 A	415 V~	1614	1

18 A - Integrated auxiliary contacts 1 NO + 1 NC

4161 00	18 A	40 A	24 V~	1894	1
4161 01	18 A	40 A	24 V=	3080	1
4161 02	18 A	40 A	48 V~	1894	1
4161 03	18 A	40 A	48 V=	3080	1
4161 04	18 A	40 A	110 V~	1894	1
4161 06	18 A	40 A	230 V~	1894	1
4161 08	18 A	40 A	380 V~	1894	1
4161 09	18 A	40 A	415 V~	1894	1

22 A - Integrated auxiliary contacts 1 NO + 1 NC

4161 10	22 A	40 A	24 V~	2328	1
4161 11	22 A	40 A	24 V=	3956	1
4161 12	22 A	40 A	48 V~	2328	1
4161 13	22 A	40 A	48 V=	3956	1
4161 14	22 A	40 A	110 V~	2328	1
4161 16	22 A	40 A	230 V~	2328	1
4161 18	22 A	40 A	380 V~	2328	1
4161 19	22 A	40 A	415 V~	2328	1

#### CTX<sup>3</sup> 40

With integrated auxiliary contacts

Power terminals: screw terminals

32 A - Integrated auxiliary contacts 2 NO + 2 NC

4161 20	32 A	50 A	24 V~	4880	1
4161 21	32 A	50 A	24 V=	8456	1
4161 22	32 A	50 A	48 V~	4880	1
4161 23	32 A	50 A	48 V=	8456	1
4161 24	32 A	50 A	110 V~	4880	1
4161 26	32 A	50 A	230 V~	4880	1
4161 28	32 A	50 A	380 V~	4880	1
4161 29	32 A	50 A	415 V~	4880	1

40 A - Integrated auxiliary contacts 2 NO + 2 NC

4161 30	40 A	60 A	24 V~	7228	1
4161 31	40 A	60 A	24 V=	10590	1
4161 32	40 A	60 A	48 V~	7228	1
4161 33	40 A	60 A	48 V=	10590	1
4161 34	40 A	60 A	110 V~	7228	1
4161 36	40 A	60 A	230 V~	7228	1
4161 38	40 A	60 A	380 V~	7228	1
4161 39	40 A	60 A	415 V~	7228	1

#### CTX<sup>3</sup> 65

With integrated auxiliary contacts

50 A - Integrated auxiliary contacts 2 NO + 2 NC

Screw terminals

4161 40	50 A	70 A	24 V~	8852	1
4161 41	50 A	70 A	24 V=	12188	1
4161 42	50 A	70 A	48 V~	8852	1
4161 43	50 A	70 A	48 V=	12188	1
4161 44	50 A	70 A	110 V~	8852	1
4161 46	50 A	70 A	230 V~	8852	1
4161 48	50 A	70 A	380 V~	8852	1
4161 49	50 A	70 A	415 V~	8852	1

Bold Cat.Nos are products normally available with Legrand (India) Stockists. Cat.Nos that are not bold - delivery within 4 - 8 weeks from the date of order. Bold packing quantity is our mandatory packing. Orders to be placed by Legrand (India) Stockist in multiples of the same.

### 3 pole contactors CTX<sup>3</sup> 9 A to 100 A industrial contactors

Cat.Nos	Max. opt. current AC 3	Max. opt. current AC 1	Control voltage	MRP* ₹ / Unit	Pack
<b>65 A</b> - Integrated auxiliary contacts 2 NO + 2 NC Screw terminals					
4161 60	65 A	100 A	24 V~	11764	1
4161 61	65 A	100 A	24 V=	13690	1
4161 62	65 A	100 A	48 V~	11764	1
4161 63	65 A	100 A	48 V=	13690	1
4161 64	65 A	100 A	110 V~	11764	1
4161 66	65 A	100 A	230 V~	11764	1
4161 68	65 A	100 A	380 V~	11764	1
4161 69	65 A	100 A	415 V~	11764	1

#### CTX<sup>3</sup> 100

With integrated auxiliary contacts

**75 A** - Integrated auxiliary contacts 2 NO + 2 NC  
Screw terminals

4161 80	75 A	110 A	24 V~	14596	1
4161 81	75 A	110 A	24 V=	16380	1
4161 82	75 A	110 A	48 V~	14596	1
4161 83	75 A	110 A	48 V=	16380	1
4161 84	75 A	110 A	110 V~	14596	1
4161 86	75 A	110 A	230 V~	14596	1
4161 88	75 A	110 A	380 V~	14596	1
4161 89	75 A	110 A	415 V~	14596	1

**85 A** - Integrated auxiliary contacts 2 NO + 2 NC  
Screw terminals

4162 00	85 A	135 A	24 V~	15114	1
4162 01	85 A	135 A	24 V=	17328	1
4162 02	85 A	135 A	48 V~	15114	1
4162 03	85 A	135 A	48 V=	17328	1
4162 04	85 A	135 A	110 V~	15114	1
4162 06	85 A	135 A	230 V~	15142	1
4162 08	85 A	135 A	380 V~	15114	1
4162 09	85 A	135 A	415 V~	15114	1

**100 A** - Integrated auxiliary contacts 2 NO + 2 NC  
Screw terminals

4162 20	100 A	160 A	24 V~	18836	1
4162 21	100 A	160 A	24 V=	21180	1
4162 22	100 A	160 A	48 V~	18836	1
4162 23	100 A	160 A	48 V=	21180	1
4162 24	100 A	160 A	110 V~	18836	1
4162 26	100 A	160 A	230 V~	18836	1
4162 28	100 A	160 A	380 V~	18836	1
4162 29	100 A	160 A	415 V~	18836	1

### 3 pole contactors CTX<sup>3</sup> 130 A to 800 A industrial contactors

#### CTX 150

With integrated auxiliary contacts

**130 A** - Integrated auxiliary contacts 2 NO + 2 NC  
Screw terminals

4162 40	130 A	160 A	24 V~	28010	1
4162 41	130 A	160 A	24 V=	30768	1
4162 42	130 A	160 A	48 V~	28010	1
4162 43	130 A	160 A	48 V=	30768	1
4162 46	130 A	160 A	100-240 V~/=	28010	1
4162 49	130 A	160 A	400-440 V~	28010	1

**150 A** - Integrated auxiliary contacts 2 NO + 2 NC  
Screw terminals

4162 60	150 A	210 A	24 V~	28390	1
4162 61	150 A	210 A	24 V=	30364	1
4162 62	150 A	210 A	48 V~	28390	1
4162 63	150 A	210 A	48 V=	30364	1

\* MRP - Maximum Retail Price Inclusive of all taxes including GST.

### 3 pole contactors CTX<sup>3</sup> 130 A to 800 A industrial contactors

Cat.Nos	Max. opt. current AC 3	Max. opt. current AC 1	Control voltage	MRP* ₹ / Unit	Pack
<b>150 A</b> - Integrated auxiliary contacts 2 NO + 2 NC Screw terminals					
4162 66	150 A	210 A	100-240 V~/=	28440	1
4162 69	150 A	210 A	400-440 ~A	28390	1

#### CTX<sup>3</sup> 225

With integrated auxiliary contacts - Screw terminals

**185 A** - Integrated auxiliary contacts 2 NO + 2 NC

4162 80	185 A	230 A	24 V~/=	35836	1
4162 82	185 A	230 A	48 V~/=	35836	1
4162 86	185 A	230 A	100-240 V~/=	32308	1
4162 89	185 A	230 A	380-450 V~	32308	1

**225 A** - Integrated auxiliary contacts 2 NO + 2 NC

4162 90	225 A	275 A	24 V~/=	36984	1
4162 92	225 A	275 A	48 V~/=	36984	1
4162 96	225 A	275 A	100-240 V~/=	32698	1
4162 99	225 A	275 A	380-450 V~	32346	1

#### CTX<sup>3</sup> 400

With integrated auxiliary contacts - Screw terminals

**265 A** - Integrated auxiliary contacts 2 NO + 2 NC

4163 06	265 A	300 A	100-240 V~/=	42880	1
4163 09	265 A	300 A	380-450 V~	42880	1

**330 A** - Integrated auxiliary contacts 2 NO + 2 NC

4163 16	330 A	350 A	100-240 V~/=	50002	1
4163 19	330 A	350 A	380-450 V~	50002	1

**400 A** - Integrated auxiliary contacts 2 NO + 2 NC

4163 26	400 A	450 A	100-240 V~/=	61178	1
4163 29	400 A	450 A	380-450 V~	61178	1

#### CTX<sup>3</sup> 800

With integrated auxiliary contacts - Screw terminals

**500 A** - Integrated auxiliary contacts 2 NO + 2 NC

4163 36	500 A	580 A	200-240 V~/=	91920	1
4163 39	500 A	580 A	380-450 V~	91920	1

**630 A** - Integrated auxiliary contacts 2 NO + 2 NC

4163 46	630 A	660 A	200-240 V~/=	130894	1
4163 49	630 A	660 A	380-450 V~	130894	1

**800 A** - Integrated auxiliary contacts 2 NO + 2 NC

4163 56	800A	900 A	200-240 V~/=	195196	1
4163 59	800 A	900 A	380-450 V~	195196	1

Bold Cat.Nos are products normally available with Legrand (India) Stockists. Cat.Nos that are not bold - delivery within 4 - 8 weeks from the date of order. Bold packing quantity is our mandatory packing. Orders to be placed by Legrand (India) Stockist in multiples of the same.



4161 86



4162 96



4162 46



4163 56



## Thermal relays RTX<sup>3</sup>

for CTX<sup>3</sup> 3 pole industrial contactors

Cat.Nos	I min. (A)	I max. (A)	MRP* ₹ / Unit	Pack
---------	---------------	---------------	---------------------	------

### Features

Conforms to IEC/EN 60947-4-1

CE & UL Certified

Thermal protection of circuits against overload, long starting times, and phase failure

Trip Class 10A

Trip Indication

Manual/Automatic Reset

### Integrated auxiliary contacts 1 NO & 1 NC

Standard type:

- Overload detecting bimetal is used all for three phases

Differential type:

- Standard type characteristics + phase failure protection

### Thermal overload relays

Class 10A - Integrated auxiliary contacts 1 NO + 1 NC

### RTX<sup>3</sup> 40 - for CTX<sup>3</sup> 22 and 40

Standard type with screw terminals

Cat.Nos	I min. (A)	I max. (A)	MRP* ₹ / Unit	Pack
4166 40	0.1	0.16	1902	1
4166 41	0.16	0.25	1902	1
4166 42	0.25	0.4	1902	1
4166 43	0.4	0.63	1902	1
4166 44	0.63	1	1902	1
4166 45	1	1.6	1902	1
4166 46	1.6	2.5	1902	1
4166 47	2.5	4	1902	1
4166 48	4	6	1902	1
4166 49	5	8	1902	1

### RTX<sup>3</sup> 40 - for CTX<sup>3</sup> 22 and 40

Standard type with screw terminals

Cat.Nos	I min. (A)	I max. (A)	MRP* ₹ / Unit	Pack
4166 50	6	9	1902	1
4166 51	7	10	1902	1
4166 52	9	13	1902	1
4166 53	12	18	1902	1
4166 54	16	22	1992	1
4166 55	18	25	2016	1
4166 56	22	32	2288	1
4166 57	28	40	2462	1



4167 31



4167 65

## Thermal relays RTX<sup>3</sup>

for CTX<sup>3</sup> 3 pole industrial contactors

Cat.Nos	I min. (A)	I max. (A)	MRP* ₹ / Unit	Pack
---------	---------------	---------------	---------------------	------

### RTX<sup>3</sup> 40 - for CTX<sup>3</sup> 22 and 40

Differential type with screw terminals

Cat.Nos	I min. (A)	I max. (A)	MRP* ₹ / Unit	Pack
4166 60	0.1	0.16	2322	1
4166 61	0.16	0.25	2322	1
4166 62	0.25	0.4	2322	1
4166 63	0.4	0.63	2344	1
4166 64	0.63	1	2344	1
4166 65	1	1.6	2344	1
4166 66	1.6	2.5	2344	1
4166 67	2.5	4	2344	1
4166 68	4	6	2354	1
4166 69	5	8	2354	1
4166 70	6	9	2354	1
4166 71	7	10	2354	1
4166 72	9	13	2354	1
4166 73	12	18	2464	1
4166 74	16	22	2464	1
4166 75	18	25	2464	1
4166 76	22	32	3010	1
4166 77	28	40	3010	1

### RTX<sup>3</sup> 65 - for CTX<sup>3</sup> 65

Standard type with screw terminals

Cat.Nos	I min. (A)	I max. (A)	MRP* ₹ / Unit	Pack
4166 83	9	13	3824	1
4166 84	12	18	3824	1
4166 85	16	22	3824	1
4166 86	18	25	3824	1
4166 87	24	36	3824	1
4166 88	28	40	3824	1
4166 89	34	50	3824	1
4166 90	45	65	3824	1

### RTX<sup>3</sup> 100 - for CTX<sup>3</sup> 100

Standard type with screw terminals

Cat.Nos	I min. (A)	I max. (A)	MRP* ₹ / Unit	Pack
4167 23	18	25	6024	1
4167 24	24	36	6196	1
4167 25	28	40	6196	1
4167 26	34	50	6196	1
4167 27	45	65	6196	1
4167 28	54	75	6196	1
4167 29	63	85	6196	1
4167 30	70	95	6196	1
4167 31	80	100	6196	1

### RTX<sup>3</sup> 150 - for CTX<sup>3</sup> 150

Standard type with screw terminals

Cat.Nos	I min. (A)	I max. (A)	MRP* ₹ / Unit	Pack
4167 60	45	65	9112	1
4167 61	54	75	9112	1
4167 62	63	85	9112	1
4167 63	80	105	9112	1
4167 64	95	130	9112	1
4167 65	110	150	9112	1

\* MRP - Maximum Retail Price Inclusive of all taxes including GST.

**Bold Cat.Nos** are products normally available with Legrand (India) Stockists. Cat.Nos that are not bold - delivery within 4 - 8 weeks from the date of order. Bold packing quantity is our mandatory packing. Orders to be placed by Legrand (India) Stockist in multiples of the same.



## Thermal relays RTX<sup>3</sup>

for CTX<sup>3</sup> 3 pole industrial contactors

Cat.Nos	Description	MRP* ₹ / Unit	Pack
---------	-------------	------------------	------

### Separate mounting units

To mount the relays separately from contactors, on DIN rail or panel by fixing screws

4165 91	For RTX <sup>3</sup> 40 up to 32 A	714	1
4165 92	For RTX <sup>3</sup> 40 40 A	714	1
4165 93	For RTX <sup>3</sup> 65 with screw terminals	882	1
4165 94	For RTX <sup>3</sup> 65 with cage terminals	882	1
4165 95	For RTX <sup>3</sup> 100 with screw terminals	1120	1
4165 96	For RTX <sup>3</sup> 100 with cage terminals	1120	1
4165 97	For RTX <sup>3</sup> 150 with screw terminals	1768	1
4165 98	For RTX <sup>3</sup> 150 with cage terminals	1768	1

### Thermal overload relays

Class 10 A - Integrated auxiliary contacts 1 NO + 1 NC

Cat.Nos	I min. (A)	I max. (A)	MRP* ₹ / Unit	Pack
---------	------------	------------	------------------	------

### RTX<sup>3</sup> 225 - for CTX<sup>3</sup> 225

Differential type with screw terminals

4167 80	65	100	12394	1
4167 81	85	125	12394	1
4167 82	100	160	13738	1
4167 83	120	185	13738	1
4167 84	160	240	14268	1



4167 84

### RTX<sup>3</sup> 400 - for CTX<sup>3</sup> 400

Differential type with screw terminals

4167 86	85	125	18190	1
4167 87	100	160	18190	1
4167 88	120	185	18190	1
4167 89	160	240	18190	1
4167 90	200	330	18190	1
4167 91	260	400	18190	1

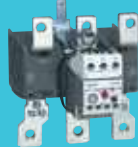

4167 91

### RTX<sup>3</sup> 800 - for CTX<sup>3</sup> 800

Differential type with screw terminals

4167 92	200	300	28290	1
4167 93	260	400	28290	1
4167 94	400	630	28290	1
4167 95	520	800	28290	1



4164 36

## 4-pole contactors CTX<sup>3</sup>

40 A to 900 A industrial contactors and spare coils

Cat.Nos	Max. opt. current AC 1	Max. opt. current AC 3	Control voltage	MRP* ₹ / Unit	Pack
---------	------------------------	------------------------	-----------------	------------------	------

### Contactors CTX<sup>3</sup>

Power terminals: screw terminals

Without integrated auxiliary contact

4164 26	40 A	22 A	230 V~	3066	1
4164 36	60 A	40 A	230 V~	7626	1
4164 46	100 A	65 A	230 V~	13106	1
4164 56	135 A	85 A	230 V~	16120	1



4164 56

\* MRP - Maximum Retail Price Inclusive of all taxes including GST.

## 4-pole contactors CTX<sup>3</sup>

40 A to 900 A industrial contactors and spare coils

Cat.Nos	Max. opt. current AC 1	Max. opt. current AC 3	Control voltage	MRP* ₹ / Unit	Pack
---------	------------------------	------------------------	-----------------	------------------	------

### With integrated auxiliary contacts

Auxiliary contacts: 2 NO + 2 NC

4164 66	165 A	130 A	100-240 V~/=	26708	1
4164 76	250 A	150 A	100-240 V~/=	35882	1
4164 86	330 A	225 A	100-240 V~/=	39936	1
4164 96	420 A	330 A	100-240 V~/=	73840	1
4165 06	500 A	400 A	100-240 V~/=	80796	1
4165 16	750 A	630 A	200-240 V~/=	162418	1
4165 26	900 A	800 A	200-240 V~/=	196352	1



4164 86

### Spare coils for CTX<sup>3</sup> 4P contactors

Cat.Nos	Description	MRP* ₹ / Unit	Pack
---------	-------------	------------------	------

### Control voltage 230 V~

4165 46	For CTX <sup>3</sup> 40 A to 60 A (AC-1)	1502	1
4165 56	For CTX <sup>3</sup> 100 A to 135 A (AC-1)	1786	1
4165 66	For CTX <sup>3</sup> 165 A to 330 A (AC-1)	9388	1
4165 76	For CTX <sup>3</sup> 420 A to 500 A (AC-1)	17524	1
4165 86	For CTX <sup>3</sup> 750 A to 900 A (AC-1)	26288	1

### CTX<sup>3</sup> add-on auxiliary contact blocks

#### Front mounting

For CTX<sup>3</sup> 3P form 9 A to 150 A (AC-3) and CTX<sup>3</sup> 4P from 40 A to 135 A (AC-1) - 2 and 4 pole - lth: 16 A

4168 50	1 NO + 1 NC	468	10
4168 51	2 NO	468	10
4168 52	2 NC	468	10
4168 53	4 NO	746	10
4168 54	3 NO + 1 NC	746	10
4168 55	2 NO + 2 NC	746	10
4168 56	1 NO + 3 NC	746	10
4168 57	4 NC	746	10



4168 50



4168 55

#### Side mounting

2 pole - Mounting on both sides

4168 58	For CTX <sup>3</sup> 3P Form 9 A to 150 A (AC-3) 1 NO + 1 NC - lth: 16 A	826	10
4168 59	For CTX <sup>3</sup> 3P Form 185 A to 800 A (AC-3) and CTX <sup>3</sup> 4P from 165 A to 900 A (AC-1) 1 NO + 1 NC - lth: 16 A	826	10
4168 49	For CTX <sup>3</sup> 4P From 40 A to 135 A (AC-1) 1 NO + 1 NC - lth: 16 A	816	10

Bold Cat.Nos are products normally available with Legrand (India) Stockists. Cat.Nos that are not bold - delivery within 4 - 8 weeks from the date of order. Bold packing quantity is our mandatory packing. Orders to be placed by Legrand (India) Stockist in multiples of the same.

## 4-pole contactors CTX<sup>3</sup>

40 A to 900 A industrial contactors and spare coils



Cat.Nos	Description	MRP* ₹ / Unit	Pack
---------	-------------	------------------	------

### CTX<sup>3</sup> time delay blocks

For CTX<sup>3</sup> 3P from 9 A to 150 A (AC-3)

Time delay: 1 to 30 s

Front mounting

### On delay

4168 70	24-48 V~/=	2190	1
4168 71	110-230 V~	2190	1

### Off delay

4168 72	24-48 V~/=	3006	1
4168 73	110-230 V~	3006	1

## CTX<sup>3</sup>

### capacitor switching units Cat.Nos 4168 74/75/76/77

Capacitor unit is connected to the terminals of the contactor to reduce the high inrush current.

IEC 60947-4-1 AC 6b

Type	Contactor		Maximum operating power (kVA)			Max. Peak current (A)
			220 - 240 V	400 - 480 V	500 - 550 V	
4168 74	CTX <sup>3</sup> 22	9 A	5	9.7	14	560
	CTX <sup>3</sup> 22	12 A	6.7	12.5	18	560
	CTX <sup>3</sup> 22	18 A	8.5	16.7	24	850
	CTX <sup>3</sup> 22	22 A	10	18	26	1250
	CTX <sup>3</sup> 40	32 A	15	25	36	1900
4168 75/76	CTX <sup>3</sup> 40	40 A	20	33.3	48	2160
	CTX <sup>3</sup> 65	50 A	20	40	58	2160
4168 77	CTX <sup>3</sup> 65	65 A	25	45.7	66	3040
	CTX <sup>3</sup> 100	75 A	29.7	54	78	3040
	CTX <sup>3</sup> 100	85 A	35	60	92	3040
Without Capacitor Switching Unit as per IEC 60947-4-1 AC 6b	CTX <sup>3</sup> 100	100 A	37	62	94	3040
	CTX <sup>3</sup> 150	150 A		70		3300
	CTX <sup>3</sup> 225	185 A		84	120	3500
	CTX <sup>3</sup> 225	225 A		115	130	4000
	CTX <sup>3</sup> 400	265 A		125	140	5000
	CTX <sup>3</sup> 400	330 A		139	185	6500
	CTX <sup>3</sup> 400	400 A		185	195	8000
	CTX <sup>3</sup> 800	500 A		220	330	10000
	CTX <sup>3</sup> 800	630 A		291	340	12000
CTX <sup>3</sup> 800	800 A		369	370	14200	

#### Note:

- When the switch is closed capacitor must be discharged before recharged. (Maximum residual voltage at terminals ≤ 50 V)
- To prevent short current, gG type fuse must be 1.5 - 2 times than rated current

## CTX<sup>3</sup> accessories

### CTX<sup>3</sup> capacitor switching units

AC-6b

Operating power from 9.7 kVAR to 62 kVAR (400/440 V)

4168 74	For contactors CTX <sup>3</sup> 3P from 9 to 40 A, upto 33.3 kVA at 440 V / 48 kVA at 525 V	2084	1
---------	---	------	---

\* MRP - Maximum Retail Price Inclusive of all taxes including GST.

## CTX<sup>3</sup> accessories

Cat.Nos	Description	MRP* ₹ / Unit	Pack
---------	-------------	------------------	------

### CTX<sup>3</sup> capacitor switching units

4168 75	For contactors CTX <sup>3</sup> 3P 50 and 65 A with screw terminals upto 45.7 kVA at 440 V / 66 kVA at 525 V	2838	1
4168 76	For contactors CTX <sup>3</sup> 3P 50 and 65 A with cage terminals upto 45.7 kVA at 440 V / 66 kVA at 525 V	3068	1
4168 77	For contactors CTX <sup>3</sup> 3P 75 to 100 A with screw terminals upto 62 kVA at 440 V / 94 kVA at 525 V	3068	1

### CTX<sup>3</sup> interlocking

Component parts for assembling by customer

Horizontal mounting

#### Interlock units

4168 79	Mechanical interlocks for CTX <sup>3</sup> 4P from 40 to 135 A (AC-1)	1252	5
---------	---	------	---

#### Interlock units

4168 80	Mechanical interlocks for CTX <sup>3</sup> 3P from 9 to 150 A Provides 2 NC contacts for use in electrical interlocking	2526	1
4168 87	Mechanical interlocks for CTX <sup>3</sup> 3P from 185 to 400 A and CTX <sup>3</sup> 4P from 165 to 500 A	4380	1

#### Interlock units

4168 88	Mechanical interlocks for CTX <sup>3</sup> 3P from 500 to 800 A	5864	1
4168 89	Mechanical interlocks for CTX <sup>3</sup> 4P from 750 to 900 A	6192	1

#### Wire kits

Used for making reversing between two 3P contactors

4168 82	For CTX <sup>3</sup> 22	1276	5
4168 83	For CTX <sup>3</sup> 40	1726	5
4168 84	For CTX <sup>3</sup> 65	2128	5
4168 85	For CTX <sup>3</sup> 100	3560	5

**Bold Cat.Nos** are products normally available with Legrand (India) Stockists. Cat.Nos that are not bold - delivery within 4 - 8 weeks from the date of order. **Bold packing quantity** is our mandatory packing. Orders to be placed by Legrand (India) Stockist in multiples of the same.

## CTX<sup>3</sup> accessories



4168 91

Cat.Nos	Description	MRP* ₹ / Unit	Pack
---------	-------------	------------------	------

### Boxes for motor starter

For CTX<sup>3</sup> 22 equipped with RTX<sup>3</sup> 40 (0.1 - 22 A)

4168 90	Without pushbuttons	3246	1
4168 91	With pushbuttons	3980	1

### CTX<sup>3</sup> transient voltage suppressor blocks

Absorbs the surge arisen out of the coil of the contactor

4168 95	24-48 V~/=	624	10
4168 96	100-125 V~/=	624	10
4168 97	200-240 V~/=	624	10
4168 98	380-400 V~	624	10



4168 97

### CTX<sup>3</sup> terminals covers

4168 42	For CTX <sup>3</sup> 3P from 185 to 225 A (AC-3)	574	5
4168 43	For CTX <sup>3</sup> 3P from 265 to 400 A (AC-3)	854	5
4168 44	For CTX <sup>3</sup> 3P from 500 to 900 A (AC-3)	1284	5
4168 45	For CTX <sup>3</sup> 4P from 165 to 330 A (AC-1)	716	5
4168 46	For CTX <sup>3</sup> 4P from 420 to 500 A (AC-1)	1084	5
4168 47	For CTX <sup>3</sup> 4P from 750 to 900 A (AC-1)	1828	5



4168 40

### CTX<sup>3</sup> safety front cover

4168 40	For CTX <sup>3</sup> 3P from 9 to 150 A (AC-3) and CTX <sup>3</sup> 4P from 40 to 135 A (AC-1)	36	50
4168 41	For CTX <sup>3</sup> 3P from 85 to 800 A (AC-3) and CTX 4P from 165 to 900 A (AC-1)	144	50

### Distant reset flexible cables for thermal relays

4168 92	400 mm	1072	1
4168 93	500 mm	1164	1
4168 94	600 mm	1182	1

## CTX<sup>3</sup> spare coils

### Spare coils for CTX<sup>3</sup> 3P contactors

For CTX<sup>3</sup> 22

4169 00	24 V~	806	5
4169 02	48 V~	806	5
4169 04	110 V~	806	5
4169 06	230 V~	806	5
4169 08	380 V~	806	5
4169 09	415 V~	806	5

\* MRP - Maximum Retail Price Inclusive of all taxes including GST.

## CTX<sup>3</sup> accessories

Cat.Nos	Description	MRP* ₹ / Unit	Pack
---------	-------------	------------------	------

### For CTX<sup>3</sup> 40

4169 20	24 V~	806	5
4169 21	24 V=	806	5
4169 22	48 V~	806	5
4169 23	48 V=	806	5
4169 24	110 V~	806	5
4169 26	230 V~	806	5
4169 28	380 V~	806	5
4169 29	415 V~	806	5

### For CTX<sup>3</sup> 65

4169 30	24 V~	1242	5
4169 31	24 V=	1242	5
4169 32	48 V~	1242	5
4169 33	48 V=	1242	5
4169 34	110 V~	1242	5
4169 36	230 V~	1242	5
4169 38	380 V~	1242	5
4169 39	415 V~	1242	5

### For CTX<sup>3</sup> 100

4169 40	24 V~	1516	3
4169 41	24 V=	1516	3
4169 42	48 V~	1516	3
4169 43	48 V=	1516	3
4169 44	110 V~	1516	3
4169 46	230 V~	1516	3
4169 48	380 V~	1516	3
4169 49	415 V~	1516	3

### For CTX<sup>3</sup> 150

4169 50	24 V~	5734	1
4169 51	24 V=	5734	1
4169 52	48 V~	5734	1
4169 53	48 V=	5734	1
4169 56	100-240 V~/=	5734	1
4169 59	400-440 V~	5734	1

Bold Cat.Nos are products normally available with Legrand (India) Stockists. Cat.Nos that are not bold - delivery within 4 - 8 weeks from the date of order. Bold packing quantity is our mandatory packing. Orders to be placed by Legrand (India) Stockist in multiples of the same.

## Auxillary Contactor / Control relays CTX<sup>3</sup>



4169 66

Cat.Nos	Description	MRP* ₹ / Unit	Pack
---------	-------------	------------------	------

### For CTX<sup>3</sup> 225

4169 60	24 V~/=	8288	1
4169 62	48 V~/=	8288	1
4169 66	100-240 V~/=	8288	1
4169 69	400-440 V~	8288	1

### For CTX<sup>3</sup> 400

4169 76	100-240 V~/=	12464	1
4169 79	380-450 V~	12464	1

### For CTX<sup>3</sup> 800

4169 86	200-240 V~/=	27138	1
4169 89	380-450 V~	27138	1

## Auxillary Contactor / Control relays CTX<sup>3</sup>

4 pole

Conform to IEC 60 947-1, IEC 60 947-4-1 and IEC 60 947-5-1 for the auxiliary contacts

**CE & UL Certified**

**Ultra High Ith = 10 A**

Ultra Low consumption coil

Click fit accessories

**Spare Coils available**

RoHS Compliant

**CTX<sup>3</sup> control relays**

**4 NO**

4168 00	24 V~	1626	1
4168 01	24 V=	2464	1
4168 02	48 V~	1626	1
4168 03	48 V=	2464	1
4168 04	110 V~	1626	1
4168 06	230 V~	1626	1
4168 09	415 V~	1626	1

### 3 NO + 1 NC

4168 10	24 V~	1626	1
4168 11	24 V=	2464	1
4168 12	48 V~	1626	1
4168 13	48 V=	2464	1
4168 14	110 V~	1626	1
4168 16	230 V~	1626	1
4168 19	415 V~	1626	1

## Accessories for Auxiliary Contactor / Control Relays

Cat.Nos	Description	MRP* ₹ / Unit	Pack
---------	-------------	------------------	------

### 2 NO + 2 NC

4168 20	24 V~	1626	1
4168 21	24 V=	2488	1
4168 22	48 V~	1626	1
4168 23	48 V=	2464	1
4168 24	110 V~	1626	1
4168 26	230 V~	1626	1
4168 29	415 V~	1626	1

### High Thermal current - 10 A

Ith : 10 A

### Front mounting

4171 50	1 NO + 1 NC	456	10
4171 51	2 NO	456	10
4171 52	2 NC	456	10
4171 53	4 NO	696	10
4171 54	3 NO + 1 NC	696	10
4171 55	2 NO + 2 NC	696	10
4171 56	1 NO + 3 NC	690	10
4171 57	4 NC	690	10

### Side mounting

4171 58	1 NO	452	10
4171 59	1 NC	452	10

### Interlock Unit

4171 60	Mechanical interlock	722	5
---------	----------------------	-----	---

### Spare coils

4171 70	24 V~	796	5
4171 71	24 V=	1080	5
4171 74	110 V~	796	5
4171 76	230 V~	796	5
4171 79	415 V~	796	5

**Bold Cat.Nos** are products normally available with Legrand (India) Stockists. Cat.Nos that are not bold - delivery within 4 - 8 weeks from the date of order. Bold packing quantity is our mandatory packing. Orders to be placed by Legrand (India) Stockist in multiples of the same.

\* MRP - Maximum Retail Price Inclusive of all taxes including GST.



4168 10

# CX<sup>3</sup>

Modular Power Contactors for your switching needs



412544



412556

- Manual handle for permanent OFF / ON
- Manual Override for test & Repair
- Confirms to IEC 61095 & IEC 60947 -4-1
- RoHs Compliance



Scan to know more about the product.

## CX<sup>3</sup> contactors

Cat.Nos	Description	MRP* ₹ / Unit	Pack
---------	-------------	------------------	------

### Power contactors CX<sup>3</sup>

Conform to IEC/EN 61095  
Space for power supply busbar on top (up to 25 A)

4125 44	25 A 2 NO contactor	2382	1
4125 45	40 A 2 NO contactor	4070	1
4125 47	63 A 2 NO contactor	4736	1
4125 48	63 A 2 NC contactor	4736	1
4125 49	40 A 3 NO contactor	6806	1
4125 50	63 A 3 NO contactor	7696	1
4125 51	25 A 4 NO contactor	2812	1
4125 53	40 A 4 NO contactor	7182	1
4125 56	63 A 4 NO contactor	8504	1
4125 57	63 A 4 NC contactor	8584	1

### Signalling auxiliaries for contactors

Auxiliary changeover switch

4124 29	For 1 module contactors 16 A to 25 A	3596	1
4124 30	For 2 module contactors 25 A	3608	1
4124 31	For 40 and 63 A contactors	4736	1

\* MRP - Maximum Retail Price Inclusive of all taxes including GST.



4173 08

## MPCBs MPX<sup>3</sup>

Cat.Nos	Rated 3Ph Motor	Magnetic release operating current (A)	MRP* ₹ / Unit	Pack
---------	-----------------	--	------------------	------

motor protection circuit breakers from 0.16 A to 100 A upto 45 KW

Maximum efficiency in a compact unit

Conform to IEC 60947-1, IEC 60947-2, IEC 60947-4

Adjustable thermal release

Magnetic release 13 le max

High breaking capacity

toggle handle

Fixing on rail or by screw

Wide range of accessories

Undervoltage Release

Shunt Release

Auxiliary Contacts

IP 65 Enclosure

Thermal magnetic MPCBs

Adjustable thermal release Magnetic release 13 le max.

### MPX<sup>3</sup> 32S - 3P

Standard breaking capacity with toggle handle

Fixing on rail

415 V breaking capacity Icu (kA) - 100

Cat.Nos	Rated 3Ph Motor (KW)	Thermal release adj. range (A)	Magnetic release operating current (A)	MRP* ₹ / Unit	Pack
---------	----------------------	--------------------------------	--	------------------	------

4173 00	0.02	0.1 to 0.16	2.1	3756	1
4173 01	0.06	0.16 to 0.25	3.3	3756	1
4173 02	0.09	0.25 to 0.4	5.2	3756	1
4173 03	0.12	0.4 to 0.63	8.2	4364	1
4173 04	0.18 / 0.25	0.63 to 1	13	4364	1
4173 05	0.37 / 0.55	1 to 1.6	20.8	4394	1
4173 06	0.75	1.6 to 2.5	32.5	4476	1
4173 07	1.5	2.5 to 4	52	4544	1
4173 08	2.2	4 to 6	78	4566	1
4173 09	3	5 to 8	104	4566	1

415 V breaking capacity Icu (kA) - 50

4173 10	4	6 to 10	130	4566	1
4173 11	5.5	9 to 13	169	4614	1

415 V breaking capacity Icu (kA) - 20

4173 12	7.5	11 to 17	221	5424	1
---------	-----	----------	-----	------	---

415 V breaking capacity Icu (kA) - 15

4173 13	7.5	14 to 22	286	5756	1
4173 14	11	18 to 26	338	6196	1
4173 15	15	22 to 32	416	10296	1

Bold Cat.Nos are products normally available with Legrand (India) Stockists. Cat.Nos that are not bold - delivery within 4 - 8 weeks from the date of order. Bold packing quantity is our mandatory packing. Orders to be placed by Legrand (India) Stockist in multiples of the same.



## MPCBs MPX<sup>3</sup>

Cat.Nos	Description	MRP* ₹ / Unit	Pack
---------	-------------	---------------------	------

### MPX<sup>3</sup> 32H - 3P

High breaking capacity with rotary handle  
415 V breaking capacity Icu (kA) - 100

4173 20	0.02	0.1 to 0.16	2.1	4636	1
4173 21	0.06	0.16 to 0.25	3.3	4636	1
4173 22	0.09	0.25 to 0.4	5.2	4636	1
4173 23	0.12	0.4 to 0.63	8.2	5082	1
4173 24	0.18 / 0.25	0.63 to 1	13	5082	1
4173 25	0.37/ 0.55	1 to 1.6	20.8	5082	1
4173 26	0.75	1.6 to 2.5	32.5	5082	1
4173 27	1.5	2.5 to 4	52	5240	1
4173 28	2.2	4 to 6	78	5262	1
4173 29	3	5 to 8	104	5688	1
4173 30	4	6 to 10	130	5740	1
4173 31	5.5	9 to 13	169	6306	1

415 V breaking capacity Icu (kA) - 50

4173 32	7.5	11 to 17	221	6750	1
4173 33	7.5	14 to 22	286	7896	1
4173 34	11	18 to 26	338	7970	1
4173 35	15	22 to 32	416	12370	1

### MPX<sup>3</sup> 63H - 3P

High breaking capacity with rotary handle  
Fixing on rail or by screw  
415 V breaking capacity Icu (kA) - 100

4173 60	4	6 to 10	130	12010	1
4173 61	5.5	9 to 13	169	12010	1

415 V breaking capacity Icu (kA) - 50

4173 62	7.5	11 to 17	221	12010	1
4173 63	7.5	14 to 22	286	13612	1
4173 64	11	18 to 26	338	13612	1
4173 65	15	22 to 32	416	13612	1
4173 66	18.5	28 to 40	520	15214	1
4173 67	22	34 to 50	650	18686	1
4173 68	30	45 to 63	819	19936	1

### MPX<sup>3</sup> 100H - 3P

High breaking capacity with rotary handle  
Fixing on rail or by screw  
415 V breaking capacity Icu (kA) - 100

4173 70	7.5	11 to 17	221	16600	1
4173 71	7.5	14 to 22	286	16600	1
4173 72	11	18 to 26	338	16600	1



4173 68

## MPCBs MPX<sup>3</sup>

Cat.Nos	Description	MRP* ₹ / Unit	Pack
---------	-------------	---------------------	------

Used to connect MPX<sup>3</sup> directly with the contactor

4173 73	15	22 to 32	416	16600	1
4173 74	18.5	28 to 40	520	16600	1
4173 75	22	34 to 50	650	19728	1
4173 76	30	45 to 63	819	20684	1

415 V breaking capacity Icu (kA) - 75

4173 77	37	55 to 75	975	22238	1
4173 78	45	70 to 90	1170	22238	1
4173 79	45	80 to 100	1300	22238	1



4173 79

### Magnetic only MPCBs

Without thermal release  
Magnetic release 13 x Ie max.

### MPX<sup>3</sup> 32MA - 3P

High breaking capacity with rotary handle  
Fixing on rail   
415 V breaking capacity Icu (kA) - 100

4173 40	0.02	2.1	4248	1
4173 41	0.06	3.3	4248	1
4173 42	0.09	5.2	4248	1
4173 43	0.12	8.2	4730	1
4173 44	0.18 / 0.25	13	4730	1
4173 45	0.37 / 0.55	20.8	4730	1
4173 46	0.75	32.5	4730	1
4173 47	1.5	52	4788	1
4173 48	2.2	78	4788	1
4173 49	3	104	4788	1
4173 50	4	130	5048	1
4173 51	5.5	169	5362	1

415 V breaking capacity Icu (kA) - 50

4173 52	7.5	221	6906	1
4173 53	7.5	286	6906	1
4173 54	11	338	6906	1
4173 55	15	416	11422	1



4173 48

## MPCBs MPX<sup>3</sup> accessories

Cat.Nos	Description	MRP* ₹ / Unit	Pack
---------	-------------	---------------------	------

### Auxiliary contacts

2 pole

### Side mounting

Mounting on the left side of MPCBs  
Two auxiliary contacts per MPCB

4174 00	1 NO + 1 NC	908	5
4174 01	2 NO	908	5
4174 02	2 NC	908	5



4174 00

### Front mounting

One auxiliary contact per MPCB

4174 03	1 NO + 1 NC	938	5
4174 04	2 NO	938	5
4174 05	2 NC	938	5

\* MRP - Maximum Retail Price Inclusive of all taxes including GST.

Bold Cat.Nos are products normally available with Legrand (India) Stockists. Cat.Nos that are not bold - delivery within 4 - 8 weeks from the date of order. Bold packing quantity is our mandatory packing. Orders to be placed by Legrand (India) Stockist in multiples of the same.

## MPCBs MPX<sup>3</sup> accessories

Cat.Nos	Description	MRP* ₹ / Unit	Pack
---------	-------------	---------------------	------

### Alarm contacts

1 NO + 1 NC

#### Any trip alarm contact

Operates in case of trip

Mounting on the left side of MPCBs

Set alarm contact first in case of using auxiliary contact together (MPX<sup>3</sup> 63H can not accept auxiliary contact and alarm contact together)

4174 06	For MPX <sup>3</sup> 32	1466	1
4174 08	For MPX <sup>3</sup> 63 and 100	1466	1

### Magnetic trip alarm contact

Operates in case of instantaneous trip

Mounting on the left side of MPCBs

Set alarm contact first in case of using auxiliary contact together

4174 07	1 NO + 1 NC	1466	1
---------	-------------	------	---

### Shunt release

Mounting on the right side of MPCBs

One release per MPCB

4174 10	24 V~ 50 Hz / 28 V~ 60 Hz	2332	1
4174 11	110 V~ 50 Hz / 120 V~ 60 Hz	2332	1
4174 12	220-230 V~ 50 Hz / 240-260 V~ 60 Hz	2332	1
4174 13	380-400 V~ 50 Hz / 440-460 V~ 60 Hz	2332	1

### Undervoltage release

Mounting on the right side of MPCBs

One release per MPCB

#### Without auxiliary contact

4174 20	24 V~ 50 Hz / 28 V~ 60 Hz	2332	1
4174 21	110 V~ 50 Hz / 120 V~ 60 Hz	2332	1
4174 22	220-230 V~ 50 Hz / 240-260 V~ 60 Hz	2332	1



4174 12



4174 22

## MPCBs MPX<sup>3</sup> accessories

Cat.Nos	Description	MRP* ₹ / Unit	Pack
---------	-------------	---------------------	------

4174 23	380-400 V~ 50 Hz / 440-460 V~ 60 Hz	2332	1
---------	--	------	---

### With 2 NO auxiliary contacts

Can not attach to MPX<sup>3</sup> 32S

4174 30	24 V~ 50 Hz / 28 V~ 60 Hz	3108	1
4174 31	110 V~ 50 Hz / 120 V~ 60 Hz	3108	1
4174 32	220-230 V~ 50 Hz / 240-260 V~ 60 Hz	3108	1
4174 33	380-400 V~ 50 Hz / 440-460 V~ 60 Hz	3108	1

### Dial Cover

Sealable cover to protect the set value from the operation that is not intended

#### Without auxiliary contact

4174 79	For all types of MPX <sup>3</sup>	102	50
---------	-----------------------------------	-----	----

### Direct adaptor and mounting unit

For mounting CTX<sup>3</sup> contactors under MPX<sup>3</sup> MPCBs

#### Direct adaptators

Used to connect MPX<sup>3</sup> directly with the contactor

4174 40	For MPX <sup>3</sup> 32S with CTX <sup>3</sup> mini AC	544	2
4174 41	For MPX <sup>3</sup> 32S with CTX <sup>3</sup> mini DC	544	2
4174 42	For MPX <sup>3</sup> 32H/32MA with CTX <sup>3</sup> mini AC	544	2
4174 43	For MPX <sup>3</sup> 32H/32MA with CTX <sup>3</sup> mini DC	544	2
4174 48	For MPX <sup>3</sup> 32S with CTX <sup>3</sup> 22 AC	652	2

### MPCBs MPX<sup>3</sup> accessories

Cat.Nos	Description	MRP* ₹ / Unit	Pack
4174 49	For MPX <sup>3</sup> 32S with CTX <sup>3</sup> 22 DC	652	2
4174 50	For MPX <sup>3</sup> 32H/32MA with CTX <sup>3</sup> 22 AC	652	2

#### Direct adaptators

Used to connect MPX<sup>3</sup> directly with the contactor

4174 51	For MPX <sup>3</sup> 32H/32MA with CTX <sup>3</sup> 22 DC	652	2
4174 52	For MPX <sup>3</sup> 32S with CTX <sup>3</sup> 40 AC	792	2
4174 53	For MPX <sup>3</sup> 32S with CTX <sup>3</sup> 40 DC	792	2
4174 54	For MPX <sup>3</sup> 32H/32MA with CTX <sup>3</sup> 40 AC	792	2
4174 55	For MPX <sup>3</sup> 32H/32MA with CTX <sup>3</sup> 40 DC	792	2
4174 56	For MPX <sup>3</sup> 63H with CTX <sup>3</sup> 65 AC with cage type terminals	952	2
4174 57	For MPX <sup>3</sup> 63H with CTX <sup>3</sup> 65 DC with cage type terminals	952	2
4174 58	For MPX <sup>3</sup> 100H with CTX <sup>3</sup> 100 AC with cage type terminals	952	1
4174 59	For MPX <sup>3</sup> 100H with CTX <sup>3</sup> 100 DC with cage type terminals	952	1

#### Mounting unit

This device is used for joining together MPX<sup>3</sup> MCPBs and CTX<sup>3</sup> contactors

4174 60	For MPX <sup>3</sup> 32S/32H/32MA	736	2
---------	-----------------------------------	-----	---

### MPCBs MPX<sup>3</sup> accessories

Cat.Nos	Description	MRP* ₹ / Unit	Pack
4174 61	For MPX <sup>3</sup> 63H	1356	1
4174 62	For MPX <sup>3</sup> 100H	1634	1

#### Rotary handle

Mounting on panel's door to control the MPX<sup>3</sup>

4174 63	For MPX <sup>3</sup> 32H and 32 MA	1926	1
4174 64	For MPX <sup>3</sup> 63H	1926	1
4174 65	For MPX <sup>3</sup> 100H	2440	1

#### Phase busbar

For parallel connection of MPX<sup>3</sup>

#### For MPX<sup>3</sup> 32S, 32H and 32MA

Rated current 63 A

4174 71	2 devices	762	5
4174 73	3 devices	1906	5
4174 75	4 devices	1906	5
4174 76	5 devices	1906	5
4174 77	Feeder for phase busbar 32 A	532	5

#### For MPX<sup>3</sup> 63H

Rated current 108 A

4174 72	2 devices	1356	5
4174 74	3 devices	2042	5

#### Enclosures for MPX<sup>3</sup> 32H and 32MA

IP 65 enclosure to use in dusty areas as well as in presence of corrosive gas or liquid

4174 80	Yellow/red with rotary handle	1570	5
4174 81	With black rotary handle	2042	5



4174 61



4174 63



4174 73

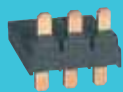

4174 56



4174 81

# Alpx<sup>3</sup>

SELF-HEALING  
ENERGY EFFICIENT  
CAPACITORS



## KEY FEATURES

ROBUST PERFORMANCE EVEN STANDARD DUTY CAN BE USED IN 10% THDI

- Better heat dissipation
- Ease of installation
- Premium quality
- Compact design
- Low energy loss
- Built-in terminal connectors
- Self-healing technology for longer life

## APPLICATION BENEFITS



REDUCE  
ELECTRICITY  
BILLS



INCREASE  
SYSTEM  
CAPACITY



IMPROVE  
VOLTAGE



REDUCE  
OVERALL SYSTEM  
LOSSES



Scan to know more about  
the product.

## Alpican™ gas filled capacitors

Cat.Nos	Description	MRP* ₹ / Unit	Pack
<b>Heavy duty gas filled capacitor 440 V, 3 phase, 50 Hz</b>			
4151 24	5.2 kVAr	3152	1
4151 25	7.3 kVAr	4382	1
4151 26	8.8 kVAr	5182	1
4151 27	10.5 kVAr	6308	1
4151 28	12.6 kVAr	7418	1
4151 29	16.8 kVAr	10404	1
4151 30	21 kVAr	12368	1
4151 31	25.2 kVAr	14700	1



4151 29

**NEW!**

**Alpx<sup>3</sup>**  
 Confirms to IS13340-1&2, IEC60831-1&2  
 ISI Mark  
 Compact Design  
 Self healing metallized polypropylene film  
 Over pressure device for disconnection  
 Low energy losses  
 Resistance to high temperature  
 Resin filled

Can be used in system with <= 10% THDI  
**Standard duty can-type 440 V**

5150 00	1 kVAr Resin std duty 440 V	294	1
5150 01	2 kVAr Resin std duty 440 V	618	1
5150 02	3 kVAr Resin std duty 440 V	886	1
5150 03	4 kVAr Resin std duty 440 V	1238	1
5150 04	5 kVAr Resin std duty 440 V	1452	1
5150 05	7.5 kVAr Resin std duty 440 V	2136	1
5150 06	10 kVAr Resin std duty 440 V	2852	1
5150 07	12.5 kVAr Resin std duty 440 V	3564	1
5150 08	15 kVAr Resin std duty 440 V	4276	1
5150 09	20 kVAr Resin std duty 440 V	5596	1
5150 10	25 kVAr Resin std duty 440 V	7064	1
5150 11	30 kVAr Resin std duty 440 V	8510	1



5150 04



5150 06

### Standard duty can-type 480 V

5150 24	4.2 kVAr Resin 480 V	2186	1
5150 25	6.9 kVAr Resin 480 V	3522	1
5150 26	8.7 kVAr Resin 480 V	4464	1
5150 27	10.4 kVAr Resin 480 V	5366	1
5150 28	14 kVAr Resin 480 V	7148	1
5150 29	17.4 kVAr Resin 480 V	8458	1
5150 30	20.8 kVAr Resin 480 V	10056	1

### Standard duty can-type 525 V

5150 31	5 kVAr Resin 525 V	2598	1
5150 32	8.3 kVAr Resin 525 V	4458	1
5150 33	10.4 kVAr Resin 525 V	5372	1
5150 34	12.5 kVAr Resin 525 V	6600	1
5150 35	16.7 kVAr Resin 525 V	8332	1
5150 36	20.8 kVAr Resin 525 V	10658	1
5150 37	25 kVAr Resin 525 V	12474	1

\* MRP - Maximum Retail Price Inclusive of all taxes including GST.  
 Red Cat.Nos - new products

## Alpx<sup>3</sup> Resin filled capacitors

Cat.Nos	Description	MRP* ₹ / Unit	Pack
<b>Standard duty box-type 440 V</b>			
5150 40	1 kVAr Std box Capacitor 440 V	400	1
5150 41	2 kVAr Std box Capacitor 440 V	796	1
5150 42	3 kVAr Std box Capacitor 440 V	1196	1
5150 43	4 kVAr Std box Capacitor 440 V	1598	1
5150 44	5 kVAr Std box Capacitor 440 V	1966	1
5150 45	7.5 kVAr Std box Capacitor 440 V	2898	1
5150 46	8.33 kVAr Std box Capacitor 440 V	3264	1
5150 47	10 kVAr Std box Capacitor 440 V	3860	1
5150 48	12.5 kVAr Std box Capacitor 440 V	4828	1
5150 49	15 kVAr Std box Capacitor 440 V	5794	1
5150 50	20 kVAr Std box Capacitor 440 V	7580	1
5150 51	25 kVAr Std box Capacitor 440 V	9474	1
5150 52	50 kVAr Std box Capacitor 440 V	19670	1

**NEW!**



5150 47

Can be used in system with <= 15% THDI  
**Heavy duty can-type 440 V**

5150 12	1 kVAr Resin heavy duty 440 V	564	1
5150 13	2 kVAr Resin heavy duty 440 V	1180	1
5150 14	3 kVAr Resin heavy duty 440 V	1690	1
5150 15	4 kVAr Resin heavy duty 440 V	2346	1
5150 16	5 kVAr Resin heavy duty 440 V	2534	1
5150 17	7.5 kVAr Resin heavy duty 440 V	3802	1
5150 18	10 kVAr Resin heavy duty 440 V	4976	1
5150 19	12.5 kVAr Resin heavy duty 440 V	6222	1
5150 20	15 kVAr Resin heavy duty 440 V	7468	1
5150 21	20 kVAr Resin heavy duty 440 V	9584	1
5150 22	25 kVAr Resin heavy duty 440 V	11984	1
5150 23	30 kVAr Resin heavy duty 440 V	14444	1



5150 23

### Heavy duty can-type 440 V

5150 53	5 kVAr HD box capacitor 440 V	3106	1
5150 54	7.5 kVAr HD box capacitor 440 V	4534	1
5150 55	8.33 kVAr HD box capacitor 440 V	5020	1
5150 56	10 kVAr HD box capacitor 440 V	6042	1
5150 57	12.5 kVAr HD box capacitor 440 V	7556	1
5150 58	15 kVAr HD box capacitor 440 V	9068	1
5150 59	20 kVAr HD box capacitor 440 V	11506	1
5150 60	25 kVAr HD box capacitor 440 V	14386	1
5150 61	50 kVAr HD box capacitor 440 V	28768	1

Bold Cat.Nos are products normally available with Legrand (India) Stockists.  
 Cat.Nos that are not bold - delivery within 4 - 8 weeks from the date of order.  
 Bold packing quantity is our mandatory packing. Orders to be placed by Legrand (India) Stockist in multiples of the same.



## Reactors

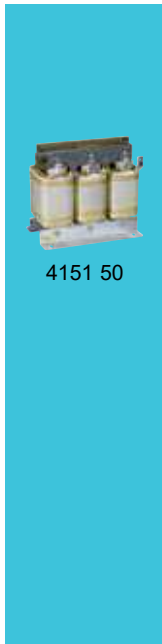

Cat.Nos	Description	MRP* ₹ / Unit	Pack
---------	-------------	------------------	------

### Reactors 7 % duty

4151 48	Reactor 10 kVAr	16138	1
4151 49	Reactor 12.5 kVAr	21130	1
4151 50	Reactor 25 kVAr	26902	1
4151 51	Reactor 50 kVAr	43756	1
4151 52	Reactor 100 kVAr	87640	1

### Reactors 14 % duty

4151 53	Reactor 12.5 kVAr	28516	1
4151 54	Reactor 25 kVAr	47526	1
4151 55	Reactor 50 kVAr	62836	1

### Power factor controller Eco

4151 95	4 step controller	18996	1
4151 96	6 step controller	17224	1
4151 97	8 step controller	19322	1
4151 98	12 step controller	22968	1

\* MRP - Maximum Retail Price Inclusive of all taxes including GST.  
Red Cat.Nos - new products

## Warranty

- The Company, at its discretion, will replace products if they have any manufacturing defect within 1 years for capacitor, Reactor & APFC controller.
- The above guarantee is applicable when the products are selected taken into consideration all the technical characteristics of the product published in our catalogue.
- The guarantee is only applicable when the products are installed as per the Company's instructions and not tampered in any manner.
- The guarantee states the Company's entire liability. It does not extend to cover consequential loss or damage or installation costs arising from defective products.

## Alpx3 range of capacitor - Selection Chart

### DETERMINING THE CAPACITOR BANK TYPE ACCORDING TO THE LEVEL OF HARMONICS

For supplies with a high level of harmonic pollution, Legrand recommends capacitor banks with detuned reactors.

The detuned reactor performs a threefold role:



- Increasing the capacitor impedance in relation to the harmonic currents
- Shifting the parallel resonance frequency (Fr.p) of the source and capacitor to below the main

frequencies of the harmonic currents that are causing interference.

Tuning frequency (Hz)	Blocking factor (P%)	Tuning number (n)
189	7	3.78
135	14	2.7

- Helping to reduce harmonic levels in the supply.

The table opposite can be used to select the capacitor bank type according to the degree of harmonic pollution, by measuring the percentage of THDi and THDu or by estimating the percentage total power of SH/ST non-linear loads.

Measurements		Estimates	Type of capacitor to be used	Reactor to be used
THDu %	THDi %	SH/ST %		
≤ 3	≤ 10	≤ 15	Standard Duty	-
≤ 4	≤ 15	≤ 25	Heavy Duty	-
≤ 6	≤ 30	≤ 35	Standard Duty	7% Reactor *14% Reactor if high level of 3rd order harmonics
≤ 8	≤ 40	≤ 50	Heavy Duty	7% Reactor

SH (kVA) is the weighted total power of the harmonic generators present at the transformer secondary.

ST (kVA) is the power rating of the HV/LV transformer.

THDi = Total Harmonic Distortion (THD) is the ratio of the rms value of the harmonic currents In of the order n to the rms value of the fundamental.

THDu = Voltage Distortion (THDu) is caused mainly by the high level of Current Distortion (THDi) and the level of THDu is dependent on the source impedance.

\* for example if -

- Ih5 > 0.2x145
- Ih3 : 3rd order harmonic currents
- Ih5 : 5th order harmonic currents

Note: These statements are based on our knowledge of typical application. We clearly point out that these statements cannot be regarded as binding statements about the suitability of our products for a particular customer application. It is necessary that the customer should check and decide whether the product is suitable for use in a particular application.

# SURGE PROTECTIVE DEVICES

SOLUTIONS FOR ALL INSTALLATIONS AND RISK LEVELS



Clear, easily identifiable marking for easier maintenance, design in line with other Legrand modular equipment, well thought features: the new SPDs integrate perfectly in the modular rows of Legrand distribution boards and protects sensitive equipment.

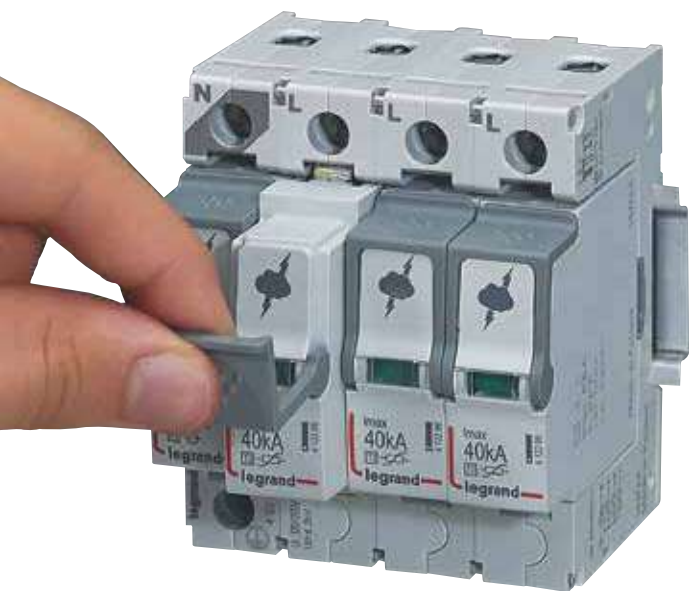

Easier to handle: the plug-in modules are easy to replace thanks to the extraction handles.

Status indicator and remote monitoring of information

Design and marking

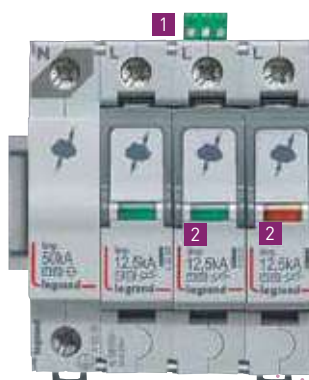

- 1 Fault signal contact
- 2 Status indicator

- 3 Dedicated marking for easier identification and maintenance of the SPDs.



Scan to know more about the product.

# DX<sup>3</sup>

## PERFECT CONTROL OF YOUR INSTALLATION

The DX<sup>3</sup> range  
has a selection  
of electrical  
auxiliaries

**for monitoring  
and controlling  
circuits remotely**

Auxiliary contacts and fault signal  
contacts, shunt trips, undervoltage  
releases, motorised controls and  
automatic reclosers



### Power overvoltage protection (POP)

Protects your system from serious  
damages caused by Overvoltages

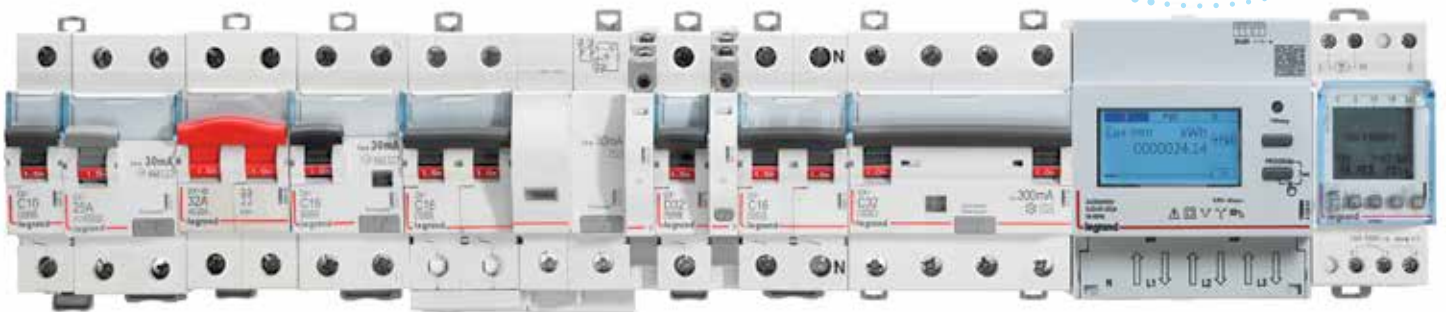

Scan to know more about  
the product.



Marking of auxiliaries (characteristics, connection, mounting)

The fault signal contacts have a test button

The colour code of the indicators on the signalling auxiliaries is the same as that of the remote indicators

DX<sup>3</sup> circuit breakers take up to 3 auxiliaries including one control auxiliary



### OPTIMISED SPACE IN THE DISTRIBUTION BOARD

Legrand motorised controls are the most compact on the market: 1 module wide. They save a great deal of space inside the distribution board.

DX<sup>3</sup> motorised controls can be used with 1 module per pole devices (circuit breakers, RCBOs and RCCBs) just as easily as auxiliaries.



## DX<sup>3</sup> AC MCBs

Cat.Nos	Nominal Rating	Number of 17.5 mm modules	MRP* ₹ / Unit	Pack
---------	----------------	---------------------------	---------------	------

### MCBs for AC applications till 63 A

10 kA ISI marked as per IS/IEC 60898-1 2002  
 Integrated label holder  
 Sliding bottom clamp  
 Efficient air channels  
 Color coded On/Off indication on dolly  
 Biconnect lower terminals  
 IP 20 protected terminals  
 Sliding shutters  
 Compatible with signal and control Auxiliaries

**DC-80 V per pole - 1 kA**

**C Curve**

**Single pole 240/410 V**

4085 80	0.5	1	570	1/10/120
4085 81	1	1	570	1/10/120
4085 83	2	1	570	1/10/120
4085 84	3	1	570	1/10/120
4085 85	4	1	570	1/10/120
<b>4085 87</b>	6	1	356	1/10/120
<b>4085 90</b>	10	1	356	1/10/120
<b>4085 92</b>	16	1	356	1/10/120
<b>4085 93</b>	20	1	356	1/10/120
<b>4085 94</b>	25	1	356	1/10/120
<b>4085 95</b>	32	1	356	1/10/120
4085 96	40	1	808	1/10/120
4085 97	50	1	808	1/10/120
4085 98	63	1	808	1/10/120



4085 90

### Single pole + Neutral 240 V

4086 02	0.5	2	1496	1/5/60
4086 03	1	2	1496	1/5/60
4086 05	2	2	1496	1/5/60
4086 06	3	2	1496	1/5/60
4086 07	4	2	1496	1/5/60
4086 09	6	2	1068	1/5/60
4086 12	10	2	1068	1/5/60
<b>4086 14</b>	16	2	1068	1/5/60
<b>4086 15</b>	20	2	1068	1/5/60
4086 16	25	2	1068	1/5/60
<b>4086 17</b>	32	2	1068	1/5/60
4086 18	40	2	1728	1/5/60
4086 19	50	2	1728	1/5/60
4086 20	63	2	1728	1/5/60



4086 14

### Double pole 415 V

4086 21	0.5	2	1554	1/40
4086 22	1	2	1554	1/40
4086 24	2	2	1554	1/40
4086 25	3	2	1554	1/40
4086 26	4	2	1554	1/40

\* MRP - Maximum Retail Price Inclusive of all taxes including GST.  
 ♦ For further details on product contact nearest Legrand Sales Office.

## DX<sup>3</sup> AC MCBs

Cat.Nos	Nominal Rating	Number of 17.5 mm modules	MRP* ₹ / Unit	Pack
---------	----------------	---------------------------	---------------	------

<b>4086 28</b>	6	2	1144	1/40
<b>4086 31</b>	10	2	1144	1/40
<b>4086 33</b>	16	2	1144	1/40
<b>4086 34</b>	20	2	1144	1/40
<b>4086 35</b>	25	2	1144	1/40
<b>4086 36</b>	32	2	1144	1/40
4086 37	40	2	1800	1/40
4086 38	50	2	1800	1/40
4086 39	63	2	1800	1/40



4086 37

### Triple pole 415 V

4086 43	0.5	3	2288	1/32
4086 44	1	3	2288	1/32
4086 46	2	3	2288	1/32
4086 47	3	3	2288	1/32
4086 48	4	3	2288	1/32
<b>4086 50</b>	6	3	1836	1/32
<b>4086 53</b>	10	3	1836	1/32
<b>4086 55</b>	16	3	1836	1/32
<b>4086 56</b>	20	3	1836	1/32
<b>4086 57</b>	25	3	1836	1/32
<b>4086 58</b>	32	3	1836	1/32
4086 59	40	3	2786	1/32
4086 60	50	3	2786	1/32
4086 61	63	3	2786	1/32



4086 55

### Triple pole + Neutral 415 V

4086 65	0.5	4	2902	1/32
4086 66	1	4	2902	1/32
4086 68	2	4	2902	1/32
4086 69	3	4	2902	1/32
4086 70	4	4	2902	1/32
4086 72	6	4	2394	1/32
4086 75	10	4	2394	1/32
4086 77	16	4	2394	1/32
4086 78	20	4	2394	1/32
4086 79	25	4	2394	1/32
<b>4086 80</b>	32	4	2394	1/32
<b>4086 81</b>	40	4	3426	1/32
4086 82	50	4	3426	1/32
<b>4086 83</b>	63	4	3426	1/32



4086 77

### Four pole 415 V

4086 84	0.5	4	2864	1/32
4086 85	1	4	2864	1/32
4086 87	2	4	2864	1/32
4086 88	3	4	2864	1/32

Bold Cat.Nos are products normally available with Legrand (India) Stockists.  
 Cat.Nos that are not bold - delivery within 4 - 8 weeks from the date of order.  
 Bold packing quantity is our mandatory packing. Orders to be placed by Legrand (India) Stockist in multiples of the same.



## DX<sup>3</sup> AC MCBs



4086 94

Cat.Nos	Nominal Rating	Number of 17.5 mm modules	MRP* ₹ / Unit	Pack
4086 89	4	4	2864	1/32
4086 91	6	4	2496	1/32
4086 94	10	4	2496	1/32
4086 96	16	4	2496	1/32
4086 97	20	4	2496	1/32
4086 98	25	4	2496	1/32
<b>4086 99</b>	32	4	2496	1/32
<b>4087 00</b>	40	4	3550	1/32
4087 01	50	4	3550	1/32
<b>4087 02</b>	63	4	3550	1/32

## D Curve

### Single pole 240/415 V

4087 06	0.5	1	574	1/10/120
4087 07	1	1	574	1/10/120
4087 09	2	1	574	1/10/120
4087 10	3	1	574	1/10/120
4087 11	4	1	574	1/10/120
<b>4087 12</b>	6	1	486	1/10/120
<b>4087 14</b>	10	1	486	1/10/120
<b>4087 16</b>	16	1	486	1/10/120
<b>4087 17</b>	20	1	486	1/10/120
<b>4087 18</b>	25	1	486	1/10/120
<b>4087 19</b>	32	1	486	1/10/120
4087 20	40	1	874	1/10/120
4087 21	50	1	874	1/10/120
4087 22	63	1	874	1/10/120



4087 19

### Single pole + Neutral 240 V

4087 26	0.5	2	1512	1/5/60
4087 27	1	2	1512	1/5/60
4087 29	2	2	1512	1/5/60
4087 30	3	2	1512	1/5/60
4087 31	4	2	1512	1/5/60

### Double pole 415 V

4087 32	0.5	2	1566	1/40
4087 33	1	2	1566	1/40
4087 35	2	2	1566	1/40
4087 36	3	2	1566	1/40
4087 37	4	2	1566	1/40
<b>4087 38</b>	6	2	1172	1/40
<b>4087 40</b>	10	2	1172	1/40
<b>4087 42</b>	16	2	1172	1/40
<b>4087 43</b>	20	2	1172	1/40
<b>4087 44</b>	25	2	1172	1/40
<b>4087 45</b>	32	2	1172	1/40
4087 46	40	2	1912	1/40



4087 46

\* MRP - Maximum Retail Price Inclusive of all taxes including GST.

♦ For further details on product contact nearest Legrand Sales Office.

## D Curve



4087 52

Cat.Nos	Nominal Rating	Number of 17.5 mm modules	MRP* ₹ / Unit	Pack
4087 47	50	2	1912	1/40
4087 48	63	2	1912	1/40

### Triple pole 415 V

4087 52	0.5	3	2356	1/32
4087 53	1	3	2356	1/32
4087 55	2	3	2356	1/32
4087 56	3	3	2356	1/32
4087 57	4	3	2356	1/32
4087 58	6	3	1894	1/32
4087 60	10	3	1894	1/32
4087 62	16	3	1894	1/32
4087 63	20	3	1894	1/32
4087 64	25	3	1894	1/32
4087 65	32	3	1894	1/32
4087 66	40	3	2924	1/32
4087 67	50	3	2924	1/32
4087 68	63	3	2924	1/32

### Triple pole + Neutral 415 V

4087 72	0.5	4	2874	1/32
4087 73	1	4	2874	1/32
4087 75	2	4	2874	1/32
4087 76	3	4	2874	1/32
4087 77	4	4	2874	1/32

### Four pole 415 V

4087 78	0.5	4	2866	1/32
4087 79	1	4	2866	1/32
4087 81	2	4	2866	1/32
4087 82	3	4	2866	1/32
4087 83	4	4	2866	1/32
4087 84	6	4	2502	1/32
4087 86	10	4	2502	1/32
4087 88	16	4	2502	1/32
4087 89	20	4	2502	1/32
4087 90	25	4	2502	1/32
4087 91	32	4	2502	1/32
4087 92	40	4	3744	1/32
4087 93	50	4	3744	1/32
4087 94	63	4	3744	1/32



4087 90

### Circuit breakers AC applications 80 - 125 A

10 kA as per IEC 60947-2  
Integrated label holder  
Sliding insulating shield  
Color coded contact indication window  
IP 20 protected terminals  
50 sq mm terminals

### \*Single pole 230 V / 400 V

4085 99	80	1.5	3104	1/5/160
---------	----	-----	------	---------

Bold Cat.Nos are products normally available with Legrand (India) Stockists. Cat.Nos that are not bold - delivery within 4 - 8 weeks from the date of order. Bold packing quantity is our mandatory packing. Orders to be placed by Legrand (India) Stockist in multiples of the same.

## DX<sup>3</sup> MCB



4086 00

Cat.Nos	Nominal Rating	Number of 17.5 mm modules	MRP* ₹ / Unit	Pack
4086 00	100	1.5	3446	1/5/161
4086 01	125	1.5	3686	1/5/162



4086 40

### Double pole 230 V / 400 V\*

4086 40	80	3	6846	1/5/60
4086 41	100	3	7298	1/5/60
4086 42	125	3	7946	1/5/60



4086 63

### Triple pole 400 V\*

4086 62	80	4.5	10898	1/9
4086 63	100	4.5	11608	1/9
4086 64	125	4.5	12758	1/9



4087 05

### Four pole 400 V\*

4087 03	80	6	14188	1/9
4087 04	100	6	14782	1/9
4087 05	125	6	16562	1/9

## DX<sup>3</sup> DC MCBs

### Circuit breakers DC applications upto 63 A

6 kA as per IEC 60947-2  
Integrated label holder  
Sliding bottom clamp  
Improved air channels  
Color coded On/Off indication on dolly  
Biconnect lower terminals  
IP 20 protected terminals  
Sliding shutters

#### Single pole 250 V

4087 98	0.5	1	862	1/10/120
4087 99	1	1	862	1/10/120
4088 01	2	1	862	1/10/120
4088 02	3	1	862	1/10/120
4088 03	4	1	862	1/10/120
4088 04	6	1	714	1/10/120
4088 06	10	1	714	1/10/120
4088 08	16	1	714	1/10/120
4088 09	20	1	714	1/10/120
4088 10	25	1	714	1/10/120
4088 11	32	1	714	1/10/120
4088 12	40	1	944	1/10/120
4088 13	50	1	944	1/10/120
4088 14	63	1	944	1/10/120

#### Double pole 250 V

4088 15	0.5	1	1788	1/5/60
4088 16	1	1	1788	1/5/60
4088 18	2	1	1792	1/5/60
4088 19	3	1	1792	1/5/60
4088 20	4	1	1792	1/5/60
4088 21	6	1	1644	1/5/60



4088 12

## DX<sup>3</sup> MCB

Cat.Nos	Nominal Rating	Number of 17.5 mm modules	MRP* ₹ / Unit	Pack
---------	----------------	---------------------------	---------------	------

4088 23	10	1	1644	1/5/60
4088 25	16	1	1644	1/5/60
4088 26	20	1	1644	1/5/60
4088 27	25	1	1644	1/5/60
4088 28	32	1	1644	1/5/60
4088 29	40	1	1940	1/5/60
4088 30	50	1	1940	1/5/60
4088 31	63	1	1940	1/5/60

## DX<sup>3</sup> RDSO DC MCB

### Single pole

4088 32	0.5	1	894	1/10/120
4088 33	1	1	894	1/10/120
4088 34	1.5	1	894	1/10/120
4088 35	1.6	1	894	1/10/120
4088 36	2.5	1	894	1/10/120
4088 37	3	1	648	1/10/120
4088 38	4	1	648	1/10/120
4088 39	5	1	786	1/10/120
4088 40	10	1	786	1/10/120
4088 41	15	1	786	1/10/120
4088 42	20	1	786	1/10/120
4088 43	25	1	786	1/10/120
4088 44	30	1	898	1/10/120
4088 45	35	1	898	1/10/120
4088 46	40	1	988	1/10/120
4088 47	50	1	988	1/10/120
4088 48	60	1	988	1/10/120

## DX<sup>3</sup> isolators

### Isolators for AC applications upto 125 A

ISI marked as per IEC 60947-3  
Integrated label holder  
Ergonomic red color dolly  
Sliding bottom clamp  
Double break mechanism  
Improved air channels  
Color coded On/Off indication on dolly  
Biconnect lower terminals  
IP 20 protected terminals  
Compatible with signal and control Auxiliaries  
Sliding shutters

#### Double pole 240 V

4065 00	32	2	608	1/5/60
<b>4065 01</b>	40	2	670	1/5/60
<b>4065 02</b>	63	2	886	1/5/60
4065 04	100	2	1228	1/5/60
4065 05	125	2	1396	1/5/60

#### Triple pole 415 V

4065 09	32	3	1098	1/40
<b>4065 10</b>	40	3	1176	1/40
<b>4065 11</b>	63	3	1400	1/40



4065 00



4065 10

\* MRP - Maximum Retail Price Inclusive of all taxes including GST.  
♦ For further details on product contact nearest Legrand Sales Office.

Bold Cat.Nos are products normally available with Legrand (India) Stockists. Cat.Nos that are not bold - delivery within 4 - 8 weeks from the date of order. Bold packing quantity is our mandatory packing. Orders to be placed by Legrand (India) Stockist in multiples of the same.

## Isolators for AC applications upto 125 A

Cat.Nos	Nominal Rating	Number of 17.5 mm modules	MRP* ₹ / Unit	Pack
4065 13	100	3	1576	1/40
4065 14	125	3	1818	1/40

### Four pole 415 V

4065 18	32	4	1204	1/32
<b>4065 19</b>	40	4	1494	1/32
<b>4065 20</b>	63	4	1648	1/32
4065 22	100	4	2050	1/32
4065 23	125	4	2260	1/32



4065 20

## DX<sup>3</sup> RCCBs

### RCCBs for AC applications upto 63 A

ISI marked as per IS 12640-1

Integrated label holder

Ergonomic Grey color dolly

Sliding bottom clamp

Compatible with signal and control Auxiliaries

Color coded On/Off indication on dolly

Biconnect lower terminals

IP 20 protected terminals

35 sq mm terminals

Sliding shutters

### Type -AC

Sensitive to residual alternating currents

Use : standard applications

### Double pole 240 V

30 mA

<b>4118 51</b>	25	2	3898	1/5/60
<b>4118 52</b>	40	2	4564	1/5/60
4118 53	63	2	5558	1/5/60



4118 57

100 mA

<b>4118 56</b>	25	2	4278	1/5/60
<b>4118 57</b>	40	2	4968	1/5/60
4118 58	63	2	5898	1/5/60

300 mA

4118 61	25	2	4358	1/5/60
4118 62	40	2	5074	1/5/60
4118 63	63	2	5938	1/5/60

### Four pole 415 V

30 mA

4118 76	25	4	5472	1/32
<b>4118 77</b>	40	4	5402	1/32
<b>4118 78</b>	63	4	6152	1/32



4118 77

100 mA

4118 81	25	4	5676	1/32
<b>4118 82</b>	40	4	5712	1/32
<b>4118 83</b>	63	4	6740	1/32



4118 83

300 mA

4118 86	25	4	5812	1/32
<b>4118 87</b>	40	4	5898	1/32
<b>4118 88</b>	63	4	6740	1/32

## RCCBs for AC applications upto 63 A

Cat.Nos	Nominal Rating	Number of 17.5 mm modules	MRP* ₹ / Unit	Pack
---------	----------------	---------------------------	---------------	------

### Type -S

Delayed trip for discrimination with other residual current devices.

Use : for discrimination with a downstream device

### Double pole 415 V, A-S

300 mA

4118 66	25	2	7518	1/5/60
4118 67	40	2	7892	1/5/60
4118 68	63	2	8082	1/5/60

### Four pole 415 V, A-S

300 mA

4118 91	25	4	8424	1/5/60
4118 92	40	4	8532	1/5/60
4118 93	63	4	8914	1/5/60



4118 93

### Type Hpi

Enhanced immunity to unwanted tripping in environments with disturbances. eg. diesels, computers, printers, etc.

• Detects faults with DC components eg. thyristors, trio etc.

### Double pole 240 V, HPI

30 mA

4118 71	25	2	8308	1/5/60
4118 72	40	2	8724	1/5/60
4118 73	63	2	8976	1/5/60

### Four pole 415 V, HPI

30 mA

4118 96	25	4	9360	1/32
4118 97	40	4	9656	1/32
4118 98	63	4	9906	1/32



4118 97

## DX<sup>3</sup> RCBOs

### RCBOs assembled for AC applications upto 63 A

ISI marked as per IS 12640-2

Integrated label holder

Ergonomic design

Color coded On/Off indication on dolly

Compatible with signal and control Auxiliaries

Front face indication for earth leakage fault

IP 20 protected terminals

35 sq mm terminals

Sliding shutters

### Type -AC

Sensitive to residual alternating currents

Use : standard applications

### Double pole 240 V, AC Type

30 mA

4113 22	6	4	4864	1/32
4113 23	10	4	4816	1/32
<b>4113 24</b>	16	4	4574	1/32
<b>4113 25</b>	25	4	4574	1/32
<b>4113 26</b>	32	4	5056	1/32
<b>4113 27</b>	40	4	5958	1/32
4113 28	63	4	7260	1/32



4113 24

\* MRP - Maximum Retail Price Inclusive of all taxes including GST.

Bold Cat.Nos are products normally available with Legrand (India) Stockists. Cat.Nos that are not bold - delivery within 4 - 8 weeks from the date of order. Bold packing quantity is our mandatory packing. Orders to be placed by Legrand (India) Stockist in multiples of the same.

## RCBOs assembled for AC applications upto 63 A

Cat.Nos	Nominal Rating	Number of 17.5 mm modules	MRP* ₹ / Unit	Pack
---------	----------------	---------------------------	---------------	------

### 100 mA

4113 29	6	4	6060	1/32
4113 30	10	4	6060	1/32
4113 31	16	4	5832	1/32
<b>4113 32</b>	25	4	5724	1/32
<b>4113 33</b>	32	4	5832	1/32
<b>4113 34</b>	40	4	6706	1/32
4113 35	63	4	7764	1/32

### 300 mA

4113 36	16	4	6026	1/32
<b>4113 37</b>	25	4	6026	1/32
<b>4113 38</b>	32	4	6026	1/32
<b>4113 39</b>	40	4	6904	1/32
4113 40	63	4	7906	1/32

### Four pole 415 V, AC Type 30 mA

4113 65	16	7	6570	1/16
4113 66	25	7	6570	1/16
<b>4113 67</b>	32	7	6776	1/16
<b>4113 68</b>	40	7	6752	1/16
<b>4113 69</b>	63	7	7996	1/16

### Four pole 415 V, AC Type 100 mA

4113 70	16	7	7408	1/16
4113 71	25	7	7092	1/16
<b>4113 72</b>	32	7	7166	1/16
<b>4113 73</b>	40	7	7378	1/16
4113 74	63	7	8382	1/16

### Four pole 415 V, AC Type 300 mA

4113 75	16	7	7636	1/16
4113 76	25	7	7372	1/16
<b>4113 77</b>	32	7	7372	1/16
<b>4113 78</b>	40	7	7518	1/16
4113 79	63	7	8528	1/16



4113 79

## RCBOs compact for AC applications upto 32 A, 6 kA

Conforms to IEC 60947  
Integrated label holder

Ergonomic design

Color coded On/Off indication on dolly

Front face indication for earth leakage fault

IP 20 protected terminals

35 sq mm terminals

Sliding shutters

\* MRP - Maximum Retail Price Inclusive of all taxes including GST.

## RCBOs compact for AC applications

Cat.Nos	Description	Number of 17.5 mm modules	MRP* ₹ / Unit	Pack
---------	-------------	---------------------------	---------------	------

### Type -AC

Sensitive to residual alternating currents

Use : standard applications

### Double pole 240 V, AC Type

#### 30 mA

4113 90	6	2	5660	1/32
4113 91	10	2	5660	1/32
<b>4113 92</b>	16	2	5660	1/32
4113 93	20	2	5660	1/32
<b>4113 94</b>	25	2	5660	1/32
<b>4113 95</b>	32	2	5942	1/32



4113 94

#### 300 mA

4113 97	6	2	5832	1/32
4113 98	10	2	5934	1/32
4113 99	16	2	5934	1/32
4114 00	20	2	5934	1/32
4114 01	25	2	5934	1/32
4114 02	32	2	6230	1/32

### Four pole 415 V, AC Type 30 mA

4114 18	10	4	7698	1/16
4114 19	16	4	7698	1/16
4114 20	20	4	7698	1/16
4114 21	25	4	7698	1/16

### Four pole 415 V, AC Type 300 mA

4114 23	10	4	8662	1/16
4114 24	16	4	8662	1/16
4114 25	20	4	8662	1/16
4114 26	25	4	8662	1/16

### Type Hpi

Enhanced immunity to unwanted tripping in environments with disturbances. eg. diesels, computers, printers, etc.

• Detects faults with DC components eg. thyristors, trio etc.

### Double pole 240 V, HPI Type

#### 30 mA

4114 15	25	2	10854	1/32
4114 16	32	2	11472	1/32
4114 17	40	2	13646	1/32

### Type A

Sensitive to residual alternating currents and residual currents with a DC component.

Use : special applications

- if it is possible that the fault currents are not purely sinusoidal (rectifier bridge, etc.)

### Four pole 415 V, A Type

#### 30 mA

4114 28	10	4	8682	1/16
4114 29	16	4	8682	1/16
4114 30	20	4	8682	1/16
4114 31	25	4	8682	1/16

Bold Cat.Nos are products normally available with Legrand (India) Stockists. Cat.Nos that are not bold - delivery within 4 - 8 weeks from the date of order. Bold packing quantity is our mandatory packing. Orders to be placed by Legrand (India) Stockist in multiples of the same.

## RCBOs compact for AC applications

Cat.Nos	Nominal Rating	Number of 17.5 mm modules	MRP* ₹ / Unit	Pack
---------	----------------	---------------------------	---------------	------

### Four pole 415 V, A Type 300 mA

4114 33	10	4	9488	1/16
4114 34	16	4	9488	1/16
4114 35	20	4	9488	1/16
4114 36	25	4	9488	1/16

### DX<sup>3</sup> RCD add on module

#### For 125 A

Conform to IEC 61009-1

AC type : detect AC components faults

Hpi type :detect faults with AC and DC components, increased

Immunity to false tripping

For mounting on the right-hand side of 1.5 module per pole DX<sup>3</sup> MCBs

Easy & fast association mechanism

Terminal cover for locking

70 sq mm terminals

### Double pole 240 V, AC Type 30 mA

4105 68	125 A	4	17632	1
---------	-------	---	-------	---

### 100 mA

4105 69	125 A	4	19880	1
---------	-------	---	-------	---

### 300 mA

4105 71	125 A	4	19880	1
---------	-------	---	-------	---

### Four pole 415 V, AC Type 30 mA

4106 25	125 A	4	27830	1
---------	-------	---	-------	---

### 100 mA

4106 26	125 A	4	31098	1
---------	-------	---	-------	---

### 300 mA

4106 29	125 A	4	31098	1
---------	-------	---	-------	---

### Double pole 240 V, HPI type 30 mA

4105 78	125 A	6	22444	1
---------	-------	---	-------	---

### 100 mA

4105 79	125 A	6	25086	1
---------	-------	---	-------	---

### 300 mA

4105 82	125 A	6	25086	1
---------	-------	---	-------	---

### Four pole 415 V, HPI type 30 mA

4106 38	125 A	6	38470	1
---------	-------	---	-------	---

### 100 mA

4106 39	125 A	6	40718	1
---------	-------	---	-------	---

### 300 mA

4106 42	125 A	6	40718	1
---------	-------	---	-------	---

\* MRP - Maximum Retail Price Inclusive of all taxes including GST.



4105 68



4105 78



4062 50



4062 52



4062 78



4062 82

## DX<sup>3</sup> auxiliaries

Cat.Nos	Description	Number of 17.5 mm modules	MRP* ₹ / Unit	Pack
---------	-------------	---------------------------	---------------	------

### Auxiliaries common for MCBs, Isolators, RCCBs & RCBOs

Easy & fast fixation on site

On site clip on mounting

Clip on fitting on left side

### Signalling auxiliaries

4062 50	Auxiliary changeover switch 6 A	0.5	1146	1
4062 52	Fault signalling changeover switch 6 A	0.5	1344	1
4062 64	Changeover + fault signalling switch	1	2126	1

### Control auxiliaries

4062 76	Shunt release 12 /48 V AC/ DC	1	3014	1
4062 78	Shunt release 110/415 V V AC	1	2988	1
4062 80	Undervoltage release 24/48 V AC/DC	1	2546	1
4062 82	Undervoltage release 230 V AC	1	2546	1

### Control auxiliaries

4062 86	Pop over voltage release	1	3212	1
4062 90	Motor control 24/48 V AC/ DC	1	11808	1
4062 91	Motor control 110/415 V AC	1	11808	1
4062 93	Motor control 24/48 V AC/ DC	2	22230	1
4062 95	Motor control 110/415 V AC	2	20996	1
4062 88	Automatic resetter	2	15680	1
4062 89	Automatic resetter with autotest	2	19432	1

Bold Cat.Nos are products normally available with Legrand (India) Stockists. Cat.Nos that are not bold - delivery within 4 - 8 weeks from the date of order. Bold packing quantity is our mandatory packing. Orders to be placed by Legrand (India) Stockist in multiples of the same.



## DX<sup>3</sup> auxiliaries

Cat.Nos	Description	Number of 17.5 mm modules	MRP* ₹ / Unit	Pack
---------	-------------	---------------------------	---------------	------

### Rotary handle

4063 19	Black rotary handle	-	2404	10
4063 20	Yellow/red rotary handle	-	2680	10

### Support for padlock

4063 03	Support for padlock till 63 A	-	562	10
---------	-------------------------------	---	-----	----

### Sealable screw cover

4063 04	Devices upto 63 A	-	556	10
4063 06	For 80-125 A devices	-	970	10

### 1/2 module spacing unit

4063 07	1/2 module spacing unit	0.5	208	10
---------	-------------------------	-----	-----	----

### 5 mm padlock

4063 13	5 mm Padlock	0.5	476	10
---------	--------------	-----	-----	----

### Manual changover switch

Compact design  
Manual switching operation  
Easy to assemble  
Ergonomic design

#### For 1 mod/pole devices

4063 14	Manual change-over switch for DP	1	2812	5
4063 15	Manual change-over switch for TP	1	3248	5
4063 16	Manual change-over switch for FP	1	3538	5

## DX<sup>3</sup> RCD add on module

### with measurement & metering

Cat.Nos	Nominal Rating	Number of 17.5 mm modules	MRP* ₹ / Unit	Pack
---------	----------------	---------------------------	---------------	------

Conform to IEC 61009-1  
Hpi type: detect faults with AC and DC components, increased  
Immunity to false tripping  
Inbuilt measurement/metering option  
Measurement - V, A, F, PF, kWh, KVA, KVAR, THD  
Metering - V, A, F, kWh  
RS 485 port for remote reading  
Di-electric test button inbuilt  
Ergonomic test button  
Scroll button for easy readings  
RLCD display on front facia  
For mounting on the right-hand side of 1.5 module per pole DX3 MCBs

■ Price available on request.

\* MRP - Maximum Retail Price Inclusive of all taxes including GST.

<sup>1</sup> 1P+N and 3P+N: L-N and N-PE protection modes (common and differential modes), the N pole being protected by encapsulated spark gaps. Also called sometimes 1+1 and 3+1

<sup>2</sup> Replaced mid 2015 by Cat.No 4122 80

## DX<sup>3</sup> RCD add on module

Cat.Nos	Nominal Rating	Number of 17.5 mm modules	MRP* ₹ / Unit	Pack
---------	----------------	---------------------------	---------------	------

Easy & fast association mechanism  
70 sq mm terminals

### Adjustable metering, four pole 415 V

4106 57	63 A	7	19276	1
4106 58	125 A	7	35330	1

### Adjustable measurement

4106 59	125 A	7	38908	1
---------	-------	---	-------	---

## DX<sup>3</sup> time switches

Cat.Nos	Description	No. of Modules	MRP* ₹ / Unit	Pack
---------	-------------	----------------	---------------	------

For switching an electric circuit (lighting, heating) ON or OFF at selected times during a pre-programmed time period.

### Alpharex3 Digital Time switches

#### Weekly time switch

Time-saving programming by selection of daily blocks, daily blocks individually adjustable or selection from preset blocks Mo-Fr and Mo-Su

Permanent ON or OFF

Circuit anticipation

Power reserve 3 years for date, time and switching program

Accuracy +/- 1 sec./Day

0037 10	Power supply 230 V~ 50/60Hz 1 NO contact 250 V/50 Hz 16 A - cos $\phi$ = 1 28 programmes Shortest switching-time 1 min	1	5668	1
---------	--	---	------	---

### Multiple functions - daily or weekly time switch programme - 5 years clock working reserve

Programme settings: on daily or weekly basis

15 languages

A programme consists of a on and off time and their assignment to certain days

Option to suspend the programme for a specific period to set-up with start and date

Minimum programme setting: 1 s.

High precision clock:  $\pm$  0.1 sec per day

Particularly suited to irregular cycles:

- security installations (access point, alarms, etc.),

- industrial installations (pump stations, etc.)

Programmed directly on keypad, or using program transfer key Cat.No 4 128 72

Additional functions including random (irregular cycles), hour counters

4126 31	1 output 16 A - 250 V~ 50/60 Hz 56 programmes 1 Channel	2	6426	1
4126 41	2 output 16 A - 250 V~ 50/60Hz 2x28 programmes 2 Channel	2	9048	1



4106 57



4126 41

Bold Cat.Nos are products normally available with Legrand (India) Stockists. Cat.Nos that are not bold - delivery within 4 - 8 weeks from the date of order. Bold packing quantity is our mandatory packing. Orders to be placed by Legrand (India) Stockist in multiples of the same.

## DX<sup>3</sup> time switches

Cat.Nos	Description	No. of Modules	MRP* ₹ / Unit	Pack
---------	-------------	----------------	------------------	------

### Digital time switch with Astronomical Function

- For switching on/off lights and other electric devices according to the rising/setting of the sun
- With combination function for creating switching programs in which the devices are switched according to astronomical time and/or fixed preset times
- Daily astronomical calculation of the sunrise/sunset times based on the entered location or location coordinates



4126 54



4126 57

4126 54	1 output 16 A - 250 V~ 50/60 Hz Astronomical function 56 Programmes 1 Channel	2	11482	1
4126 57	2 output 16 A - 250 V~ 50/60 Hz Astronomical function 2x28 programmes 2 Channel	2	13102	1

### Alpharex<sup>3</sup> yearly time switch

- Yearly and weekly time switch with additional astronomical function for all channels
- 84 switching programs per channel, comprising:
  - 28 weekly programs
  - 28 yearly programs
  - 28 special programs (priority program)

4126 30	2 outputs - 230 V~ 50/60 Hz Astronomical function 2 x 3 x 28 = 168 programmes	2	21294	1
---------	---	---	-------	---

Cat.Nos	Description	MRP* ₹ / Unit	Pack
---------	-------------	------------------	------

### Programming accessories

4128 72	<b>Programming transfer key</b> Can be used to store programme settings made: Directly on a multifunction and multi-programme time switch Cat.Nos 4 126 30/31/32/33/41/54/57 (loading on device) -with the programming software installed on a PC running Windows (loading on data loader)	2392	1
4128 73	<b>Programming software Kit</b> Can be used to create, save and transfer program settings for multifunction and multi-program time switches. Data is transferred to the program transfer key using the data loader connected to the USB port of the PC. 4128 73 Kit comprising software on CD-ROM, data loader and transfer key Windows XP, Windows 7, Windows 8 compatible"	5172	1

\* MRP - Maximum Retail Price Inclusive of all taxes including GST.

<sup>1</sup> 1P+N and 3P+N: L-N and N-PE protection modes (common and differential modes), the N pole being protected by encapsulated spark gaps. Also called sometimes 1+1 and 3+1

## DX<sup>3</sup> time switches

Cat.Nos	Description	MRP* ₹ / Unit	Pack
---------	-------------	------------------	------

### Twilight switches

- Light sensitive switches
- Can be used to switch a lighting circuit "ON" and "OFF" based on light conditions (nightfall, daybreak)
- Supplied with IP 65 weatherproof photoelectric cell
- Adjustable from 1 to 100 000 lux

4126 23	Luxo Switch / Light sensitive switch with Lux Sensor - Output 16 A 250 V~	8132	1
---------	---	------	---

### MicroRex analog time switches

Programmed via captive segment  
Power supply: 230 V~ 50/60 Hz  
3-position override switch "ON-AUTO-OFF" on front panel  
Manual changeover to summer/winter time  
1 outlet 16 A - 250 V~ -  $\mu \cos = 1$

### Analogue Time Switch Daily programme

1 segment = 15 minutes  
Accuracy:  $\pm 5$  minutes  
1 outlet 16 A - 250 V~ -  $\mu \cos = 1$

4127 80	Vertical Dial N/O Contact - without working Reserve -Minimum switching time: 15 minutes	1	3320	1
4127 90	Vertical Dial N/O Contact - with 100 h working Reserve -Minimum switching time: 15 minutes	1	3910	1



4128 12

4128 12	Horizontal Dial Changeover Switch - without working Reserve -Minimum switching time: 15 minutes	3	5010	1
4128 13	Horizontal Dial Changeover Switch - with 100 h working Reserve -Minimum switching time: 15 minutes	3	6204	1

### Analogue Time Switch Weekly programme

1 segment = 2 hours  
Accuracy:  $\pm 30$  minutes  
1 outlet 16 A - 250 V~ -  $\mu \cos = 1$

4127 94	Vertical Dial N/O Contact - with 100 h working Reserve -Minimum switching time: 2 hours	1	4328	1
4127 95	Horizontal Dial Changeover Switch - with 100 h working Reserve -Minimum switching time: 4 hours	3	6270	1

## DX<sup>3</sup> contactors

### Power contactors / Modular Contactors CX<sup>3</sup>

Conform to IEC/EN 61095

Space for power supply busbar on top (up to 25 A)

Bold Cat.Nos are products normally available with Legrand (India) Stockists. Cat.Nos that are not bold - delivery within 4 - 8 weeks from the date of order. Bold packing quantity is our mandatory packing. Orders to be placed by Legrand (India) Stockist in multiples of the same.

## Power contactors / Modular Contactors CX<sup>3</sup>

Cat.Nos	Description	MRP* ₹ / Unit	Pack
---------	-------------	------------------	------

Power contactors with 230 V~ coil and handle  
Manual override for test and repair function, carried out via the handle  
Permanent "ON" or "OFF" without automatic closing of the contactor

4125 44	25 A 2 NO contactor	2382	1
4125 45	40 A 2 NO contactor	4070	1
4125 47	63 A 2 NO contactor	4736	1
4125 48	63 A 2 NC contactor	4736	1
4125 49	40 A 3 NO contactor	6806	1
4125 50	63 A 3 NO contactor	7696	1
4125 51	25 A 4 NO contactor	2812	1
4125 53	40 A 4 NO contactor	7182	1
4125 56	63 A 4 NO contactor	8504	1
4125 57	63 A 4 NC contactor	8584	1

### Signalling auxiliaries for contactors

Auxiliary changeover switch

4124 29	For 1 module contactors 16 A to 25 A	3596	1
4124 30	For 2 module contactors 25 A	3608	1
4124 31	For 40 and 63 A contactors	4736	1

## DX<sup>3</sup> for photovoltaic applications

Cat.Nos	Description	MRP* ₹ / Unit	Pack
---------	-------------	------------------	------

### DC MCBs

Breaking capacity 4.5 kA according to EN 60947-2

#### 800 V= circuit breakers

4144 24	6 A	7914	1
4144 25	8 A	7914	1
4144 26	10 A	7874	1
4144 27	13 A	7914	1
4144 28	16 A	8344	1
4144 29	20 A	7874	1

#### 1000 V= circuit breakers

4144 46	10 A	21102	1
4144 47	13 A	21102	1
4144 48	16 A	22360	1
4144 49	20 A	21102	1
4144 50	25 A	19904	1
4144 51	32 A	20800	1

### Type 2 voltage surge protectors

DC side protection of photovoltaic installations connected to the low voltage network (without energy storage system)

Conforming to UTE guide C 61-740-51 Protection in common mode and residual current mode (Y mode) 1  
Consisting of plug-in modules with LED indicator Red: modules need to be replaced

### Voltage surge protectors

\* MRP - Maximum Retail Price Inclusive of all taxes including GST.

<sup>1</sup> 1P+N and 3P+N: L-N and N-PE protection modes (common and differential modes), the N pole being protected by encapsulated spark gaps. Also called sometimes 1+1 and 3+1

<sup>2</sup> Replaced mid 2015 by Cat.No 4122 80

## DX<sup>3</sup> for photovoltaic applications Type 2 voltage surge protectors

Cat.Nos	Description	MRP* ₹ / Unit	Pack
---------	-------------	------------------	------

4141 55	600 V= 25KA I <sub>max</sub>	■	1
4141 56	1000 V 40KA I <sub>max</sub>	■	1

### Plug-in replacement module

4141 85	+/- cassette for voltage surge protector 4141 55	■	1
4141 86	T cassette for voltage surge protector 4141 56	■	1

### DC rotary handle isolating switches

Category of use DC 21B according to EN 60947-3

Double break contacts

#### 600 V= isolating switches

4142 61	16 A	9178	1
4142 62	25 A	10368	1
4142 63	32 A	10368	1

#### 1000 V= isolating switches

4142 81	16 A	17774	1
4142 82	25 A	17734	1
4142 83	32 A	18430	1

### Accessories

4063 05	Pole separation divider	152	1
4063 07	Spacing unit 0.5 unit	208	10

## Class I (T1) low voltage SPDs

Cat.Nos	Number of poles	Neutral position	I <sub>total</sub> (10/350)	Remote lightning monitoring contact (RMS)	Number of modules	MRP* ₹ / Unit
---------	-----------------	------------------	-----------------------------	---	-------------------	------------------

### SPDs for general protection of main distribution-board

#### T1+T2 - limp 12,5 kA/pole T2 - 60 kA

4122 70	1P	-	12.5 kA	No	1	9190
4122 76 <sup>1</sup>	1P+N	Right	25 kA	Yes	2	16170
4122 71	2P	-	25 kA	No	2	17748
4122 72	3P	-	37.5 kA	Yes	3	22002
4122 77 <sup>1</sup>	3P+N	Right	50 kA	Yes	4	29482
4122 73	4P	-	50 kA	No	4	26988

#### T1+T2 - limp 8 kA/pole T2 - 60 kA

4122 50	1P	-	8 kA	No	1	7678
4122 56 <sup>1</sup>	1P+N	Right	16 kA	No	2	13964
4122 51	2P	-	16 kA	No	2	14834
4122 52	3P	-	25 kA	No	3	20900
4122 57 <sup>1</sup>	3P+N	Right	25 kA	No	4	25402
4122 53	4P	-	32 kA	No	4	26922



4122 57

Bold Cat.Nos are products normally available with Legrand (India) Stockists. Cat.Nos that are not bold - delivery within 4 - 8 weeks from the date of order. Bold packing quantity is our mandatory packing. Orders to be placed by Legrand (India) Stockist in multiples of the same.

## Class I (T1) low voltage SPDs

Cat.Nos	Number of poles	Neutral position	Total (10/350)	Remote status monitoring (FS contact)	Number of modules	MRP* ₹ / Unit
---------	-----------------	------------------	----------------	---------------------------------------	-------------------	---------------

### SPDs for high risk level installations

#### T1 - limp 50 kA/pole - 440 V~ (IT) - Monobloc

0030 00	1P	-	50 kA	No	2	8948
---------	----	---	-------	----	---	------

#### T1 - limp 35 kA/pole - 440 V± (IT) - Plug-in

4122 80	1P	-	35 kA	Yes	2	20342
---------	----	---	-------	-----	---	-------

#### T1 - limp 25 kA/pole

4122 81 <sup>1</sup>	1P+N	Right	50 kA	Yes	4	26430
4122 82	3P	-	75 kA	Yes	6	63186
4122 83 <sup>1</sup>	3P+N	Right	100 kA	Yes	8	72526



4122 83

4123 03



4122 84

### Replacement plug-in modules

Cat.Nos	Description	MRP* ₹ / Unit	Pack
---------	-------------	---------------	------

4123 02	For SPDs T1+T2 - 8 kA Cat.Nos 4122 50/ 51/52/53/56/57	7290	1
4123 03	For SPDs T1+T2 - 12.5 kA Cat.Nos 4122 70/ 71/72/73/76/77	6878	1
4122 84	For SPDs T1 - 25 kA Cat.Nos 4122 81/82/83 and 0030 20/22/23/27	19796	1
4122 85	N-PE module for SPDs T1 - 25 kA Cat.Nos 4122 81/83 and 0030 23	26864	1
4122 86	For SPDs T1 - 35 kA Cat.No 4122 80	6640	1

### Cabling accessories

4123 10	Ready to use cabling kit consisting of 5 conductors (including the earth conductor) Cross section :16 mm <sup>2</sup> Lenght : 40 cm For cabling SPDs in industrial enclosures (for EN/IEC 61439 compliance).	1422	1
---------	--	------	---

## Class II (T2) low voltage SPDs

Cat.Nos	Number of poles	Neutral position	Remote status monitoring (FS contact)	Number of modules	MRP* ₹ / Unit	Pack
---------	-----------------	------------------	---------------------------------------	-------------------	---------------	------

### T2 SPDs

#### T2 - I<sub>max</sub> 40 kA/pole

4122 40	1P	-	No	1	5548	1
4122 46 <sup>1</sup>	1P+N	Right	No	2	10564	1
4122 41	2P	-	No	2	10564	1
4122 42	3P	-	Yes	3	15472	1
4122 47 <sup>1</sup>	3P+N	Right	No	4	18830	1
4122 43	4P	-	No	4	18830	1



4122 43

■ Price available on request.

\* MRP - Maximum Retail Price Inclusive of all taxes including GST.

<sup>1</sup> 1P+N and 3P+N: L-N and N-PE protection modes (common and differential modes), the N pole being protected by encapsulated spark gaps. Also called sometimes 1+1 and 3+1

<sup>2</sup> Replaced mid 2015 by Cat.No 4122 80

## Class II (T2) low voltage SPDs

Cat.Nos	Number of poles	Neutral position	Remote status monitoring (FS contact)	Number of modules	MRP* ₹ / Unit	Pack
---------	-----------------	------------------	---------------------------------------	-------------------	---------------	------

### T2 - I<sub>max</sub> 40 kA/pole - 440 V~ (IT)

4122 30	1P	-	No	1	7348	1
4122 32	3P	-	Yes	3	22002	1
4122 33	4P	-	Yes	4	26988	1

### T2 - I<sub>max</sub> 20 kA/pole

4122 20	1P	-	No	1	4308	1
4122 26 <sup>1</sup>	1P+N	Right	No	2	8264	1
4122 21	2P	-	No	2	8264	1
4122 27 <sup>1</sup>	3P+N	Right	No	4	15386	1
4122 23	4P	-	No	4	15386	1

### Replacement plug-in modules

Cat.Nos	Description	MRP* ₹ / Unit	Pack
---------	-------------	---------------	------

4122 99	For SPDs T2 - 40 kA Cat.Nos 4122 40/ 41/42/43/44/45/ 46/47/66/67	4692	1
4123 00	N-PE module for SPDs T2 - 40 kA Cat.Nos 4122 46/47	9392	1
4123 01	For SPDs T2 - 440 V Cat.Nos 4122 30/32/33	7222	1
4122 97	For SPDs T2 - 20 kA Cat.Nos 4122 20/ 21/23/26/27/62/63	3548	1
4123 98	N-PE module for SPDs T2 - 20 kA Cat.Nos 4122 24/25/26/27	7706	1



4122 99

## Class II (T2) low voltage SPDs with integrated protection

Cat.Nos	Number of poles	Neutral position	Integrated protection	Number of modules	MRP* ₹ / Unit	Pack
---------	-----------------	------------------	-----------------------	-------------------	---------------	------

### Protection for consumer units

#### T2 self protected SPDs - I<sub>max</sub> 12 kA/pole

0039 51 <sup>1</sup>	1P+N	Left	I <sub>sc</sub> ≤ 6 kA	2	10768	1
0039 53 <sup>1</sup>	3P+N	Left	I <sub>sc</sub> ≤ 6 kA	6	23490	1



0039 51



0039 53

### Protection for secondary distribution boards

#### T2 self protected SPDs - I<sub>max</sub> 12 kA/pole

0039 71 <sup>1</sup>	1P+N	Left	I <sub>sc</sub> ≤ 10 kA	2	10768	1
0039 73 <sup>1</sup>	3P+N	Left	I <sub>sc</sub> ≤ 10 kA	6	23490	1

Bold Cat.Nos are products normally available with Legrand (India) Stockists. Cat.Nos that are not bold - delivery within 4 - 8 weeks from the date of order. Bold packing quantity is our mandatory packing. Orders to be placed by Legrand (India) Stockist in multiples of the same.

# ACCL

## AUTOMATIC CHANGEOVER WITH CURRENT LIMITER

Seamless and uninterrupted switchover for smart spaces



→ Intelligent micro-controller based design

→ Automatic source change over between Mains & Generator supply

→ Manual reset for restoring supply in sleep mode

→ Break before make change over system

→ Direct mount on DIN rail channel

→ Buzzer and LED light indication of status-Overload, Mains, Gen

→ Current limitation function prevents over loading of the generator

→ Neutral isolation



Scan to know more about the product.



## Class II (T2) low voltage SPDs with integrated protection

Cat.Nos	Description	MRP* ₹ / Unit	Pack
---------	-------------	------------------	------

### Replacement plug-in modules

#### For self protected SPDs

0039 54	Cat.Nos 0039 51/53	7756	1
0039 74	Cat.Nos 0039 71/73	8022	1

### SPDs for telephone lines

Cat.Nos	In/Imax	Max. voltage (Uc)	Level of protection (Up)	No. of modules	MRP* ₹ / Unit	Pack
---------	---------	-------------------	--------------------------	----------------	------------------	------

#### SPDs for telephone and data lines

##### "Analogue" SPD (STN, non-unbundled ADSL, etc.)

0038 28	5/10 kA	170 V	260 V	1	14724	1
---------	---------	-------	-------	---	-------	---

##### "Digital" SPD (unbundled ADSL, SDSL, ISDN, etc.)

0038 29	5/10 kA	48 V	100 V	1	14972	1
---------	---------	------	-------	---	-------	---

### DX<sup>3</sup> changeover switches

Cat.Nos	Description	MRP* ₹ / Unit	Pack
---------	-------------	------------------	------

#### Changeover Switches

##### Single pole - two way - 250 V AC

4129 00	32 A	3726	10/100
---------	------	------	--------

##### Double pole - two way - 400 V AC

4129 01	32 A	3726	5/50
---------	------	------	------

##### Double pole - two way with centre off - 400 V AC

4129 03	32 A	3900	5/50
---------	------	------	------

##### Four pole - two way with centre off - 400 V AC

6040 22	40 A	5866	2/20
---------	------	------	------

## Automatic changeover with current limiter(ACCL)

Cat.Nos	Description	MRP* ₹ / Unit	Pack
---------	-------------	------------------	------

### Automatic changeover with current limiter(ACCL)

Intelligent micro controller based design

Automatic source change over between Mains &

Generator supply

Break before make change over system

Buzzer and Led Indication of status

Current limitation prevents overloading of the generator

405300	SPN 30/3A	2812	1/15
405301	SPN 30/4A	2812	1/15
405302	SPN 30/5A	2812	1/15
405303	SPN 30/6A	2812	1/15
405304	SPN 30/9A	2812	1/15
405305	SPN 30/12A	2812	1/15
405306	SPN 30/15A	2812	1/15
405307	SPN 30/20A	2812	1/15
405308	SPN 30/30A	2812	1/15

### DX<sup>3</sup> push button

#### Push button cum switch

Push button cum switch - 1 module - 20 A-250 V AC

#### Single function

4129 08	Contact 1 NO	3078	10/100
4129 09	Contact 1 NC	3078	10/60
4129 10	Contact 2 NO	3078	10/60



0039 54



0038 28



0038 29



4129 00



4129 08



6040 22

\* MRP - Maximum Retail Price Inclusive of all taxes including GST.

1 1P+N and 3P+N: L-N and N-PE protection modes (common and differential modes), the N pole being protected by encapsulated spark gaps. Also called sometimes 1+1 and 3+1

Bold Cat.Nos are products normally available with Legrand (India) Stockists. Cat.Nos that are not bold - delivery within 4 - 8 weeks from the date of order. Bold packing quantity is our mandatory packing. Orders to be placed by Legrand (India) Stockist in multiples of the same.

### DX<sup>3</sup> push button

Cat.Nos	Description	MRP* ₹ / Unit	Pack
---------	-------------	------------------	------

#### Dual function

4129 14	Contact - 1 NO + green indicator	3078	10/60
4129 15	Contact - 1 NC + red indicator	3078	10/60



4129 15

### DX<sup>3</sup> indicators

#### Single indicators - 1 module - 250 V AC

Possible to replace E10 lamps and diffusers.

E10 - 1.2 Watt, 230 V AC

4129 26	Colour - Green	816	10/100
4129 27	Colour - Red	816	10/100
4129 28	Colour - Orange	816	10/100
4129 29	Colour - Blue	816	10/100
4129 32	White + White + White	1586	10/100
4129 33	Red + Red + Red	1586	10/100
4129 34	Red + Yellow + Green	1632	10/100
4129 35	Red + Yellow + Blue	1632	10/100



4129 27

### Lexic time switches

Cat.Nos	Description	MRP* ₹ / Unit	Pack
---------	-------------	------------------	------

#### Multifunction time delay relay

- Supply voltage : 12 to 230 V AC 50/60 Hz and DC
- Output : 8 A - 250 V AC,  $\cos\phi = 1$
- Contact NO

0047 44	Multifunction time delay relay	13908	1
---------	-----------------------------------	-------	---



0047 44

#### Time lag switch

0047 02	Time lag switch long time (1 module)	7242	10/100
---------	---	------	--------

### Rex surface mounting time switches

#### MaxiRex

6499 15	MaxiRex 4QT (daily)	6830	1/30
6499 14A	MaxiRex 4QTB (daily with IP 53 box)	6950	1
6499 39	MaxiRex 5QW (weekly)	7570	1/30
6499 36A	MaxiRex 4QWB (weekly with IP 53 box)	8208	1



## Rex surface mounting time switches

Cat.Nos	Description	MRP* ₹ / Unit	Pack
---------	-------------	------------------	------

### EconoRex

0499 86	EconoRex MQT (24hrs.)	6794	1/30
---------	-----------------------	------	------

### Accessories

0498 32	Clip on support frame for fascia mounting of MaxiRex QTT and QWT	414	1/5
0044 09	DIN rail adaptor for MaxiRex QTT and QWT	272	1
0044 07	DIN rail adaptor for EconoRex BQTAP	272	1
6499 49	Terminal cover for 4/5 nominal time switch	346	1/30
6499 48	IP53 box for MaxiRex 4 and 5	1062	1/10

### Current transformers

- Used with ammeters, electricity meters
- Supply a current of 5 A to the secondary which is proportional to the primary current.
- Fix to plate or rail EN 60715

4121 01	<b>50/5</b> Precision in % - 1 Power in VA - 1.5	3176	1/12
4121 03	<b>100/5</b> Precision in % - 1 Power in VA - 1.5	4322	1/12

## Rex surface mounting time switches

Cat.Nos	Description	MRP* ₹ / Unit	Pack
---------	-------------	------------------	------

4121 06	<b>200/5</b> Precision in % - 0.5 Power in VA - 4	4322	1/12
4121 24	<b>200/5</b> Precision in % - 0.5 Power in VA - 5	4360	1/12
4121 25	<b>400/5</b> Precision in % - 0.5 Power in VA - 8	4516	1/12
4121 36	<b>600/5</b> Precision in % - 0.5 Power in VA - 12	4580	1/12
4121 38	<b>800/5</b> Precision in % - 0.5 Power in VA - 8	6712	1/12
4121 39	<b>1000/5</b> Precision in % - 0.5 Power in VA - 10	7096	1/12
4121 42	<b>1250/5</b> Precision in % - 0.5 Power in VA - 12	8274	1/12

# Ekinox

Smart Solutions

The Core Brick  
of your installation  
is now smarter

## Intelligent EI

Ekinox 3 Smart Distribution Board allows to measure, monitor and control energy from anywhere. Equipped with smart products like EMDX3, CX3 EMS & intelligent accessories. Ekinox 3 helps to evaluate electrical distribution in real time seamlessly.



VTPN MCCB + METER BOARD



Scan to know more about  
the product.





# Ekinox<sup>3</sup>

Smart Solutions

## MIVAN CONSTRUCTION COMPATIBLE EKINOX<sup>3</sup> DB



Mivan Construction Compatible Ekinox3 distribution boards are made with thick sheets to withstand extreme pressures during the Mivan construction process. The sleek, minimalistic and stylish design enhance the overall ambience of the spaces.

### SALIENT FEATURES

Easily removable knock outs for cable glanding

Full proof solution

Innovative door knob

Integrated door earthing system

Door separately packed

Plain look with rounded corners

Stronger glanding plates

Nut inserts for longer installation life

Increased sheet thickness to withstand Mivan Construction challenges

Slimmest DB with 71 mm depth

IP 43 degree of protection

Wire set, Din rail components, Neutral and Earth bar packed separately in inner assembly set



Scan to know more about the product.

## Ekinox<sup>3</sup> SPN DB's

for DX<sup>3</sup> MCB, Isolator, RCCB and RCBO

Cat.Nos	Number of ways	No. of modules	MRP* ₹ / Unit	Pack
---------	----------------	----------------	------------------	------

- As per IEC 61439-3
- Suitable for Flush Mounting and Surface Mounting
- With 100 A Copper Busbar
- With Neutral bar, Earthbar and Cable ties for Cable management
- Fully shrouded Neutral bars
- Prefitted masking sheet
- Reversible Door for IP 43 & IP 54 DB's

### IP 30 - #IK 08

5076 00	4 way	4	1722	1
5076 01	8 way	8	2072	1
5076 02	12 way	12	2450	1
5076 03	16 way	16	2990	1
5076 04	18 way	18	3480	1
5076 05	20 way	20	3576	1



5076 05

### IP 43 - #IK 09 with metal door

5076 10	4 way	4	2250	1
5076 11	8 way	8	2776	1
5076 12	12 way	12	3336	1
5076 13	16 way	16	4214	1
5076 14	18 way	18	4392	1
5076 15	20 way	20	5326	1



5076 12

### IP 43 - #IK 09 with acrylic door

5076 20	4 way	4	3006	1
5076 21	8 way	8	3482	1
5076 22	12 way	12	4230	1
5076 23	16 way	16	5256	1
5076 24	18 way	18	5602	1
5076 25	20 way	20	5934	1



5076 42

### IP 54 - #IK 09

5076 40	4 way	4	7966	1
5076 41	8 way	8	9452	1
5076 42	12 way	12	10858	1
5076 43	16 way	16	12082	1
5076 44	18 way	18	12334	1
5076 45	20 way	20	13404	1

## Ekinox<sup>3</sup> ETPN DB's

for DX<sup>3</sup> MCB, Isolator, RCCB and RCBO

- As per IEC 61439-3
- Suitable for Flush Mounting and Surface Mounting
- With 100 A Copper Busbar for each phase
- With Neutral bar, Earthbar and Cable ties for Cable management
- Fully insulated busbar & shrouded Neutral bars
- Improved Pan assembly for ease of installation
- Prefitted masking sheet
- Reversible Door for IP 43 & IP 54 DB's
- With provision for FP MCB/Isolator/RCCB/RCBO as incomer and SP MCB's as outgoing
- Supplied with wireset
- Can be converted to PPI DB at site using conversion kit

### IP 30 - #IK 08

5076 60	4 way	8+12	4792	1
5076 61	6 way	8+18	5946	1
5076 62	8 way	8+24	7022	1
5076 63	12 way	8+36	10108	1
5076 64	16 way	8+48	12456	1
5076 66	20 way	8+60	17216	1



5077 01



5077 11

## Ekinox<sup>3</sup> ETPN DB's

for DX<sup>3</sup> MCB, Isolator, RCCB and RCBO

Cat.Nos	Number of ways	No. of modules	MRP* ₹ / Unit	Pack
---------	----------------	----------------	------------------	------

### IP 43 - #IK 09 with metal door

5076 70	4 way	8+12	5544	1
5076 71	6 way	8+18	6904	1
5076 72	8 way	8+24	8282	1
5076 73	12 way	8+36	12402	1
5076 74	16 way	8+48	15378	1
5076 76	20 way	8+60	21726	1

### IP 43 - #IK 09 with acrylic door

5076 80	4 way	8+12	7558	1
5076 81	6 way	8+18	9154	1
5076 82	8 way	8+24	10876	1
5076 83	12 way	8+36	16684	1
5076 84	16 way	8+48	19938	1
5076 86	20 way	8+60	27746	1

### IP 54 - #IK 09

5076 90	4 way	8+12	19160	1
5076 91	6 way	8+18	23056	1
5076 92	8 way	8+24	25216	1
5076 93	12 way	8+36	35538	1
5076 94	16 way	8+48	42646	1
5076 96	20 way	8+60	50342	1

## Ekinox<sup>3</sup> Flexy DB

for DX<sup>3</sup> DIN modular products

Cat.Nos	Number of row	No. of modules	MRP* ₹ / Unit	Pack
---------	---------------	----------------	------------------	------

- As per IEC 61439-3
- Suitable for Flush Mounting and Surface Mounting
- Completely flexible to organise the distribution as per site requirements
- Busbars to be selected as per distribution requirements
- With Neutral and Earth bars
- Fully shrouded Neutral bars
- Improved Pan assembly for ease of installation
- Prefitted masking sheet
- Reversible door for IP 43

### IP 30 - #IK 08

5077 01	2 row of 14 M	28	5936	1
5077 02	3 row of 14 M	42	7432	1
5077 03	4 row of 14 M	56	8240	1

### IP 43 - #IK 09 with metal door

5077 05	2 row of 14 M	28	7010	1
5077 06	3 row of 4 M	42	8418	1
5077 07	4 row of 14 M	56	9170	1
5077 14	4 row of 8 M	32	7532	1
5077 15	4 row of 10 M	40	7810	1
5077 12	3 row of 14 M MCCB for DPX <sup>3</sup> 160 MCCB	42	9464	1

### IP 43 - #IK 09 with acrylic door

5077 09	2 row of 14 M	28	7408	1
5077 10	3 row of 14 M	42	9084	1
5077 11	4 row of 14 M	56	10294	1
5077 13	3 row of 14 M MCCB for DPX <sup>3</sup> 160 MCCB	42	10530	1

\* MRP - Maximum Retail Price Inclusive of all taxes including GST.  
#IK - Refer pg - 59 for ready reckoner table.

Bold Cat.Nos are products normally available with Legrand (India) Stockists. Cat.Nos that are not bold - delivery within 4 - 8 weeks from the date of order. Bold packing quantity is our mandatory packing. Orders to be placed by Legrand (India) Stockist in multiples of the same.

## Ekinox<sup>3</sup> TPN DB-VTPN DB's

for DX<sup>3</sup> MCB, Isolator, RCCB and RCBO

Cat.Nos	Number of ways	No. of modules	MRP* ₹ / Unit	Pack
---------	----------------	----------------	------------------	------

- As per IEC 61439-3
- Suitable for Flush Mounting and Surface Mounting
- With 100 A Copper Busbar for each phase
- With 2 Neutral bar, 2 Earthbar and Cable ties for Cable management
- Fully insulated busbar & shrouded Neutral bars
- Improved Pan assembly for ease of installation
- Prefitted masking sheet
- Reversible Door for IP 43 & IP 54 DB's
- With provision for FP MCB/Isolator/RCCB/RCBO as incomer and SP/TP MCB's as outgoing

### IP 30 - #IK 08

5077 20	4 way	8+12	12882	1
5077 21	6 way	8+18	14166	1
5077 22	8 way	8+24	15726	1
5077 23	12 way	8+36	22708	1

### IP 43 - #IK 09 with metal door

5077 25	4 way	8+12	13720	1
5077 26	6 way	8+18	15194	1
5077 27	8 way	8+24	17650	1
5077 28	12 way	8+36	23978	1

### IP 43 - #IK 09 with acrylic door

5077 30	4 way	8+12	18332	1
5077 31	6 way	8+18	20168	1
5077 32	8 way	8+24	23310	1
5077 33	12 way	8+36	31098	1

### IP 54 - #IK 09

5077 35	4 way	8+12	29040	1
5077 36	6 way	8+18	31948	1
5077 37	8 way	8+24	34930	1
5077 38	12 way	8+36	45662	1

## Ekinox<sup>3</sup> TPN DB-VTPN DPX<sup>3</sup> 160 MCCB DB's

- As per IEC 61439-3
- Suitable for Flush Mounting and Surface Mounting
- With 250 A Copper Busbar for each phase
- With 2 Neutral bar, 2 Earthbar and Cable ties for Cable management
- Fully insulated busbar & shrouded Neutral bars
- Improved Pan assembly for ease of installation
- Prefitted masking sheet
- Reversible Door for IP 43 & IP 54 DB's
- With provision for DPX<sup>3</sup> 160 MCCB as incomer and SP/TP MCB's as outgoing

### IP 30 - #IK 08

5077 40	4 way	DPX <sup>3</sup> 160+12	14566	1
5077 41	6 way	DPX <sup>3</sup> 160+18	15732	1
5077 42	8 way	DPX <sup>3</sup> 160+24	17002	1
5077 43	12 way	DPX <sup>3</sup> 160+36	25706	1

### IP 43 - #IK 09 with metal door

5077 45	4 way	DPX <sup>3</sup> 160+12	16562	1
5077 46	6 way	DPX <sup>3</sup> 160+18	18816	1
5077 47	8 way	DPX <sup>3</sup> 160+24	20710	1
5077 48	12 way	DPX <sup>3</sup> 160+36	28234	1

\* MRP - Maximum Retail Price Inclusive of all taxes including GST.  
#IK - Refer pg - 59 for ready reckoner table.

## Ekinox<sup>3</sup> TPN DB-VTPN DPX<sup>3</sup> 160 MCCB DB's

Cat.Nos	Number of ways	No. of modules	MRP* ₹ / Unit	Pack
---------	----------------	----------------	------------------	------

### IP 54 - #IK 09

5077 50	4 way	DPX <sup>3</sup> 160+12	34080	1
5077 51	6 way	DPX <sup>3</sup> 160+18	38806	1
5077 52	8 way	DPX <sup>3</sup> 160+24	42158	1
5077 53	12 way	DPX <sup>3</sup> 160+36	55540	1

## Ekinox<sup>3</sup> TPN DB-VTPN DPX<sup>3</sup> 250 MCCB DB's

- As per IEC 61439-3
- Suitable for Flush Mounting and Surface Mounting
- With 250 A Copper Busbar for each phase
- With 2 Neutral bar, 2 Earthbar and Cable ties for Cable management
- Fully insulated busbar & shrouded Neutral bars
- Improved Pan assembly for ease of installation
- Prefitted masking sheet
- Reversible Door for IP 43 & IP 54 DB's
- With provision for DPX<sup>3</sup> 250 MCCB as incomer and SP/TP MCB's as outgoing

### IP 30 - #IK 08

5077 55	4 way	DPX <sup>3</sup> 250+12	23826	1
5077 56	8 way	DPX <sup>3</sup> 250+24	25330	1
5077 57	12 way	DPX <sup>3</sup> 250+36	27956	1

### IP 43 - #IK 09 with metal door

5077 58	4 way	DPX <sup>3</sup> 250+12	27110	1
5077 59	8 way	DPX <sup>3</sup> 250+24	31224	1
5077 60	12 way	DPX <sup>3</sup> 250+36	32910	1

### IP 54 - #IK 09

5077 61	4 way	DPX <sup>3</sup> 250+12	40678	1
5077 62	8 way	DPX <sup>3</sup> 250+24	45944	1
5077 63	12 way	DPX <sup>3</sup> 250+36	53794	1

## Ekinox<sup>3</sup> TPN DB-Phase selector DB's for DX<sup>3</sup> MCB, Isolator, RCCB and RCBO

- As per IEC 61439-3
- With inbuilt 3 nos of 63 A Phase selector switches and 3 Nos Piano Switches
- Suitable for Flush Mounting and Surface Mounting
- With 100 A Copper Busbar for each phase
- With Neutral bar, Earthbar and Cable ties for Cable management
- Fully insulated busbar & shrouded Neutral bars
- With provision for FP MCB/Isolator/RCCB/RCBO as incomer and SP MCB's as outgoing
- Supplied with wire set

### IP 30 - #IK 08

5077 70	4 way	8+12	17750	1
5077 71	6 way	8+18	18878	1
5077 72	8 way	8+24	20918	1
5077 73	12 way	8+36	23164	1

### IP 43 - #IK 09 with metal door

5077 80	4 way	8+12	20354	1
5077 81	6 way	8+18	20678	1
5077 82	8 way	8+24	22152	1
5077 83	12 way	8+36	24942	1

Bold Cat.Nos are products normally available with Legrand (India) Stockists. Cat.Nos that are not bold - delivery within 4 - 8 weeks from the date of order. Bold packing quantity is our mandatory packing. Orders to be placed by Legrand (India) Stockist in multiples of the same.

## Ekinox<sup>3</sup> TPN DB - 7 segment DB's for DX<sup>3</sup> MCB, Isolator, RCCB and RCBO

Cat.Nos	Number of ways	No. of modules	MRP* ₹ / Unit	Pack
---------	----------------	----------------	------------------	------

- As per IEC 61439-3
- Separate compartment for incomer, sub-incomer & outgoing devices
- Suitable for Flush Mounting and Surface Mounting
- With 100 A Copper Busbar for each phase
- With Neutral bar, Earthbar and Cable ties for Cable management
- Fully insulated busbar & shrouded Neutral bars
- With provision for FP MCB/Isolator/RCCB/RCBO as incomer, DP RCCB/RCBO as sub incomer and SP MCB's as outgoing
- Supplied with wire set
- DB with phase segmentation and separation between incomer and outgoing

### IP 30 - #IK 08

5078 80	4 way	8+12+12	13344	1
5078 81	6 way	8+12+18	14136	1
5078 82	8 way	8+12+24	15360	1
5078 83	12 way	8+12+36	17644	1

### IP 43 - #IK 09 with metal door

5078 85	4 way	8+12+12	15064	1
5078 86	6 way	8+12+18	16966	1
5078 87	8 way	8+12+24	18946	1
5078 88	12 way	8+12+36	23552	1

## Ekinox<sup>3</sup> TPN DB - 7 segment DB's for 160 A DPX<sup>3</sup> MCCB

- As per IEC 61439-3
- DB with phase segmentation and separation between incomer and Outgoing
- Suitable for Flush Mounting and Surface Mounting
- With 100 A Copper Busbar for each phase
- With Neutral bar, Earthbar and Cable ties for Cable management
- Fully Color Shrouded Insulated bus bar and Neutral bars
- With provision for DPX<sup>3</sup> 160 MCCB as incomer DP MCB/Isolator/RCCB/RCBO as sub incomers and SP MCB's as outgoing
- Supplied with wire set

### IP 30 - #IK 08

5078 90	4 way	DPX <sup>3</sup>	18700	1
	160+12+12			
5078 91	6 way	DPX <sup>3</sup>	21514	1
	160+12+18			
5078 92	8 way	DPX <sup>3</sup>	24724	1
	160+12+24			
5078 93	12 way	DPX <sup>3</sup>	28704	1
	160+12+36			

\* MRP - Maximum Retail Price Inclusive of all taxes including GST.  
#IK - Refer pg - 59 for ready reckoner table.

## Ekinox<sup>3</sup> TPN DB - 7 segment DB's for 160 A DPX<sup>3</sup> MCCB

Cat.Nos	Number of ways	No. of modules	MRP* ₹ / Unit	Pack
---------	----------------	----------------	------------------	------

### IP 43 - #IK 09 with metal door

5078 95	4 way	DPX <sup>3</sup>	20692	1
	160+12+12			
5078 96	6 way	DPX <sup>3</sup>	23686	1
	160+12+18			
5078 97	8 way	DPX <sup>3</sup>	27388	1
	160+12+24			
5078 98	12 way	DPX <sup>3</sup>	30888	1
	160+12+36			

## Ekinox<sup>3</sup> Metra plug & socket DB's for DX<sup>3</sup> MCB, RCCB and RCBO

Cat.Nos	Description	No. of modules	MRP* ₹ / Unit	Pack
---------	-------------	----------------	------------------	------

- As per IEC 61439-3
- Suitable for Flush Mounting and Surface Mounting
- Suitable for protection of appliances like AC/Geysers etc
- Supplied with Neutral Links
- With provision for mounting modular devices

### #IK 08

5078 10	10 A SP, 2P+E	1	2212	1
5078 11	20 A SP, 2P+E	1	2382	1
5078 14	20 A DP, 2P+E	2	2588	1
5078 17	20 A TP, 3P+E	3	4386	1
5078 18	32 A TP, 3P+E	3	5204	1
5078 20	20 A DP RCBO, 2P+E	4	2504	1
5078 21	20 A FP RCBO, 2P+E	8	4378	1
5078 22	32 A FP RCBO, 3P+E	8	5164	1

## Ekinox<sup>3</sup> P-17 Tempra plug & socket DB's for DX<sup>3</sup> MCB, RCCB and RCBO

- As per IEC 61439-3
- Suitable for Flush Mounting and Surface Mounting
- Supplied with Neutral Links
- With provision for mounting modular devices

### #IK 08

5078 60	16 A 2P+E-DP	2	3614	1
5078 63	32 A 2P+E-DP	2	3904	1
5078 61	32 A 3P+E-FP	8	6538	1
5078 62	32 A 3P+N+E-FP	8	6614	1
5078 64	63 A 3P+N+E-FP	8	16460	1

Bold Cat.Nos are products normally available with Legrand (India) Stockists. Cat.Nos that are not bold - delivery within 4 - 8 weeks from the date of order. Bold packing quantity is our mandatory packing. Orders to be placed by Legrand (India) Stockist in multiples of the same.



5078 95



5078 86



5078 14



5078 22



5078 60



5078 62



5078 64

## Ekinox<sup>3</sup> Metal enclosures

for DX<sup>3</sup> MCB, RCCB, RCBO and DPX<sup>3</sup> MCCB's

Cat.Nos	Description	No. of modules	MRP* ₹ / Unit	Pack
---------	-------------	----------------	------------------	------

- As per IEC 61439-3
- For independent mounting of DX<sup>3</sup> MCB, RCCB, RCBO, DPX<sup>3</sup> 160, DPX<sup>3</sup> 250, DPX<sup>3</sup> 630 & DRX MCCB's
- #IK 08

### #IK 08

5077 90	SP enclosure	1	608	1
5077 91	DP enclosure	2	888	1
5077 92	TP enclosure	3	888	1
5077 93	FP enclosure	4	888	1
5077 94	FP RCBO enclosure	8	1494	1

### Metal one way enclosures for MCCB

5078 01	DPX <sup>3</sup> 160 MCCB enclosure	3&4	4982	1
5078 02	DPX <sup>3</sup> 250 MCCB enclosure	3&4	8846	1
5078 04	DPX <sup>3</sup> 630 MCCB enclosure	3&4	13410	1
5078 05	DRX 100 MCCB enclosure-TP	3	2662	1
5078 06	DRX 100 MCCB enclosure-FP	4	2510	1

### Ekinox<sup>3</sup> cable end box

Cat.Nos	Description	MRP* ₹ / Unit	Pack
---------	-------------	------------------	------

- Useful for keeping extra cables
- Possible to mount on the top or bottom of the DB
- Provision for mounting terminal blocks
- Can be used as a terminal box adaptor also

#### For IP 30 DB's

5079 10	For SPN 4 W IP30	872	1
5079 12	For SPN 8 W IP30	1002	1
5079 14	For SPN 12 W/ VTPN/Flexy	1098	1
5079 16	For SPN 16 W/ ETPN 6 way DB	1534	1
5079 25	For ETPN 8 way DB	2770	1
5079 27	For ETPN 12 way DB	3658	1
5079 29	For ETPN 16 way DB	3696	1
5079 31	For ETPN 18 way DB	4000	1
5079 33	For ETPN 20 way DB	4064	1
5079 35	For ETPN 4 way VTPN/FLEXY MCB	1098	1
5079 37	For all VTPN MCCB DBS	4084	1

#### For IP 43 DB's

5079 11	For SPN 4 way DB	974	1
5079 13	For SPN 8 way DB	1166	1
5079 15	For SPN 12 way/ VTPN/Flexy DB	1308	1

\* MRP - Maximum Retail Price Inclusive of all taxes including GST.  
#IK - Refer pg - 59 for ready reckoner table.

## Ekinox<sup>3</sup> cable end box

Cat.Nos	Description	MRP* ₹ / Unit	Pack
---------	-------------	------------------	------

#### For IP 43 DB's

5079 17	For SPN 16 way/ ETPN 6 way DB	1856	1
5079 18	For SPN 18 way DB	1894	1
5079 19	For SPN 20/ETPN 8 way DB	1940	1
5079 28	For ETPN 12 way DB	4206	1
5079 30	For ETPN 16 way DB	4244	1
5079 32	For ETPN 18 way DB	4594	1
5079 34	For ETPN 20 way DB	4666	1
5079 36	For all ETPN 4W/VTPN/Flexy MCB	1308	1
5079 38	For all VTPN MCCB DBs	4684	1
5079 00	For 7 segment 4 way DB	4320	1
5079 01	For 7 segment 6 way DB	4740	1
5079 02	For 7 segment 8 way DB	5288	1
5079 03	For 7 segment 12 way DB	5976	1

## Ekinox<sup>3</sup> DBs

### meter box

- Suitable for Mounting DX<sup>3</sup> Metering products
- Possible to mount on the top or bottom of the DB
- Provision for mounting Ammeter/Voltmeter/ASS/VSS
- #IK09

#### Provision for mounting meters

5079 40	For VTPN MCB INCOM IP 30	5506	1
5079 41	For VTPN MCB INCOM IP 43	6612	1
5079 42	For VTPN MCCB INCOM IP 30	6122	1
5079 43	For VTPN MCCB INCOM IP 43	7556	1

#### Per phase Isolation kit

5079 44	PPI conversion kit for ETPN 4 way DB	3222	1
5079 45	PPI conversion kit for ETPN 6 way DB	3634	1
5079 46	PPI conversion kit for ETPN 8 way DB	4204	1
5079 47	PPI conversion kit for ETPN 12 way DB	4684	1
5079 48	PPI conversion kit for ETPN 16 way DB	5262	1

#### Panel locks

5079 52	Panel knob for IP 43	362	1
5079 51	Panel knob with key	740	1

Bold Cat.Nos are products normally available with Legrand (India) Stockists. Cat.Nos that are not bold - delivery within 4 - 8 weeks from the date of order. Bold packing quantity is our mandatory packing. Orders to be placed by Legrand (India) Stockist in multiples of the same.



## Ekinox™ distribution boards

Cat.Nos	Number of ways	MRP* ₹ / Unit	Pack
---------	----------------	------------------	------

### Plexo3 boxes for DX<sup>3</sup>

Self-extinguishing: resistance to incandescent wire 650 °C

Conform to EN 60439-3

Weatherproof cabinets - IP 65 - IK 09 - Class II

Door and cabinet fully reversible

Removable chassis and faceplates from 2-row versions up

2-position rail for modular products and moulded cases

Spacing between rails 150 mm

Box colour light grey L750A, cover colour dark grey R746A



6019 94

6019 32	2 (+1) Module	1970	1
6019 94	4 Module	2102	1
6019 96	6 Module	2406	1
6019 98	8 Module	3006	1



6018 32

### Cabinets with 12 modules per row

6018 31	1 row 12 modules	4736	1
6018 32	2 rows 24 modules	6570	1
6018 33	3 rows 36 modules	9156	1

### Cabinets with 18 modules per row

6018 35	18 modules x 1 row	5840	1
6018 36	18 modules x 2 rows	10106	1
6018 37	18 modules x 3 rows	14210	1
6018 38	18 modules x 4 rows	22110	1



6018 32 +  
0019 17

### Multifunction sleeves for P17

0019 17	For 2 row cabinets	3830	1
0019 18	For 3 row cabinets	5740	1
0019 67	Joining kit	1084	1

**Ekinox**<sup>™</sup>  
Smart Solutions

## Metra Plug & Socket DB's

The Right Choice for all your application needs



Note: For Plexo3 Box with integrated Neutral & Earth Bars contact nearest Sales Office

\* MRP - Maximum Retail Price Inclusive of all taxes including GST.

Refer instruction manual for MIVAN (Aluminum shuttering) compatible DB's

## Distribution boards

Cat.Nos	No. of devices connected	No. of 17.5 mm modules	MRP* ₹ / Unit	Pack
---------	--------------------------	------------------------	------------------	------

### Supply busbars - insulated

63 A copper

#### Pin type

##### SP I/C & SP O/G

4049 26	13	13	388	1
4049 37	57	57	1510	1

##### SPN I/C & SPN O/G

4049 38	6	12	684	1
4049 39	28	56	2824	1

##### TPN I/C & SPN O/G

4049 40	5	12	702	3/30
4049 41	27	56	6896	5/10

##### TP I/C & TP O/G

4049 42	4	12	708	1
4049 43	19	57	6932	1

##### FP I/C & FP O/G

4049 44	3	12	1702	3/30
4049 45	14	56	6896	5/10

#### Fork type

##### SP I/C & SP O/G

4049 11	13	12	388	1
4049 12	57	57	1482	1

##### SPN I/C & SPN O/G250

4049 14	28	56	2824	1
---------	----	----	------	---

##### TP I/C & TP O/G

4049 17	4	12	702	1
4049 18	19	57	6896	1

##### FP I/C & FP O/G

4049 20	14	56	6896	5/10
---------	----	----	------	------

Cat.Nos	Description	MRP* ₹ / Unit	Pack
---------	-------------	------------------	------

### Accessories for fork and pin type busbars

4049 89	End caps for SP	8	6
4049 90	End caps for DP & TP	46	6
4049 91	End caps for FP	84	20/840

Cat.Nos	Number of ways	MRP* ₹ / Unit	Pack
---------	----------------	------------------	------

### Blanking plates

6014 70	-	16	10
---------	---	----	----

Bold Cat.Nos are products normally available with Legrand (India) Stockists. Cat.Nos that are not bold - delivery within 4 - 8 weeks from the date of order. Bold packing quantity is our mandatory packing. Orders to be placed by Legrand (India) Stockist in multiples of the same.

## Ekinox<sup>3</sup>

For converting ETPN DB to PPI DB

### PPI DB IP 30 - IK 08

No. of ways	Combine		No. of modules
	ETPN DB	PPI Kit	
4 way	4 way 507660	4 way kit 507944	8+12
6 way	6 way 507661	6 way kit 507945	8+18
8 way	8 way 507662	8 way kit 507946	8+24
12 way	12 way 507663	12 way kit 507947	8+36
16 way	16 way 507664	16 way kit 507948	8+48

### PPI DB IP 43 - IK 09 with metal door

No. of ways	Combine		No. of modules
	ETPN DB	PPI Kit	
4 way	4 way 507670	4 way kit 507944	8+12
6 way	6 way 507671	6 way kit 507945	8+18
8 way	8 way 507672	8 way kit 507946	8+24
12 way	12 way 507673	12 way kit 507947	8+36
16 way	16 way 507674	16 way kit 507948	8+48

### PPI DB IP 43 - IK 09 with acrylic door

No. of ways	Combine		No. of modules
	ETPN DB	PPI Kit	
4 way	4 way 507680	4 way kit 507944	8+12
6 way	6 way 507681	6 way kit 507945	8+18
8 way	8 way 507682	8 way kit 507946	8+24
12 way	12 way 507683	12 way kit 507947	8+36
16 way	16 way 507684	16 way kit 507948	8+48

### PPI DB IP 54 - IK 09

No. of ways	Combine		No. of modules
	ETPN DB	PPI Kit	
4 way	4 way 507690	4 way kit 507944	8+12
6 way	6 way 507691	6 way kit 507945	8+18
8 way	8 way 507692	8 way kit 507946	8+24
12 way	12 way 507693	12 way kit 507947	8+36
16 way	16 way 507694	16 way kit 507948	8+48

## IK

Protection against mechanical impact: protection index - IK

According to standard:

IEC 62262, BS EN 62262 and NF EN 62262

• This table can be used to ascertain the resistance of a product to an impact given in Joules from the IK code (graduated from 00 to 10)

It can also be used to ascertain the correspondence with the old IP code 3rd digit and the corresponding external "Ag" conditions

IK	Tests	Impact energy (in Joules)	"AG" of NF C 15-100
IK 00		0	
IK 01		0.15	
IK 02		0.2	AG1
IK 03		0.35	
IK 04		0.5	
IK 05		0.7	
IK 06		1	
IK 07		2	AG2
IK 08		5	AG3
IK 09		10	
IK 10		20	AG4

## IPXX

### Index of protection

IP\*\*\* index of protection of enclosures of electrical equipment in accordance with standards IEC 529, BS 5490, DIN 400 50 and NF C 20-010

Up to 1000 V± and 1500 V= (standard UTE C 20 010)

#### 1st figure:- protection against solid bodies

IP	tests	
0		No protection
1		Protected against solid bodies larger than 50 mm (eg:- accidental contact with the hand)
2		Protected against solid bodies larger than 12 mm (eg:- finger)
3		Protected against solid bodies larger than 2.5 mm (eg:- tools, wires)
4		Protected against solid bodies larger than 1 mm (eg:- fine tools and small wires)
5		Protected against dust (no harmful deposit)
6		Completely protected against dust

#### 2nd figure:- protection against liquids

IP	tests	
0		No protection
1		Protected against vertically-falling drops of water (condensation)
2		Protected against drops of water falling at up to 15° from the vertical
3		Protected against drops of rain water at up to 60° from the vertical
4		Protected against projections of water from all directions
5		Protected against jets of water from all directions
6		Protected against jets of water of similar force to heavy seas
7		Protected against the effects of immersion
8		Protected against prolonged effects of immersion under pressure

The contents of all the above charts are for guidance only, if you have any doubt as to the interpretation of the information contained therein, please refer either to the standard itself or contact Legrand.

In accordance with our policy of continuous improvement, Legrand reserves the right to change specifications and designs without notice. All information given here is correct at the time of going to press.

# SUPER COMPACT (SCP)

THE POWER SOLUTIONS FOR INDUSTRIAL AND SERVICE SECTOR APPLICATION

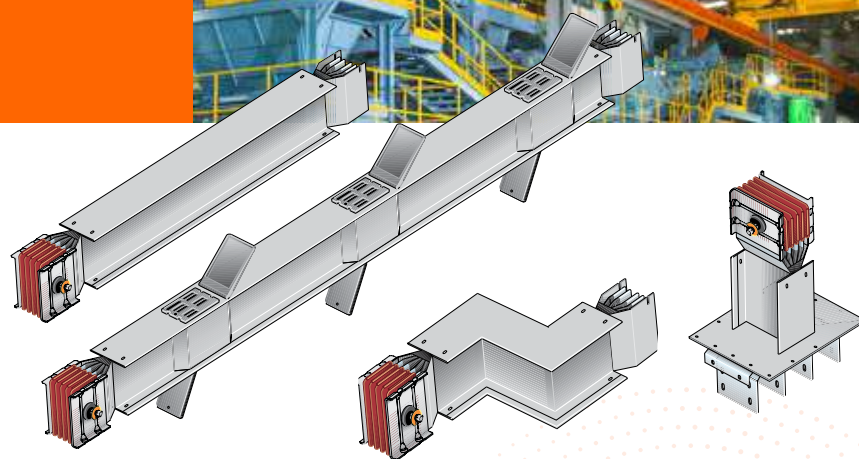

## FEATURES

- Availability in the standard range from 630 A to 5000 A\* with Aluminum alloy conductors and from 800 A to 6300 A\* with copper conductors.
- Low impedance of the circuit;
- Availability with a wide selection of tap-off boxes that range from 63 A upto 1250 A, thus allowing you to locally protect and feed different types of loads by housing protective devices such as fuses, MCCBs and motorized switches.
- Compliance with the IES 61439-6 standard

## ULTRA- COMPACT SIZES

- The super-compact dimensions enhance its resistance to short circuit stresses; in addition. They can reduce the impedance of the circuit by controlling the voltage drops and allow for the installation of high power electrical systems, even in extremely confined spaces.



Horizontal elbow



Vertical elbow



Connection interface



Junction



Scan to know more about the product.

# ARTEOR™

VERSATILITY AND A  
GLOBAL VISION FOR ANY  
INSTALLATION LEVEL

Arteor™ is the innovative answer to the increasingly complex requirements in the building business all over the world. Arteor™ excels by its unique aesthetics and a rich choice of innovative designs and ergonomical options. The range extends from wiring devices, through innovative IoT based solutions, up to fully networked home automation systems based on BUS technology, which can also be integrated into third party solutions.



Scan to know more about  
the product.

# ARTEOR™

DESIGN FOR A GLOBAL LIFESTYLE



## DESIGN OPTIONS FOR CONTROL FUNCTIONS

Arteor™ offers a wide choice of ergonomics and finishes to satisfy the most demanding customers. All stand-alone control functions are available in two shapes of rockers – round or square – and in three colours – white, magnesium and champagne.



Round rocker  
White



Round rocker  
Magnesium



Round rocker  
Champagne



Square rocker  
White



Square rocker  
Magnesium



Square rocker  
Champagne





# ARTEOR™

**HOME**

THE IDEAL SOLUTION,  
ALWAYS AND  
EVERYWHERE

Its versatility makes Arteor™ the ideal choice for every kind of project, anywhere in the world at any installation level. Arteor™ suits any requirement in terms of design and function for every kind of building, from residential to commercial.



TV socket



Bell push



Fan regulator



Skirting light



1-way switch - 3 gang



Switch & socket



Power unit



6AX switch\*



Skirting light



PIR Sensor



USB charger



Triple RCA socket



Time delay switch

\*Switch compatible with LED light

# ARTEOR™

## OFFICE AND HOTEL SOLUTIONS

Offices and collective spaces require specific solutions and maximum flexibility: lighting adapted to each situation (meeting, conference, etc.), access security, comprehensive multimedia connections. The Arteor™ range meets all these expectations with perfect adaptability.

OFFICE

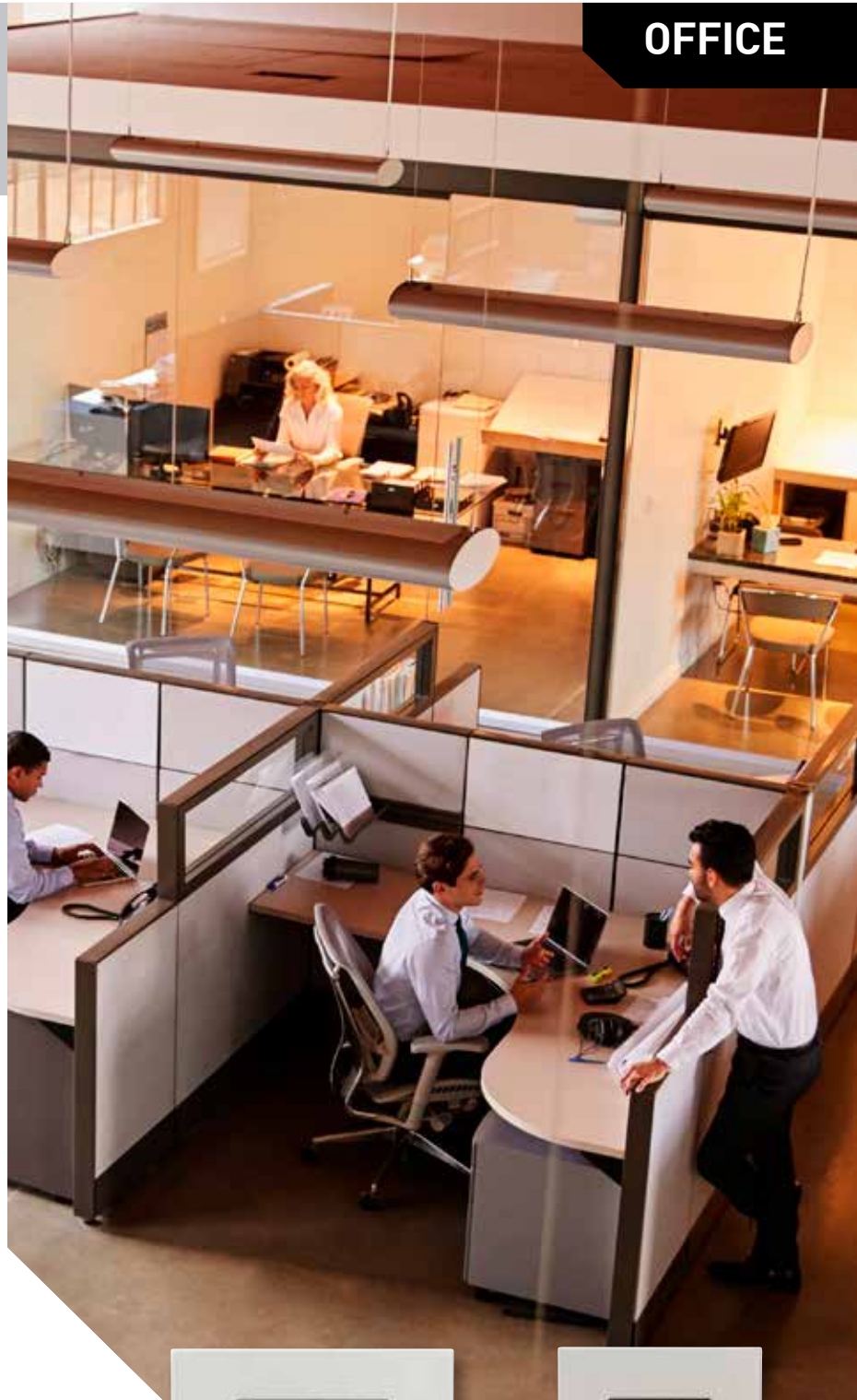

Automatic switch



6 A 1 way switch



USB socket



RJ45



Preterminated HDMI sockets



Female HD15 + Jack



Universal touch dimmer\*



Universal dimmer\*

\*For all loads including LED



**HOTEL**

From hotel room door to the beside table, Arteor™ provides all the solutions for the specific need of today's hotel industry. Comfort that extends to the hotel's communal areas, whether dedicated to the relaxation or work. The multitude of small details, gives the comfort feeling of being at home to the traveller.



Data sockets



4-Scenario touch control



S-Video socket



Keycard switch



External unit



Desk and entrance light



TV/R/SAT



Bed light and curtain aswitch



Internal unit

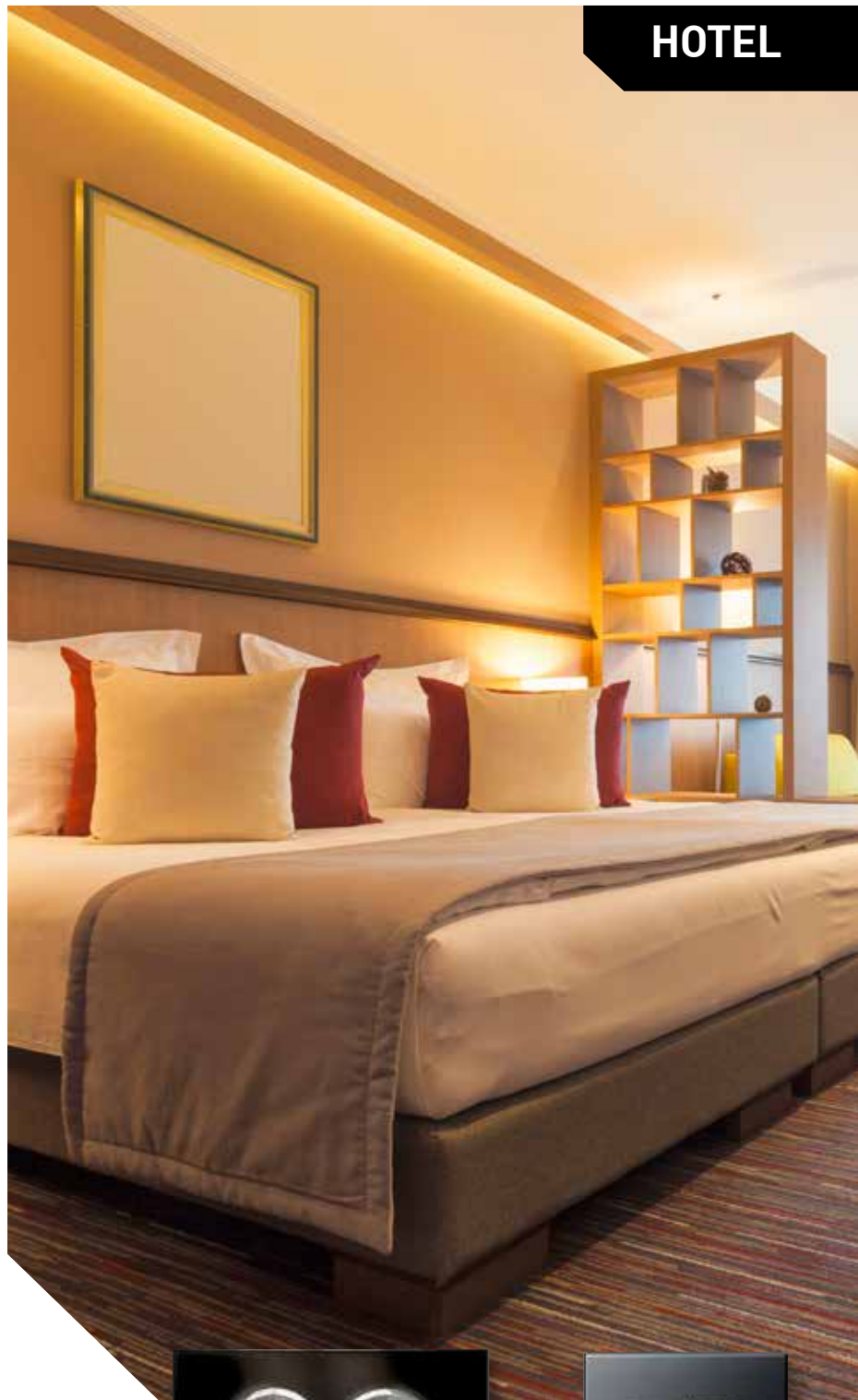

# ARTEOR™

A RICH CHOICE  
OF FINISHES

## NEUTRAL



## MIRROR



## GRAPHIC



## METAL





Graphite



Dark Bronze



Green Apple

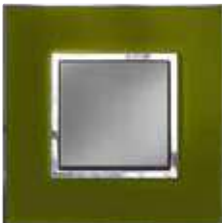

Dark Baroque



**WOOD**

Grey Oak



**SIGNATURE**

Cube

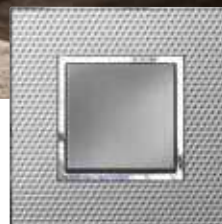

# ARTEOR™

VERSATILITY AND  
MODULARITY FOR  
UNRIVALLED  
FLEXIBILITY

Arteor™ is a modular range offering maximum flexibility in terms of installation and configuration.



## Features that set ARTEOR™ apart



- ① Finger-proof terminals for IP 20 protection against accidental contact.
- ② Captive "never to loose screws"



- ① Tunnel terminals preventing screwdrivers from slipping.
- ② Laser marking on mechanisms. Arrow showing the correct orientation of the mechanism.
- ③ The latest IS 3854 : 1997.

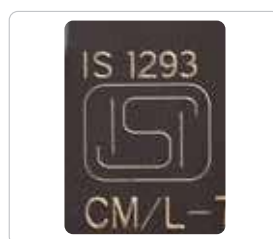

Sockets with ISI mark, conforming to IS 1293. Fan regulator with ISI mark, conforming to IS 11037.



Fully shrouded internal mechanism under the rocker preventing visibility of sparks.



- ① Stripping templates on sockets for stripping off exact length of insulation.



Sockets are shuttered for child's safety against electric shocks.



Possibility of weather proofing mechanisms using Plexo IP 55 and IP 66 boxes.



For switches with LED lamps, life of LED is 50000 burning hours. Consumes power (0.76W) next to NIL.

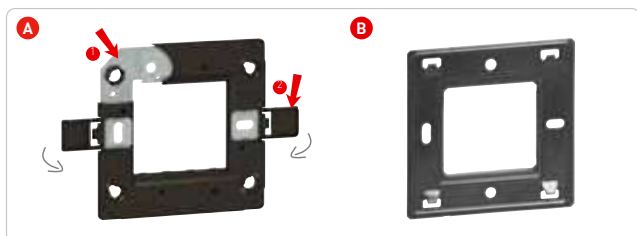

A. For all high end plates  
Metal frame providing solid support to base.  
Bi-material frame - electrical safety IP20.  
Screw caps can be closed once the support frame is installed, ensuring total insulation.



2x2 way switch - 3 controls possible in 2 module plate. In round and square design possible.



Mechanisms compatible with DLP trunking systems, columns, floor boxes and VDI installations.

# ARTEOR™ MyHOME\_UP

## THE BEAUTIFUL SIMPLICITY OF HOME AUTOMATION

Put the finishing touch to your homes with the hometouch screen. get total control of your home with just a touch. see the full range of home automation solutions provided by arteor MyHOME\_Up on [legrand.co.in](http://legrand.co.in)





# THE FINISHING TOUCH





## Arteor™ square - white mechanisms

Cat.Nos	Description	MRP* ₹ / Unit	Pack
---------	-------------	------------------	------

### Switches – 6 A - 250 V AC

5734 00	Switch - 6 A - SP - 1 way 1 module	208	20/200
5734 01	Switch - 6 A - SP - 1 way with indicator - 1 module	346	20/200
5734 02	Switch - 6 A - SP - 2 way 1 module	306	20/200
5734 03	Switch - 6 A - SP - 2 way with indicator - 1 module	432	20/200

### Switches – 10 A - 250 V AC

5734 50	Switch - 10 A - SP - 1 way 2 module	354	10/100
5734 51	Switch - 10 A - SP - 2 way 2 module	420	10/100
5720 37	Switch - 10 A - SP - 2 way with indicator & label holder - 2 module	1988	10/100
5720 38	Intermediate switch - 2 module	2378	10/100

### Switches – 20 A - 250 V AC

5734 10	Switch - 20 A - SP - 1 way - 1 module	406	20/200
5734 52	Switch - 20 A - SP - 1 way - 2 module	482	10/100
5720 63	Switch - 20 A - SP - 1 way with indicator - 1 module	418	20/200
5734 11	Switch - 20 A - SP - 2 way with indicator - 1 module	586	20/200
5720 42	Switch - 20 A - SP - 2 way with indicator - 2 module	636	10/100
5720 43	Switch - 20 A - 3 gang - 1 way - 2 module	1142	10/100
5720 44	Switch - 20 A - 3 gang - 2x2 way + 1x1 way - 2 module	1250	10/100
5734 54	Switch - 20 A - DP - 1 way with indicator - 2 module	898	10/100
5720 49	Switch - 20 A - DP - 1 way with indicator and water heater marking - 2 module	942	10/100

### Accessory for switch with indicator

5738 06	LED for switch with indicator (blue)	72	5/50
---------	---	----	------

### Switches – 25 A - 230 V AC

5734 17	25 A switch with indicator	542	20/200
---------	----------------------------	-----	--------

### Switches – 32 A / 40 A - 250 V AC

5734 12	Switch - 32 A - DP - 1 way with indicator - 2 module	1280	10/100
5735 30	Switch - 40 A - DP - 1 way with indicator - fits on 1/2 module box	1478	1/5/20

\* MRP - Maximum Retail Price Inclusive of all taxes including GST.  
■ Price available on request

## Arteor™ square - white mechanisms

Cat.Nos	Description	MRP* ₹ / Unit	Pack
---------	-------------	------------------	------

### Push button – 6 A - 250 V AC

5734 13	Bell push - 6 A - SP - 1 way - 1 module	328	20/200
5734 59	Bell push - 6 A - SP - 1 way - 2 module	460	10/100
5734 04	Push button - 6 A - SP - 1 way - 1 module	346	20/200
5734 05	Push button- 6 A-SP - 1 way with indicator - 1 module	438	20/200
5734 14	Bell push - 6 A-SP - 1 way with indicator - 1 module	432	20/200
5734 60	Bell push - 6 A-SP - 1 way with indicator - 2 module	616	10/100

### Electric roller blinds control

5722 20	Double switch for electric shutter - 2 module	800	10/100
---------	--	-----	--------

### Dimmers and fan regulators

5734 62	Light dimmer 60 to 400 watts - 2 module	1286	10/100
5734 16	Fan step regulator 100 watts - 1 module	1062	1/5/50
5734 63	Fan step regulator 100 watts - 2 module	1312	1/10/100
5734 69	Fan step regulator 120 watts - 2 module (for 48 & 56" fans)	1396	1/10/100
5734 68	Fan step regulator - 2 module for energy saving fans	1392	1/10/100
5736 53	Fan regulator - 8 Step - 100W - 2 module	1244	1/10/100

Bold Cat.Nos are products normally available with Legrand (India) Stockists.  
Cat.Nos that are not bold - delivery within 4 - 8 weeks from the date of order.  
Bold packing quantity is our mandatory packing. Orders to be placed by  
Legrand (India) Stockist in multiples of the same.

## Arteor™ square - white mechanisms

## Arteor™ square - white mechanisms



5722 39

Cat.Nos	Description	MRP* ₹ / Unit	Pack
<b>Electronic dimmers</b>			
5734 65	Universal touch dimmer 3 M	8054	1/10
5722 39	Universal dimmer without neutral 400 W - 2 module	11794	1/10

### Indian standard sockets

5734 70	Socket shuttered - 6 A - 2/3 pin - universal India 2 module	404	20/200
5734 71	Socket shuttered - 6/16 A - 3 pin - Indian - 2 module	538	10/100
5734 67	Socket shuttered - 6/16 A - 3 pin - Indian - 3 module	644	5/50
5734 72	Socket - 13 A - 3 pin - 2P+E BS - 2 module	840	10/100
5735 10	Socket with switch - 16 A - 3 pin - 2P+E - Indian - 3 module	1516	5/50
5720 59	Socket - 15/16 A - 2P - Euro/US - 1 module	430	10/100
5737 79	Socket - 6 A/13 A/15 A for 127 V, - double multistandard - 4 module	932	5/50
5734 73	Multistandard socket - 6/10/13 A - 2/3 pin for 250 V AC, 15 A for 127 V type - 2 pin - 2 module	508	10/100
5734 66	25 A socket - 2 module	652	10/100
5721 16	Euro/US - 15 A-127 V/16 A - 250 V, 2P + E with shutter 2 module	754	10/100
<b>5734 24</b>	Socket - 6A - ISI - 3 pin-2 module	266	1/20/200

**NEW!**



5738 88



5734 22

**NEW!**



5734 27



5734 75



5734 25



5734 43

Cat.Nos	Description	MRP* ₹ / Unit	Pack
---------	-------------	------------------	------

### Energy plugs

5738 86	6 A plug	132	1/10/100
5738 88	16 A plug	174	1/10/100
5738 07	25 A plug	198	1/10/100

### USB chargers (IS13252 (Part 1) / IEC 60950-1)

5734 41	USB charger 1 M 1500 mA	2056	1/5/50
5734 22	Double USB charger 2 M 2400 mA	2852	1/10/100

### Combi (Socket + USB)

5734 18	Combi twin USB charger 3.1A type A & A with Euro Socket - 2 module	2110	1/10/100
5734 19	Combi twin USB charger 3.1A type A & C with Euro Socket - 2 module	2462	1/10/100
5734 20	Combi twin USB charger 3.1A type C & C with Euro Socket - 2 module	3202	1/10/100

### RJ 11 telephone sockets (Jack type)

5734 27	Telephone socket - double RJ11 - 1 module	474	20/200
5734 26	Telephone socket - RJ11 with shutter - 1 module	276	20/200

### Information outlets - toolless

5734 29	Information socket - category 5e-UTP - 1 module	664	20/200
5734 75	Information socket - category 5e-UTP - 2 module	710	10/100
5734 28	Information socket - category 6-UTP - 1 module	1018	20/200
5734 74	Information socket - category 6-UTP - 2 module	1068	10/100

### TV sockets

5734 25	TV Co-Axial socket - 1 module	286	20/200
---------	----------------------------------	-----	--------

### Electronic chime

5734 43	Bell ding dong 230V - 2 module	432	1/10/100
---------	-----------------------------------	-----	----------

### Buzzer

5734 42	Buzzer - 230 V - 1 module	1544	20/200
---------	------------------------------	------	--------

### Bell call indicator & register - 6A - 250V AC

5734 15	Bell call indicator with register - 6 A - 1 way - SP - 1 module	1930	20/200
5736 06	Set of labels for bell call indicator (1-20)	522	5/50

### Lighting

5734 64	Skirting light with LED - 230 V - 3 module	1038	1/5/25
5722 26	Skirting light with detector (LED) - 230 V - 2 module	16766	1/20

\* MRP - Maximum Retail Price Inclusive of all taxes including GST.  
■ Price available on request

Bold Cat.Nos are products normally available with Legrand (India) Stockists.  
Cat.Nos that are not bold - delivery within 4 - 8 weeks from the date of order.  
Bold packing quantity is our mandatory packing. Orders to be placed by  
Legrand (India) Stockist in multiples of the same.

## Arteor™ square - white mechanisms

Cat.Nos	Description	MRP* ₹ / Unit	Pack
---------	-------------	------------------	------

### Lighting

5722 34	Miniature emergency skirting light unit - 2 module	10468	1/20
5724 53	Over door light unit (Red) 2 module	584	10/100
5722 23	Over door light unit (White) 2 module	478	10/100
5724 52	Indicator unit with transparent LED with coloured labels - 1 module	776	10/100

### Power strip and power units

5737 80	Set of 3 multistandard socket + Switch pre-wired - 8 module	2764	1/10
5735 42 <sup>(1)</sup>	1 Power unit (AC & Geyser) 16 A - 4 module	1708	1/5
5721 54	Power unit (AC & Geyser) 32 A (with cable output)	1924	1/5

### MCB

5723 61	MCB - 16 A-SPN - 2 module	4408	1
---------	---------------------------	------	---

### Protectors

5734 40	Surge protector - 1 module	4668	20/200
5734 48	Surge protector - 2 module	5368	10/100

### Hotel "DND and MMR" functions

5734 61	DND and MMR indicator with bell push 1+1 module	2074	5/50
5734 58	Internal control unit for DND & MMR 1+1 module	1486	10/100

### Hotel keycard switch

5722 44	16 A key card switch 230 V 2 module	5662	1/20
5722 59	Key fob for above	1544	10/50

### Shaver socket

5721 53	Shaver socket 230 V / 120 - 230 V with earth connector	5888	1
---------	--	------	---

### Infrared sensors

5740 47	PIR sensor with neutral 2 module	8702	1/20
5740 09	PIR sensor without neutral - 2 module	8150	1/20

### Time switch

5720 55	Time delay switch 2 module	7440	1/20
---------	----------------------------	------	------

### Audio-video sockets

5722 72	Double RCA socket (audio) 1 module	4522	1/20
5722 73	Triple RCA socket (audio & video) 1 module	4054	1/20

## Arteor™ square - white mechanisms

Cat.Nos	Description	MRP* ₹ / Unit	Pack
---------	-------------	------------------	------

### Audio-video sockets

5722 74	Female 3.5 mm Jack - 1 module	4496	1/20
5722 76	Female BNC 75 jack - 1 module	4746	1/20
5722 83	Female XLR jack - 2 module	6978	1/20
5720 97	Preterminated sockets Female HD15 - 1 module	6262	1
5720 96	Preterminated sockets HDMI 1.4 - 1 module	7432	1
5722 84	Line dying down 100 V (25-30W) 2 module	11624	1
5722 77	Male XLR jack 2 module	6382	1/20
5722 78	Female 3.5 mm Jack - solder - 1 module	3710	1/20
5722 75	USB socket - 1 module	3494	1/20
5744 01	S-VIDEO socket - 1 module	4086	1/40
5722 88	Female HD15 + Jack 3.5 mm - 2 module	5042	1/20

### Cable outlet

5734 80	45 A cable outlet 2 module	1154	5/50
5734 33	Cord outlet with 8 mm diameter - 1 module	368	20/200
5734 79	Standard cord outlet - 2 module	526	10/100

### Blanking plate

5734 49	1 module blank	56	20/200
5723 44	2 modules blank	82	10/100
5758 10	Blanking plate + frame - 2 module	490	10/100

### Mounting accessories for panel

5760 15	Panel mounting support - 1 module	308	10/100
5760 16	Panel mounting support - 2 module	324	10/100
5760 50	DIN rail support 2 module	386	10/100

### Square - magnesium mechanisms

#### Switches - 6 A - 250 V AC

<b>5736 00</b>	Switch - 6 A-SP - 1 way - 1 module	238	20/200
<b>5736 01</b>	Switch - 6 A-SP - 1 way with indicator - 1 module	396	20/200
<b>5736 02</b>	Switch - 6 A-SP - 2 way - 1 module	354	20/200
<b>5736 03</b>	Switch - 6 A-SP - 2 way with indicator - 1 module	506	20/200

#### Switches - 10 A - 250 V AC

5736 50	Switch - 10 A-SP - 1 way - 2 module	380	10/100
5736 51	Switch - 10 A-SP - 2 way - 2 module	446	10/100

\* MRP - Maximum Retail Price Inclusive of all taxes including GST.

■ To be Introduced Shortly

(1) Supplied with white plate

■ Price available on request

Bold Cat.Nos are products normally available with Legrand (India) Stockists. Cat.Nos that are not bold - delivery within 4 - 8 weeks from the date of order. Bold packing quantity is our mandatory packing. Orders to be placed by Legrand (India) Stockist in multiples of the same.

## Arteor™ square - white mechanisms

Cat.Nos	Description	MRP* ₹ / Unit	Pack
---------	-------------	------------------	------

### Switches – 10 A - 250 V AC

5725 37	Switch - 10 A-SP - 2 way with indicator & label holder- 2 module	2240	10/100
5725 38	Intermediate switch - 2 module	2738	10/100

### Switches – 20 A - 250 V AC

5736 10	Switch - 20 A-SP - 1 way 1 module	460	20/200
5736 52	Switch - 20 A-SP - 1 way 2 module	540	10/100
5725 63	Switch - 20 A-SP - 1 way with indicator -1 module	482	20/200
5736 11	Switch - 20 A-SP - 2 way with indicator -1 module	660	20/200
5725 42	Switch - 20 A-SP - 2 way with indicator - 2 module	708	10/100
5725 43	Switch - 20 A-3 gang - 1 way - 2 module	1312	10/100
5725 44	Switch - 20 A-3 gang - 2x2 way + 1x1 way - 2 module	1370	10/100
5736 54	Switch 20 A-DP - 1 way with indicator - 2 module	1062	10/100
5725 49	Switch - 20 A-DP - 1 way with indicator and water heater marking - 2 module	1130	10/100

### Switches – 25 A - 230 V AC

5736 17	25A switch with indicator	606	20/200
---------	---------------------------	-----	--------

### Switches – 32 A / 40 A - 250 V AC

5736 12	Switch - 32 A-DP - 1 way with indicator - 2 module	1478	10/100
---------	--	------	--------

## square - magnesium mechanisms

### Push button – 6 A - 250 V AC

5736 13	Bell push - 6 A-SP- 1 way - 1 module	368	20/200
5736 59	Bell push - 6 A-SP - 1 way - 2 module	526	10/100
5736 04	Push button - 6 A-SP - 1 way -1 module	382	20/200
5736 05	Push button - 6 A-SP - 1 way with indicator - 1 module	508	20/200
5736 14	Bell push - 6 A-SP - 1 way with indicator - 1 module	506	20/200
5736 60	Bell push - 6 A-SP - 1 way with indicator - 2 module	704	10/100

### Electric roller blinds control

5727 20	Double switch for electric shutter - 2 module	924	10/100
---------	---	-----	--------

### Dimmers and fan regulators

5736 62	Light dimmer - 60 to 400 watts - 2 module	1482	10/100
---------	---	------	--------

\* MRP - Maximum Retail Price Inclusive of all taxes including GST.  
■ Price available on request

## Arteor™ square - magnesium mechanisms

Cat.Nos	Description	MRP* ₹ / Unit	Pack
---------	-------------	------------------	------

### Dimmers and fan regulators

5736 16	Fan step regulator - 100 watts - 1 module	1218	1/5/50
5736 63	Fan step regulator - 100 watts - 2 module	1508	1/10/100
5736 69	Fan step regulator - 120 watts - 2 module ( for 48 & 56" fans )	1612	1/10/100
5736 68	Fan step regulator - 2 module for energy saving fan	1596	1/10/100
5736 56	Fan regulator - 8 Step - 100W - 2 module	1432	1/10/100

### Electronic dimmer

5727 39	Universal dimmer without neutral 400 W - 2 module	12762	1/10
---------	---	-------	------

### Indian standard sockets

5736 70	Socket shuttered - 6 A - 2/3 pin - universal Inzdia - 2 module	466	20/200
5736 71	Socket shuttered - 6/16 A - 3 pin - Indian - 2 module	616	10/100
5736 67	Socket shuttered - 6/16 A - 3 pin - Indian - 3 module	754	5/50
5736 72	Socket - 13 A - 3 pin - 2P+E BS - 2 module	972	10/100
5737 10	Socket with switch - 16 A - 3 pin - 2P+E - Indian 3 module	1742	5/50
5720 86	Socket - 15/16 A - 2P - Euro/US - 1 module	500	10/100
5739 79	Socket w - 6 A/13 A/15 A for 127 V, - double multistandard - 4 module	1070	5/50
5736 73	Multistandard socket - 6/10/13 A - 2/3 pin for 250 V AC 15 A for 127 V type - 2 pin 2 module	570	10/100
5736 66	25 A socket - 2 module	752	10/100
5726 16	Euro/US 15 A-127 VA/16 A 230 V 2P+E with shutter 2 M	894	10/100
5736 24	Socket - 6A - ISI - 3 pin - 2 module	312	1/20/200

### USB chargers (IS13252 (Part 1) / IEC 60950-1)

5734 44	USB charger 1M 1500 mA	2372	1/5/50
5736 22	Double USB charger 2M 2400mA	3280	1/10/100

Bold Cat.Nos are products normally available with Legrand (India) Stockists. Cat.Nos that are not bold - delivery within 4 - 8 weeks from the date of order. Bold packing quantity is our mandatory packing. Orders to be placed by Legrand (India) Stockist in multiples of the same.



5736 11



5725 44



5725 49



5736 59



5736 14



5727 20



5736 16



5727 39



5736 70



5736 71



5739 79

NEW!

## Arteor™ square - magnesium mechanisms

Cat.Nos	Description	MRP* ₹ / Unit	Pack
---------	-------------	------------------	------

### NEW! Combi (Stock + USB)

<b>5736 18</b>	Combi twin USB charger 3.1A type A & A with Euro Socket - 2 module	2426	1/10/100
<b>5736 19</b>	Combi twin USB charger 3.1A type A & C with Euro Socket - 2 module	2832	1/10/100
<b>5736 20</b>	Combi twin USB charger 3.1A type C & C with Euro Socket - 2 module	3680	1/10/100



5736 27

### RJ 11 telephone sockets (Jack type)

<b>5736 27</b>	Telephone socket - double RJ11 - 1 module	542	20/200
<b>5736 26</b>	Telephone socket - RJ11 with shutter - 1 module	330	20/200

### Information outlets - toolless

<b>5736 29</b>	Information socket - category 5e - UTP - 1 module	762	20/200
<b>5736 75</b>	Information socket - category 5e - UTP - 2 module	824	10/100
<b>5736 28</b>	Information socket - category 6 - UTP - 1 module	1164	20/200
<b>5736 74</b>	Information socket - category 6 - UTP - 2 module	1224	10/100



5736 28

### TV sockets

<b>5736 25</b>	TV Co-Axial socket - 1 module	336	20/200
----------------	----------------------------------	-----	--------



5736 25

### Electronic chime

<b>5736 43</b>	Bell ding dong 230 V - 2 module	464	10/100
----------------	------------------------------------	-----	--------



5736 42

### Buzzer

<b>5736 42</b>	Buzzer- 230 V - 1 module	1692	20/200
----------------	--------------------------	------	--------

### Bell call indicator & register - 6A - 250V AC

<b>5736 15</b>	Bell call indicator with register - 6 A - 1 way - SP - 1 module	2228	20/200
----------------	---	------	--------

### Lighting

<b>5735 64</b>	Skirting light with LED - 230 V - 3 module	1194	1/5/25
<b>5727 26</b>	Skirting light with detector (LED) - 230 V - 2 module	19276	1/20



5735 64

\* MRP - Maximum Retail Price Inclusive of all taxes including GST.  
 # To be Introduced Shortly  
 (1) Supplied with white plate  
 ■ Price available on request

## Arteor™ square - magnesium mechanisms

Cat.Nos	Description	MRP* ₹ / Unit	Pack
---------	-------------	------------------	------

### Power strip and power units (without plate)

<b>5739 80</b>	Set of 3 multistandard socket + switch pre-wired - 8 module	3168	1/10
<b>5737 42<sup>(9)</sup></b>	Power unit (AC & Geyser) 16 A - 4 module	2014	1/5
<b>5726 54</b>	Power unit (AC & Geyser) 32 A (with cable output) 4 module	2254	1/5



5737 42

### Hotel "DND and MMR " functions

<b>5736 61</b>	DND and MMR indicator with bell push 1+1 module	2378	5/50
<b>5736 58</b>	Internal control unit for DND & MMR 1+1 module	1722	10/100



5736 61

### Hotel keycard switch

<b>5727 44</b>	16 A Key card switch 230 V with time delay - 2 module	6236	1/20
<b>5727 59</b>	Key fob for above	2144	10/50



5727 44

### Shaver socket

<b>5726 53</b>	Shaver socket 230 V / 120-230 V with earth connector	6484	1
----------------	--	------	---



5726 53

### Infrared sensors

<b>5740 97</b>	PIR sensor with neutral - 2 module	10012	1/20
<b>5740 59</b>	PIR sensor without neutral - 2 module	9974	1/20

### Time switch

<b>5740 84</b>	Time delay switch - 2 module	8236	1/20
----------------	---------------------------------	------	------

### Audio-video sockets

<b>5727 72</b>	Double RCA socket (audio) - 1 module	5632	1/20
<b>5727 73</b>	Triple RCA socket (audio & video) - 1 module	4392	1/20
<b>5727 74</b>	Female 3.5 mm Jack - 1 module	4996	1/20
<b>5727 76</b>	Female BNC 75 jack - 1 module	4860	1/20
<b>5727 83</b>	Female XLR jack - 2 module	8740	1/20
<b>5725 97</b>	Preterminated sockets Female HD15 - 1 module	6892	1



5727 73



5727 74

### Audio-video sockets

<b>5725 96</b>	Preterminated sockets HDMI 1.4 - 1 module	7812	1
<b>5727 84</b>	Line dying down 100 V (25-30 W) 2 module	13990	1
<b>5727 75</b>	USB socket - 1 module	3904	1/20

Bold Cat.Nos are products normally available with Legrand (India) Stockists.  
 Cat.Nos that are not bold - delivery within 4 - 8 weeks from the date of order.  
 Bold packing quantity is our mandatory packing. Orders to be placed by  
 Legrand (India) Stockist in multiples of the same.



## Arteor™ square - magnesium mechanisms

Cat.Nos	Description	MRP* ₹ / Unit	Pack
5744 51	S-VIDEO socket - 1 module	3350	1/40
5727 88	Female HD15 + Jack 3.5 mm - 2 module	5484	1/20

### Blanking plate

5736 49	1 module blank	56	20/200
5728 44	2 modules blank	92	10/100

### Dedicated switches

5738 00	Dedicated switch - 6 A - 1 way - SP - red - 1 module	292	20/200
5738 01	Dedicated switch - 10 A - 1 way - SP - red - 1 module	302	20/200
5738 02	Dedicated switch - 20 A - 1 way - DP - red - 1 module	1066	5/40

### Tamper proof and dedicated sockets

5738 08	Tamperproof red Indian socket 6 A (2/3 pin) - 2 module	818	20/200
5738 10	Dedicated socket with switch - 16 A - 3 pin - 2P+E - Indian - 3 module	2138	5/50
5738 09	Insert for tamper proof Indian socket - 6 A	108	1/20/200

## Square - Champagne mechanisms

### Switches - 6 A - 250 V AC

5748 00	Switch - 6 A-SP - 1 way - 1 module	238	20/200
5748 01	Switch - 6 A-SP - 1 way with indicator - 1 module	396	20/200
5748 02	Switch - 6 A-SP - 2 way - 1 module	354	20/200
5748 03	Switch - 6 A-SP - 2 way with indicator - 1 module	506	20/200

### Switches - 10 A - 250 V AC

5748 04	Switch - 10 A-SP - 1 way - 2 module	380	10/100
5748 05	Switch - 10 A-SP - 2 way - 2 module	446	10/100
5748 06	Switch - 10 A-SP - 2 way with indicator & label holder - 2 module	2240	10/100
5748 07	Intermediate switch - 2 module	2738	10/100

### Switches - 20 A - 250 V AC

5748 08	Switch - 20 A-SP - 1 way 1 module	460	20/200
5748 09	Switch - 20 A-SP - 1 way 2 module	540	10/100

## Arteor™ square - champagne mechanisms

Cat.Nos	Description	MRP* ₹ / Unit	Pack
---------	-------------	------------------	------

### Switches - 20 A - 250 V AC

5748 10	Switch - 20 A-SP - 1 way with indicator - 1 module	482	20/200
5748 11	Switch - 20 A-SP - 2 way with indicator - 1 module	660	20/200
5748 12	Switch - 20 A-SP - 2 way with indicator - 2 module	708	10/100
5748 13	Switch - 20 A-3 gang - 1 way - 2 module	1312	10/100
5748 14	Switch - 20 A-3 gang - 2x2 way + 1x1 way - 2 module	1370	10/100
5748 15	Switch 20 A-DP - 1 way with indicator - 2 module	1062	10/100
5748 16	Switch - 20 A-DP - 1 way with indicator and water heater marking - 2 module	1130	10/100

### Switches - 25 A - 230 V AC

5748 17	25A switch with indicator	606	20/200
---------	---------------------------	-----	--------

### Switches - 32 A / 40 A - 250 V AC

5748 18	Switch - 32 A-DP - 1 way with indicator - 2 module	1478	10/100
5748 19	Switch - 40 A-DP - 1 way with indicator - fits on 1/2 module box	1700	1/5/20

### Push button - 6 A - 250 V AC

5748 23	Bell push - 6 A-SP - 1 way - 1 module	368	20/200
5748 24	Bell push - 6 A-SP - 1 way - 2 module	526	10/100
5748 21	Push button - 6 A-SP - 1 way - 1 module	382	20/200
5748 22	Push button - 6 A-SP - 1 way with indicator - 1 module	508	20/200
5748 25	Bell push - 6 A-SP - 1 way with indicator - 1 module	506	20/200
5748 26	Bell push - 6 A-SP - 1 way with indicator - 2 module	704	10/100

### Electric roller blinds control

5748 20	Double switch for electric shutter - 2 module	924	10/100
---------	---	-----	--------

### Dimmers and fan regulators

5748 27	Light dimmer - 60 to 400 watts - 2 module	1530	10/100
5748 29	Fan step regulator - 100 watts - 1 module	1218	1/5/50
5748 30	Fan step regulator - 100 watts - 2 module	1508	1/10/100
5748 31	Fan step regulator - 120 watts - 2 module ( for 48 & 56" fans )	1612	1/10/100
5748 32	Fan step regulator - 2 module for energy saving fan	1596	1/10/100
5736 57	Fan Regulator - 8 Step - 100W - 2 Module	1432	1/10/100



5736 49



5738 01



5738 08



5748 00



5748 01



5748 05



5748 07



5748 10



5748 11



5748 12



5748 13



5748 14



5748 15



5748 16

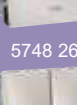

5748 17

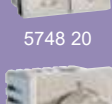

5748 18

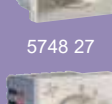

5748 19

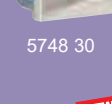

5748 20



5748 21



5748 22

\* MRP - Maximum Retail Price Inclusive of all taxes including GST.

Red Cat.Nos - new products

■ Price available on request.

Bold Cat.Nos are products normally available with Legrand (India) Stockists. Cat.Nos that are not bold - delivery within 4 - 8 weeks from the date of order. Bold packing quantity is our mandatory packing. Orders to be placed by Legrand (India) Stockist in multiples of the same.

## Arteor™ square - champagne mechanisms

Cat.Nos	Description	MRP* ₹ / Unit	Pack
---------	-------------	------------------	------

### Indian standard sockets

5748 33	Socket shuttered - 6 A - 2/3 pin - universal India - 2 module	464	20/200
5748 34	Socket shuttered - 6/16 A - 3 pin - Indian - 2 module	616	10/100
5748 35	Socket shuttered - 6/16 A - 3 pin - Indian - 3 module	754	5/50
5748 39	Socket w - 6 A/13 A/15 A for 127 V, - double multistandard - 4 module	1070	5/50
5748 40	Multistandard socket - 6/10/13 A - 2/3 pin for 250 V AC 15 A for 127 V type - 2 pin 2 module	570	10/100
5748 41	25 A socket - 2 module	752	10/100
<b>5748 84</b>	Socket - 6A - ISI - 3 pin - 2 module	312	1/20/200

### USB chargers (IS13252 (Part 1) / IEC 60950-1)

5734 47	USB charger 1M 1500 mA	2372	1/5/50
5748 44	Double USB charger 2M 2400mA	3280	1/10/100

### Combi (Socket + USB)

5748 78	Combi twin USB charger 3.1A type A & A with Euro Socket - 2 module	2426	1/10/100
5748 79	Combi twin USB charger 3.1A type A & C with Euro Socket - 2 module	2832	1/10/100
5748 80	Combi twin USB charger 3.1A type C & C with Euro Socket - 2 module	3680	1/10/100

### RJ 11 telephone sockets (Jack type)

5748 45	Telephone socket - double RJ11 - 1 module	542	20/200
5748 46	Telephone socket - RJ11 with shutter - 1 module	330	20/200

### Information outlets - toolless

5748 47	Information socket - category 5e - UTP - 1 module	762	20/200
5748 48	Information socket - category 5e - UTP - 2 module	818	10/100
5748 49	Information socket - category 6 - UTP - 1 module	1164	20/200
5748 50	Information socket - category 6 - UTP - 2 module	1224	10/100

\* MRP - Maximum Retail Price Inclusive of all taxes including GST.  
 \* To be Introduced Shortly  
 Red Cat.Nos - new products  
 (1) Supplied with white plate  
 ■ Price available on request

## Arteor™ square - champagne mechanisms

Cat.Nos	Description	MRP* ₹ / Unit	Pack
---------	-------------	------------------	------

### TV sockets

5748 51	TV Co-Axial socket - 1 module	336	20/200
---------	-------------------------------	-----	--------

### Electronic chime

5748 52	Bell ding dong 230 V - 2 module	464	10/100
---------	---------------------------------	-----	--------

### Buzzer

5748 53	Buzzer- 230 V - 1 module	1692	20/200
---------	--------------------------	------	--------

### Bell call indicator & register - 6A - 250V AC

5748 54	Bell call indicator with register - 6 A - 1 way - SP - 1 module	2228	20/200
---------	---	------	--------

### Lighting

5748 55	Skirting light with LED - 230 V - 3 module	1194	1/5/25
---------	--	------	--------

### Hotel "DND and MMR" functions

5748 56	DND and MMR indicator with bell push 1+1 module	2378	5/50
5748 57	Internal control unit for DND & MMR 1+1 module	1722	10/100

### Hotel keycard switch

5748 58	16 A Key card switch 230 V with time delay - 2 module	6236	1/20
5727 59	Key fob for above	2144	10/50

### Blanking plate

5748 63	1 module blank	56	20/200
5748 64	2 modules blank	92	10/100

## Round - champagne mechanisms

### Switches - 6 A - 250 V AC













5733 00	Switch - 6 A-SP - 1 way left - 1 module	300	20/200
5733 01	Switch - 6 A-SP - 1 way right - 1 module	300	20/200
5733 12	Switch - 6 A-SP - 1 way - middle - 1 module	300	20/200
5733 05	Switch - 6 A-SP - 2 way - left - 1 module	366	20/200
5733 06	Switch - 6 A-SP - 2 way - right - 1 module	366	20/200
5733 02	Switch - 6 A-SP - 1 way with indicator - left - 1 module	418	20/200
5733 04	Switch - 6 A-SP - 1 way with indicator - right - 1 module	418	20/200
5733 03	Switch - 6 A-SP - 1 way with indicator - middle - 1 module	418	20/200
5733 07	Switch - 6 A-SP - 2 way with indicator - left - 1 module	524	20/200
5733 08	Switch - 6 A-SP - 2 way with indicator - right - 1 module	524	20/200

Bold Cat.Nos are products normally available with Legrand (India) Stockists. Cat.Nos that are not bold - delivery within 4 - 8 weeks from the date of order. Bold packing quantity is our mandatory packing. Orders to be placed by Legrand (India) Stockist in multiples of the same.

## Arteor™ round - white mechanisms

Cat.Nos	Description	MRP* ₹ / Unit	Pack
---------	-------------	------------------	------







### Switches – 20 A - 250 V AC

 5733 20	Switch - 20 A-SP - 1 way - left - 1 module	490	20/200
 5733 21	Switch - 20 A-SP - 1 way - right - 1 module	490	20/200
 5730 21	Switch - 20 A-SP - 1 way - middle - 1 module	496	20/200
 5733 40	Switch - 20 A-SP - 1 way - 2 module	568	10/100
 5720 64	Switch - 20 A-SP - 1 way with indicator-left - 1 module	504	20/200
 5720 65	Switch - 20 A-SP - 1 way with indicator-right - 1 module	504	20/200
 5730 24	Switch - 20 A-SP - 2 way - middle - 1 module	504	20/200
 5733 22	Switch - 20 A-SP - 2 way with indicator-left - 1 module	700	20/200
 5733 23	Switch - 20 A-SP - 2 way with indicator-right - 1 module	700	20/200
 5730 71	Switch - 20 A-SP - 2 way with indicator - 2 module	620	10/100
 5730 72	Switch - 20 A-3 gang - 1 way - 2 module	1368	10/100
 5730 73	Switch - 20 A-3 gang - 2x2 way+1x1 way - 2 module	1504	10/100
 5733 42	Switch 20 A-DP - 1 way with indicator - 2 module	1062	10/100

### Switches - 32 A

 5733 26	Switch - 32 A-DP - 1 way with indicator - 2 module	1542	10/100
---	--	------	--------





### Push button – 6 A - 250 V AC

 5733 31	Bell push - 6 A-SP - 1 way - right - 1 module	382	20/200
 5733 30	Bell push - 6 A-SP - 1 way - left - 1 module	382	20/200
 5733 46	Bell push - 6 A-SP - 1 way - 2 module	542	10/100
 5733 09	Push button - 6 A-SP - 1 way - left - 1 module	412	20/200
 5733 11	Push button - 6 A-SP - 1 way - right - 1 module	412	20/200
 5733 47	Bell push - 6 A-SP - 1 way with indicator - 2 module	738	10/100
 5733 10	Push button - 6 A-SP - 1 way - middle - 1 module	412	20/200

### Electric roller blinds control

 5732 20	Double pole switch 10 A - 2 module	964	10/100
---	------------------------------------	-----	--------

### Dimmers and fan regulators

 5730 66	Light dimmer - 60 to 400 Watts - 2 module	1548	1/10/100
 5730 03	Fan step regulator - 100 Watts - 2 module	1574	1/10/100
 5730 69	Fan step regulator - 120 Watts - 2 module	1702	1/10/100
 5730 04	Fan step regulator - 2 module for energy saving fans	1666	1/10/100

\* MRP - Maximum Retail Price Inclusive of all taxes including GST.  
■ Price available on request.

## Arteor™ round - white mechanisms

Cat.Nos	Description	MRP* ₹ / Unit	Pack
---------	-------------	------------------	------

### Electronic dimmer

 5743 19	Universal dimmer without neutral 400 W - 2 module	13064	1/10
---	---	-------	------

### Multistandard sockets

 5734 89	Multistandard socket 6/10/13 A - 2/3 pin for 250 V AC 15 A for 127 V type - 2 pin 2 module	580	10/100
---	--	-----	--------



### USB chargers (IS13252 (Part 1) / IEC 60950-1)

 5734 23	Double USB charger 2M 2400mA	3158	1/10/100
---	------------------------------	------	----------



### Information outlets - toolless

 5723 24	Information socket - category 6-UTP - 2 module	1362	10/100
---	--	------	--------

### Hotel internal control units

 5720 74	Internal control unit for DND & MMR - 1+1 module	2082	5/50
 5720 67	DND & MMR indicator with bell push - 2 module	2616	5/40

### Audio-video sockets







 5732 72	Double RCA socket (audio) - 2 module	3216	1/20
 5732 73	Triple RCA socket (audio & video) - 2 module	4042	1/20
 5745 01	S-VIDEO socket - 2 module	4638	1/20

### Blanking plate





 5730 87	2 modules blank	94	10/100
---	-----------------	----	--------

### Round - magnesium mechanisms

#### Switches - 6 A - 250 V AC

 5733 50	Switch - 6 A-SP - 1 way - left - 1 module	346	20/200
 5733 51	Switch - 6 A-SP - 1 way - right - 1 module	346	20/200
 5733 62	Switch - 6 A-SP - 1 way - middle - 1 module	346	20/200
 5733 55	Switch - 6 A-SP - 2 way - left - 1 module	424	20/200
 5733 56	Switch - 6 A-SP - 2 way - right - 1 module	424	20/200
 5733 52	Switch - 6 A-SP - 1 way with indicator - left - 1 module	468	20/200

#### Switches - 6 A - 250 V AC

 5733 54	Switch - 6 A-SP - 1 way with indicator - right - 1 module	468	20/200
 5733 53	Switch - 6 A-SP - 1 way with indicator - middle - 1 module	478	20/200
 5733 57	Switch - 6 A-SP - 2 way with indicator - left - 1 module	606	20/200
 5733 58	Switch - 6 A-SP - 2 way with indicator - right - 1 module	606	20/200

Bold Cat.Nos are products normally available with Legrand (India) Stockists. Cat.Nos that are not bold - delivery within 4 - 8 weeks from the date of order. Bold packing quantity is our mandatory packing. Orders to be placed by Legrand (India) Stockist in multiples of the same.

## Arteor™ round - magnesium mechanisms

Cat.Nos	Description	MRP* ₹ / Unit	Pack
---------	-------------	------------------	------

### Switches - 20 A - 250 V AC

5733 70	Switch - 20 A-SP - 1 way - left - 1 module	544	20/200
5733 71	Switch - 20 A-SP - 1 way - right - 1 module	544	20/200
5731 21	Switch - 20 A-SP- 1 way - middle - 1 module	544	20/200
5733 90	Switch - 20 A-SP - 1 way - 2 module	646	10/100
5725 64	Switch - 20 A-SP - 1 way with indicator - left - 1 module	568	20/200
5725 65	Switch - 20 A-SP - 1 way with indicator - right - 1 module	568	20/200
5731 24	Switch - 20 A-SP - 2 way - middle - 1 module	578	20/200
5733 72	Switch - 20 A-SP - 2 way with indicator - left - 1 module	794	20/200
5733 73	Switch - 20 A-SP - 2 way with indicator - right - 1 module	794	20/200
5731 71	Switch - 20 A-SP - 2 way with indicator - 2 module	754	10/100
5731 72	Switch - 20 A-3 gang - 1 way- 2 module	1568	10/100
5731 73	Switch - 20 A-3 gang - 2x2 way + 1x1 way- 2 module	1654	10/100
5733 92	Switch 20 A-DP - 1 way with indicator - 2 module	1220	10/100
5731 27	Switch - 20 A-SP - 2 way with indicator - middle - 1 module	794	20/200

### Switches - 32A

5733 76	Switch - 32 A-DP - 1 way with indicator - 2 module	1766	10/100
---------	--	------	--------

### Push button - 6 A - 250 V AC

5733 81	Bell push - 6 A-SP - 1 way - right - 1 module	446	20/200
5733 80	Bell push - 6 A-SP - 1 way - left - 1 module	446	20/200
5733 96	Bell push - 6 A-SP- 1 way - 2 module	636	10/100
5733 59	Push button - 6 A-SP - 1 way - left - 1 module	468	20/200
5733 61	Push button - 6 A-SP - 1 way - right - 1 module	478	20/200
5733 97	Bell push - 6 A-SP - 1 way with indicator - 2 module	836	10/100
5733 60	Push button - 6 A-SP - 1 way - middle - 1 module	478	20/200

### Electronic roller blinds control

5737 20	Double pole switch 10 A - 2 module	1118	10/100
---------	------------------------------------	------	--------

### Dimmers and fan regulators

5733 66	Light dimmer - 60 to 400 watts - 2 module	1796	1/10/100
5731 03	Fan step regulator - 100 watts - 2 module	1806	1/10/100
5731 69	Fan step regulator - 120 watts - 2 module	1944	1/10/100
5731 04	Fan step regulator- 2 module for energy saving fans	1924	1/10/100

\* MRP - Maximum Retail Price Inclusive of all taxes including GST.  
Red Cat.Nos - new products  
■ Price available on request.

## Arteor™ round - magnesium mechanisms

Cat.Nos	Description	MRP* ₹ / Unit	Pack
---------	-------------	------------------	------

### Electronic dimmer

5743 39	Universal dimmer without neutral 400 W - 2 module	16024	1/10
---------	---	-------	------

### Multistandard sockets

5736 89	Multistandard socket 6/10/13 A - 2/3 pin for 250 V AC 15 A for 127 V type - 2 pin 2 module	668	10/100
---------	--	-----	--------

### USB chargers (IS13252 (Part 1) / IEC 60950-1)

5736 23	Double USB charger 2M 2400mA	3614	1/10/100
---------	------------------------------	------	----------

### Information outlets - toolless

5728 24	Information socket - category 6 - UTP - 2 module	1558	10/100
---------	--	------	--------

### Hotel internal control units

5725 74	Internal control unit for DND & MMR - 1+1 module	2388	5/50
5725 67	DND & MMR Indicator with bell push - 2 module	2856	5/40

### Audio-video sockets

5727 85	HDMI socket - 2 module	6944	1/20
5745 51	S-VIDEO socket - 2 module	4556	1/20

### Blanking plate

5731 87	2 modules blank	108	10/100
---------	-----------------	-----	--------

## Round - champagne mechanisms

### Switches - 6 A - 250 V AC

5749 00	Switch - 6 A-SP - 1 way - left - 1 module	346	20/200
5749 01	Switch - 6 A-SP - 1 way - right - 1 module	346	20/200
5749 02	Switch - 6 A-SP - 1 way - middle - 1 module	346	20/200
5749 03	Switch - 6 A-SP - 2 way - left - 1 module	424	20/200
5749 04	Switch - 6 A-SP - 2 way - right - 1 module	424	20/200
5749 05	Switch - 6 A-SP- 1 way with indicator - left - 1 module	468	20/200
5749 06	Switch - 6 A-SP - 1 way with indicator - right - 1 module	468	20/200
5749 07	Switch - 6 A-SP - 1 way with indicator - middle - 1 module	468	20/200
5749 08	Switch - 6 A-SP - 2 way with indicator - left - 1 module	606	20/200
5749 09	Switch - 6 A-SP - 2 way with indicator - right - 1 module	606	20/200

Bold Cat.Nos are products normally available with Legrand (India) Stockists. Cat.Nos that are not bold - delivery within 4 - 8 weeks from the date of order. Bold packing quantity is our mandatory packing. Orders to be placed by Legrand (India) Stockist in multiples of the same.



## Arteor™ round - champagne mechanisms

Cat.Nos	Description	MRP* ₹ / Unit	Pack
---------	-------------	------------------	------

### Switches - 20 A - 250 V AC

5749 10	Switch - 20 A-SP - 1 way - left - 1 module	544	20/200
5749 11	Switch - 20 A-SP - 1 way - right - 1 module	544	20/200
5749 12	Switch - 20 A-SP - 1 way - middle - 1 module	544	20/200
5749 13	Switch - 20 A-SP - 1 way - 2 module	646	10/100
5749 14	Switch - 20 A-SP - 1 way with indicator - left - 1 module	568	20/200
5749 15	Switch - 20 A-SP - 1 way with indicator - right - 1 module	568	20/200
5749 16	Switch - 20 A-SP - 2 way - middle - 1 module	578	20/200
5749 17	Switch - 20 A-SP - 2 way with indicator - left - 1 module	794	20/200
5749 18	Switch - 20 A-SP - 2 way with indicator - right - 1 module	794	20/200
5749 19	Switch - 20 A-SP - 2 way with indicator - 2 module	754	10/100
5749 20	Switch - 20 A-3 gang - 1 way - 2 module	1568	10/100
5749 21	Switch - 20 A-3 gang - 2x2 way + 1x1 way - 2 module	1654	10/100
5749 22	Switch 20 A-DP - 1 way with indicator - 2 module	1220	10/100

### Push button - 6 A - 250 V AC

5749 23	Bell push - 6 A-SP - 1 way - right - 1 module	446	20/200
5749 24	Bell push - 6 A-SP - 1 way - left - 1 module	446	20/200
5749 25	Bell push - 6 A-SP - 1 way - 2 module	636	10/100
5749 26	Bell push - 6 A-SP - 1 way with indicator - 2 module	836	10/100

### Dimmers and fan regulators

5749 27	Light dimmer - 60 to 400 watts - 2 module	1850	1/10/100
5749 29	Fan step regulator - 100 watts - 2 module	1806	1/10/100
5749 30	Fan step regulator - 120 watts - 2 module	1944	1/10/100
5749 31	Fan step regulator - 2 module for energy saving fans	1924	1/10/100

### Multistandard sockets

5749 40	Multistandard socket 6/10/13 A - 2/3 pin for 250 V AC 15 A for 127 V type - 2 pin 2 module	668	10/100
---------	--	-----	--------

### USB chargers (IS13252 (Part 1) / IEC 60950-1)

5749 44	Double USB charger 2M 2400mA	3614	1/10/100
---------	------------------------------	------	----------

### Blanking plate

5749 64	2 modules blank	108	10/100
---------	-----------------	-----	--------

\* MRP - Maximum Retail Price Inclusive of all taxes including GST.  
Red Cat.Nos - new products

## Arteor™ square cover plates

Cat.Nos	Description	MRP* ₹ / Unit	Pack
---------	-------------	------------------	------

### Square cover plates with Metal Frame White cover plates with Metal frame

5757 00	White plate - 1 module	236	10/100
5757 10	White plate - 2 module	250	10/100
5757 20	White plate - 3 module	276	10/100
5757 30	White plate - 4 module	290	5/50
5757 40	White plate - 6 module	528	5/30
5757 50	White plate - 8 module	590	5/30
5757 60	White plate - 2x4 module	742	2/20
5757 70	White plate - 2x6 module	908	2/16
5757 80	White plate - 2x8 module	1088	2/16
5757 90	White plate - 3x6 module	1202	2/12
5758 00	White plate - 3x8 module	1436	2/12
5750 70	White plate for shaver socket 3 module	412	5/50

### Pearl Aluminium cover plates with Metal frame

5759 73	Pearl Aluminium plate - 1 module	344	10/100
5759 74	Pearl Aluminium plate - 2 module	356	10/100
5759 75	Pearl Aluminium plate - 3 module	390	10/100
5759 76	Pearl Aluminium plate - 4 module	438	5/50
5759 77	Pearl Aluminium plate - 6 module	752	5/30
5759 78	Pearl Aluminium plate - 8 module	826	5/30
5759 79	Pearl Aluminium plate - 2x4 module	1050	2/20
5759 80	Pearl Aluminium plate - 2x6 module	1364	2/16
5759 81	Pearl Aluminium plate - 2x8 module	1544	2/16
5759 82	Pearl Aluminium plate - 3x6 module	1802	2/12
5759 83	Pearl Aluminium plate - 3x8 module	2058	2/12

### Graphite cover plates with Metal frame

5759 61	Graphite plate - 1 module	344	10/100
5759 62	Graphite plate - 2 module	356	10/100
5759 63	Graphite plate - 3 module	390	10/100
5759 64	Graphite plate - 4 module	438	5/50
5759 66	Graphite plate - 6 module	752	5/30
5759 67	Graphite plate - 8 module	826	5/30
5759 68	Graphite plate - 2x4 module	1050	2/20
5759 69	Graphite plate - 2x6 module	1364	2/16
5759 70	Graphite plate - 2x8 module	1544	2/16
5759 71	Graphite plate - 3x6 module	1802	2/12
5759 72	Graphite plate - 3x8 module	2058	2/12

### Magnesium cover plates with Metal frame

5755 89	Magnesium plate - 1 module	344	10/100
5755 90	Magnesium plate - 2 module	356	10/100
5755 91	Magnesium plate - 3 module	390	10/100
5755 93	Magnesium plate - 4 module	438	5/50
5755 94	Magnesium plate - 6 module	750	5/30
5755 95	Magnesium plate - 8 module	826	5/30
5755 96	Magnesium plate - 2x4 module	1050	2/20
5755 97	Magnesium plate - 2x6 module	1364	2/16
5755 98	Magnesium plate - 2x8 module	1544	2/16
5755 99	Magnesium plate - 3x6 module	1802	2/12

### Champagne cover plates with Metal frame

5759 84	Champagne plate - 1 module	344	10/100
5759 85	Champagne plate - 2 module	356	10/100
5759 86	Champagne plate - 3 module	390	10/100
5759 87	Champagne plate - 4 module	438	5/50

Bold Cat.Nos are products normally available with Legrand (India) Stockists.  
Cat.Nos that are not bold - delivery within 4 - 8 weeks from the date of order.  
Bold packing quantity is our mandatory packing. Orders to be placed by Legrand (India) Stockist in multiples of the same.



## Arteor™ square cover plates

Cat.Nos	Description	MRP* ₹ / Unit	Pack
---------	-------------	------------------	------

### Champagne cover plates with Metal frame

5759 88	Champagne plate - 6 module	750	5/30
5759 89	Champagne plate - 8 module	826	5/30
5759 90	Champagne plate - 2x4 module	1050	2/20
5759 91	Champagne plate - 2x6 module	1364	2/16
5759 92	Champagne plate - 2x8 module	1544	2/16
5759 93	Champagne plate - 3x6 module	1802	2/12

### Dark Bronze cover plates with Metal frame

5756 79	Dark Bronze plate - 1 module	344	10/100
5756 80	Dark Bronze plate - 2 module	356	10/100
5756 81	Dark Bronze plate - 3 module	390	10/100
5756 83	Dark Bronze plate - 4 module	438	5/50
5756 84	Dark Bronze plate - 6 module	750	5/30
5756 85	Dark Bronze plate - 8 module	826	5/30
5756 86	Dark Bronze plate - 2x4 module	1050	2/20
5756 87	Dark Bronze plate - 2x6 module	1364	2/16
575688	Dark Bronze plate - 2x8 module	1544	2/16
5756 89	Dark Bronze plate - 3x6 module	1802	2/12

### Pearl aluminium cover plates with Overmoulded frame

5757 01	Pearl aluminium plate - 1 module	382	10/100
5757 11	Pearl aluminium plate - 2 module	404	10/100
5757 21	Pearl aluminium plate - 3 module	430	10/100
5757 31	Pearl aluminium plate - 4 module	484	5/50
5757 41	Pearl aluminium plate - 6 module	828	5/30
5757 51	Pearl aluminium plate - 8 module	918	5/30
5757 61	Pearl aluminium plate - 2x4 module	1164	2/20
5757 71	Pearl aluminium plate - 2x6 module	1512	2/16
5757 81	Pearl aluminium plate - 2x8 module	1716	2/16
5757 91	Pearl aluminium plate - 3x6 module	2006	2/12
5758 01	Pearl aluminium plate - 3x8 module	2282	2/12
5750 71	Pearl aluminium plate for shaver socket 3 module	650	5/50

### Graphite cover plates with Overmoulded frame

5757 02	Graphite plate - 1 module	382	10/100
5757 12	Graphite plate - 2 module	404	10/100
5757 22	Graphite plate - 3 module	430	10/100
5757 32	Graphite plate - 4 module	484	5/50
5757 42	Graphite plate - 6 module	828	5/30
5757 52	Graphite plate - 8 module	918	5/30
5757 62	Graphite plate - 2x4 module	1164	2/20
5757 72	Graphite plate - 2x6 module	1512	2/16
5757 82	Graphite plate - 2x8 module	1716	2/16
5757 92	Graphite plate - 3x6 module	2006	2/12
5758 02	Graphite plate - 3x8 module	2282	2/12
5750 72	Graphite plate for shaver socket 3 module	650	5/50

## Arteor™ square cover plates

Cat.Nos	Description	MRP* ₹ / Unit	Pack
---------	-------------	------------------	------

### Magnesium cover plates with Overmoulded frame

5758 11	Magnesium plate - 1 module	382	10/100
5758 12	Magnesium plate - 2 module	404	10/100
5758 13	Magnesium plate - 3 module	430	10/100
5758 14	Magnesium plate - 4 module	484	5/50
5758 15	Magnesium plate - 6 module	828	5/30
5758 16	Magnesium plate - 8 module	918	5/30
5758 17	Magnesium plate - 2x4 module	1164	2/20
5758 18	Magnesium plate - 2x6 module	1512	2/16
5758 19	Magnesium plate - 2x8 module	1716	2/16
5758 20	Magnesium plate - 3x6 module	2006	2/12
5758 21	Magnesium plate for shaver socket 3 module	650	5/50

### Champagne cover plates with Overmoulded frame

5758 22	Champagne plate - 1 module	382	10/100
5758 23	Champagne plate - 2 module	404	10/100
5758 24	Champagne plate - 3 module	430	10/100
5758 25	Champagne plate - 4 module	484	5/50
5758 26	Champagne plate - 6 module	828	5/30
5758 27	Champagne plate - 8 module	918	5/30
5758 28	Champagne plate - 2x4 module	1164	2/20
5758 29	Champagne plate - 2x6 module	1512	2/16
5758 30	Champagne plate - 2x8 module	1716	2/16
5758 31	Champagne plate - 3x6 module	2006	2/12
5758 32	Champagne plate for shaver socket 3 module	650	5/50

### Dark Bronze cover plates with Overmoulded frame

5758 33	Dark Bronze plate - 1 module	382	10/100
5758 34	Dark Bronze plate - 2 module	404	10/100
5758 35	Dark Bronze plate - 3 module	430	10/100
5758 36	Dark Bronze plate - 4 module	484	5/50
5758 37	Dark Bronze plate - 6 module	828	5/30
5758 38	Dark Bronze plate - 8 module	918	5/30
5758 39	Dark Bronze plate - 2x4 module	1164	2/20
5758 40	Dark Bronze plate - 2x6 module	1512	2/16
5758 41	Dark Bronze plate - 2x8 module	1716	2/16
5758 42	Dark Bronze plate - 3x6 module	2006	2/12
5758 43	Dark Bronze plate for shaver socket 3 module	650	5/50

### Mirror finish cover plates with Overmoulded frame

5757 03	Mirror black plate - 1 module	1896	1/5/30
5757 13	Mirror black plate - 2 module	2026	1/5/30
5757 23	Mirror black plate - 3 module	2172	1/20
5757 33	Mirror black plate - 4 module	2308	1/20
5757 43	Mirror black plate - 6 module	4200	1/5
5757 53	Mirror black plate - 8 module	4624	1/5
5757 63	Mirror black plate - 2x4 module	5860	1/10
5757 73	Mirror black plate - 2x6 module	7206	1/8
5750 73	Mirror black plate for shaver socket 3 module	2920	1/5/50
5757 04	Mirror white plate - 1 module	1896	1/5/30
5757 14	Mirror white plate - 2 module	2026	1/5/30
5757 24	Mirror white plate - 3 module	2172	1/20
5757 34	Mirror white plate - 4 module	2308	1/20
5757 44	Mirror white plate - 6 module	4200	1/5
5757 54	Mirror white plate - 8 module	4624	1/5
5757 64	Mirror white plate - 2x4 module	5968	1/10
5757 74	Mirror white plate - 2x6 module	7206	1/8

\* MRP - Maximum Retail Price Inclusive of all taxes including GST.  
Red Cat.Nos - new products

Bold Cat.Nos are products normally available with Legrand (India) Stockists.  
Cat.Nos that are not bold - delivery within 4 - 8 weeks from the date of order.  
Bold packing quantity is our mandatory packing. Orders to be placed by Legrand (India) Stockist in multiples of the same.

## Arteor™ square cover plates

## Arteor™ square cover plates

Cat.Nos	Description	MRP* ₹ / Unit	Pack
---------	-------------	------------------	------

Cat.Nos	Description	MRP* ₹ / Unit	Pack
---------	-------------	------------------	------

### Mirror finish cover plates with Overmoulded frame

5750 74	Mirror white plate for shaver socket 3 module	2920	1/5/50
5758 44	Green Apple plate - 1 module	1896	1/5/30
5758 45	Green Apple plate - 2 module	2026	1/5/30
5758 46	Green Apple plate - 3 module	2172	1/20
5758 47	Green Apple plate - 4 module	2308	1/20
5758 48	Green Apple plate - 6 module	4200	1/5
5758 49	Green Apple plate - 8 module	4624	1/5
5758 50	Green Apple plate - 2x4 module	5966	1/10
5758 51	Green Apple plate - 2x6 module	7206	1/8
5758 52	Green Apple plate for shaver socket 3 module	3162	1/5/50

### Metal finish cover plates with Overmoulded frame

5761 60	Gold brass plate - for shaver socket 3 module	3974	1/5/50
5757 06	Stainless steel plate - 1 module	3088	1/5/30
5757 16	Stainless steel plate - 2 module	3306	1/5/30
5757 26	Stainless steel plate - 3 module	3554	1/20
5757 36	Stainless steel plate - 4 module	3772	1/20
5757 46	Stainless steel plate - 6 module	6864	1/5
5757 66	Stainless steel plate - 2x4 module	9544	1/10
5757 56	Stainless steel plate - 8 module	7548	1/5
5757 76	Stainless steel plate - 2x6 module	11760	1/8
5750 76	Stainless steel plate - for shaver socket 3 module	3974	1/5/50

### Graphic cover plates with Overmoulded frame

5762 91	Graphic casual plate - 1 module	2300	1/5/30
5763 11	Graphic casual plate - 2 module	2474	1/5/30
5763 31	Graphic casual plate - 3 module	2662	1/5/20
5763 51	Graphic casual plate - 4 module	2840	1/20
5763 81	Graphic casual plate - 6 module	5138	1/5
5764 01	Graphic casual plate - 8 module	5666	1/5
5758 89	Graphic casual plate - 2x4 module	7136	1/10
5758 90	Graphic casual plate - 2x6 module	8834	1/8
5761 61	Graphic casual for shaver socket 3 module	3568	1/5/50

### Wood cover plates with Overmoulded frame

5758 80	Grey Oak plate - 1 module	1810	1/5/30
5758 81	Grey Oak plate - 2 module	1918	1/5/30
5758 82	Grey Oak plate - 3 module	2370	1/20
5758 83	Grey Oak plate - 4 module	2624	1/20
5758 84	Grey Oak plate - 6 module	3904	1/5
5758 85	Grey Oak plate - 8 module	4692	1/5
5758 86	Grey Oak plate - 2x4 module	5570	1/10
5758 87	Grey Oak plate - 2x6 module	7464	1/8
5758 88	Grey Oak plate for shaver socket 3 module	2314	1/5/50

### Silver Baroque plates with Overmoulded frame

5758 53	Silver Baroque plate -1 module	2300	1/5/30
5758 54	Silver Baroque plate - 2 module	2474	1/5/30
5758 55	Silver Baroque plate - 3 module	2662	1/20
5758 56	Silver Baroque plate - 4 module	2840	1/20
5758 57	Silver Baroque plate - 6 module	5138	1/5
5758 58	Silver Baroque plate - 8 module	5666	1/5
5758 59	Silver Baroque plate - 2x4 module	7136	1/10
5758 60	Silver Baroque plate - 2x6 module	8834	1/8
5758 61	Silver Baroque plate for shaver socket 3 module	3634	1/5/50

### Signature cover plates with Overmoulded frame

5758 71	Cube plate - 1 module	5920	1/5/30
5758 72	Cube plate - 2 module	6028	1/5/30
5758 73	Cube plate - 3 module	6892	1/20
5758 74	Cube plate - 4 module	7122	1/20
5758 75	Cube plate - 6 module	9274	1/5
5758 76	Cube plate - 8 module	9736	1/5
5758 77	Cube plate - 2x4 module	14548	1/10
5758 78	Cube plate - 2x6 module	16116	1/8
5758 79	Cube plate for shaver socket 3 module	6610	1/5/50

### Dark Baroque plates with Overmoulded frame

5758 62	Dark Baroque plate - 1 module	2300	1/5/30
5758 63	Dark Baroque plate - 2 module	2474	1/5/30
5758 64	Dark Baroque plate - 3 module	2662	1/20
5758 65	Dark Baroque plate - 4 module	2840	1/20
5758 66	Dark Baroque plate - 6 module	5138	1/5
5758 67	Dark Baroque plate - 8 module	5666	1/5
5758 68	Dark Baroque plate - 2x4 module	7136	1/10
5758 69	Dark Baroque plate - 2x6 module	8834	1/8
5758 70	Dark Baroque plate for shaver socket 3 module	3634	1/5/50

### Round cover plates with Metal Frame

#### White cover plates with Metal frame

5759 00	White plate - 2 module	358	10/100
5759 10	White plate - 3 module	376	10/100
5759 20	White plate - 4 module	400	5/50
5759 30	White plate - 6 module	726	5/30
5765 80	White plate - 8 module	802	5/30
5759 40	White plate - 2x4 module	850	2/20
5759 50	White plate - 2x6 module	1238	2/16

#### Pearl Aluminium cover plates with Metal frame

5757 93	Pearl Aluminium plate - 2 module	468	10/100
5757 94	Pearl Aluminium plate - 3 module	508	10/100
5757 95	Pearl Aluminium plate - 4 module	572	5/50
5757 96	Pearl Aluminium plate - 6 module	976	5/30
5757 97	Pearl Aluminium plate - 8 module	1078	5/30
5757 98	Pearl Aluminium plate - 2x4 module	1362	2/20
5757 99	Pearl Aluminium plate - 2x6 module	1776	2/16

### Metal finish cover plates with Overmoulded frame

5762 90	Gold brass plate - 1 module	3088	1/5/30
5763 10	Gold brass plate - 2 module	3306	1/5/30
5763 30	Gold brass plate -3 module	3554	1/20
5763 50	Gold brass plate - 4 module	3772	1/20
5763 80	Gold brass plate - 6 module	6864	1/5
5764 00	Gold brass plate - 8 module	7548	1/5

### Graphite cover plates with Metal frame

5758 03	Graphite plate - 2 module	468	10/100
5758 04	Graphite plate - 3 module	508	10/100

\* MRP - Maximum Retail Price Inclusive of all taxes including GST.  
Red Cat.Nos - new products

Bold Cat.Nos are products normally available with Legrand (India) Stockists.  
Cat.Nos that are not bold - delivery within 4 - 8 weeks from the date of order.  
Bold packing quantity is our mandatory packing. Orders to be placed by Legrand (India) Stockist in multiples of the same.

## Arteor™ round cover plates

Cat.Nos	Description	MRP* ₹ / Unit	Pack
---------	-------------	------------------	------

### Graphite cover plates with Metal frame

5758 05	Graphite plate - 4 module	572	5/50
5758 06	Graphite plate - 6 module	976	5/30
5758 07	Graphite plate - 8 module	1078	5/30
5758 08	Graphite plate - 2x4 module	1362	2/20
5758 09	Graphite plate - 2x6 module	1776	2/16

### Magnesium cover plates with Metal frame

5756 23	Magnesium plate - 2 module	468	10/100
5756 24	Magnesium plate - 3 module	508	10/100
5756 25	Magnesium plate - 4 module	570	5/50
5756 26	Magnesium plate - 6 module	972	5/30
5756 27	Magnesium plate - 8 module	1078	5/30
5756 28	Magnesium plate - 2x4 module	1362	2/20
5756 29	Magnesium plate - 2x6 module	1776	2/16

### Champagne cover plates with Metal frame

5758 91	Champagne plate - 2 module	468	10/100
5758 92	Champagne plate - 3 module	508	10/100
5758 93	Champagne plate - 4 module	570	5/50
5758 94	Champagne plate - 6 module	972	5/30
5758 95	Champagne plate - 8 module	1078	5/30
5758 96	Champagne plate - 2x4 module	1362	2/20
5758 97	Champagne plate - 2x6 module	1776	2/16

### Dark Bronze cover plates with Metal frame

5756 93	Dark Bronze plate - 2 module	468	10/100
5756 94	Dark Bronze plate - 3 module	508	10/100
5756 95	Dark Bronze plate - 4 module	570	5/50
5756 96	Dark Bronze plate - 6 module	972	5/30
5756 97	Dark Bronze plate - 8 module	1078	5/30
5756 98	Dark Bronze plate - 2x4 module	1362	2/20
5756 99	Dark Bronze plate - 2x6 module	1776	2/16

### Pearl aluminium cover plates with Overmoulded frame

5759 01	Pearl aluminium plate - 2 module	534	10/100
5759 11	Pearl aluminium plate - 3 module	560	10/100
5759 21	Pearl aluminium plate - 4 module	594	5/50
5759 31	Pearl aluminium plate - 6 module	1078	5/30
5765 81	Pearl aluminium plate - 8 module	1186	5/30
5759 41	Pearl aluminium plate - 2x4 module	1246	2/20
5759 51	Pearl aluminium plate - 2x6 module	1844	2/16

### Graphite cover plates with Overmoulded frame

5759 02	Graphite plate - 2 module	534	10/100
5759 12	Graphite plate - 3 module	560	10/100
5759 22	Graphite plate - 4 module	594	5/50
5759 32	Graphite plate - 6 module	1078	5/30
5765 82	Graphite plate - 8 module	1186	5/30
5759 42	Graphite plate - 2x4 module	1246	2/20
5759 52	Graphite plate - 2x6 module	1844	2/16

### Magnesium cover plates with Overmoulded frame

5768 41	Magnesium plate - 2 module	534	10/100
5768 42	Magnesium plate - 3 module	560	10/100
5768 43	Magnesium plate - 4 module	596	5/50
5768 44	Magnesium plate - 6 module	1078	5/30
5768 45	Magnesium plate - 8 module	1186	5/30
5768 46	Magnesium plate - 2x4 module	1246	2/20

\* MRP - Maximum Retail Price Inclusive of all taxes including GST.  
Red Cat.Nos - new products

## Arteor™ square cover plates

Cat.Nos	Description	MRP* ₹ / Unit	Pack
---------	-------------	------------------	------

### Magnesium cover plates with Overmoulded frame

5768 47	Magnesium plate - 2x6 module	1842	2/16
---------	------------------------------	------	------

### Champagne cover plates with Overmoulded frame

5768 48	Champagne plate - 2 module	534	10/100
5768 49	Champagne plate - 3 module	560	10/100
5768 50	Champagne plate - 4 module	596	5/50
5768 51	Champagne plate - 6 module	1078	5/30
5768 52	Champagne plate - 8 module	1186	5/30
5768 53	Champagne plate - 2x4 module	1246	2/20
5768 54	Champagne plate - 2x6 module	1842	2/16

### Dark Bronze cover plates with Overmoulded frame

5768 55	Dark Bronze plate - 2 module	534	10/100
5768 56	Dark Bronze plate - 3 module	560	10/100
5768 57	Dark Bronze plate - 4 module	596	5/50
5768 58	Dark Bronze plate - 6 module	1078	5/30
5768 59	Dark Bronze plate - 8 module	1186	5/30
5768 60	Dark Bronze plate - 2x4 module	1246	2/20
5768 61	Dark Bronze plate - 2x6 module	1842	2/16

### Mirror finish cover plates with Overmoulded frame

5759 03	Mirror black plate - 2 module	2238	1/5/30
5759 13	Mirror black plate - 3 module	2396	1/20
5759 23	Mirror black plate - 4 module	2546	1/20
5759 33	Mirror black plate - 6 module	4608	1/5
5765 83	Mirror black plate - 8 module	5094	1/5
5759 43	Mirror black plate - 2x4 module	6004	1/10
5759 53	Mirror black plate - 2x6 module	7938	1/8
5759 04	Mirror white plate - 2 module	2238	1/5/30
5759 14	Mirror white plate - 3 module	2396	1/20
5759 24	Mirror white plate - 4 module	2546	1/20
5759 34	Mirror white plate - 6 module	4608	1/5
5765 84	Mirror white plate - 8 module	5094	1/5
5759 44	Mirror white plate - 2x4 module	6130	1/10
5759 54	Mirror white plate - 2x6 module	7938	1/8
5768 62	Green Apple plate - 2 module	2238	1/5/30
5768 63	Green Apple plate - 3 module	2396	1/20
5768 64	Green Apple plate - 4 module	2546	1/20
5768 65	Green Apple plate - 6 module	4608	1/5
5768 66	Green Apple plate - 8 module	5094	1/5
5768 67	Green Apple plate - 2x4 module	6130	1/10
5768 68	Green Apple plate - 2x6 module	7938	1/8

### Graphic cover plates with overmoulded frames

5763 01	Graphic casual plate - 2 module	2730	1/5/30
5763 21	Graphic casual plate - 3 module	2922	1/20
5763 41	Graphic casual plate - 4 module	3118	1/20
5763 61	Graphic casual plate - 6 module	5656	1/5
5763 91	Graphic casual plate - 8 module	6226	1/5
5768 97	Graphic casual plate - 2x4 module	7472	1/10
5768 98	Graphic casual plate - 2x6 module	9716	1/8

### Round cover plates

#### Silver Baroque cover plates with Overmoulded frame

5768 69	Silver Baroque plate - 2 module	2730	1/5/30
---------	---------------------------------	------	--------

Bold Cat.Nos are products normally available with Legrand (India) Stockists.  
Cat.Nos that are not bold - delivery within 4 - 8 weeks from the date of order.  
Bold packing quantity is our mandatory packing. Orders to be placed by Legrand (India) Stockist in multiples of the same.



## Arteor™ round cover plates

Cat.Nos	Description	MRP* ₹ / Unit	Pack
---------	-------------	------------------	------

### Round cover plates Silver Baroque cover plates with Overmoulded frame

5768 70	Silver Baroque plate - 3 module	2922	1/20
5768 71	Silver Baroque plate - 4 module	3118	1/20
5768 72	Silver Baroque plate - 6 module	5656	1/5
5768 73	Silver Baroque plate - 8 module	6226	1/5
5768 74	Silver Baroque plate - 2x4 module	7472	1/10
5768 75	Silver Baroque plate - 2x6 module	9716	1/8

### Dark Baroque cover plates with Overmoulded frame

5768 76	Dark Baroque plate - 2 module	2730	1/5/30
5768 77	Dark Baroque plate - 3 module	2922	1/20
5768 78	Dark Baroque plate - 4 module	3118	1/20
5768 79	Dark Baroque plate - 6 module	5656	1/5
5768 80	Dark Baroque plate - 8 module	6226	1/5
5768 81	Dark Baroque plate - 2x4 module	7472	1/10
5768 82	Dark Baroque plate - 2x6 module	9716	1/8

### Metal finish cover plates with Overmoulded frame

5763 00	Gold brass plate - 2 module	3644	1/5/30
5763 20	Gold brass plate - 3 module	3894	1/20
5763 40	Gold brass plate - 4 module	4150	1/20
5763 60	Gold brass plate - 6 module	7540	1/5
5763 90	Gold brass plate - 8 module	8308	1/5
5759 06	Stainless steel plate - 2 module	3644	1/5/30
5759 16	Stainless steel plate - 3 module	3894	1/20
5759 26	Stainless steel plate - 4 module	4150	1/20
5759 36	Stainless steel plate - 6 module	7540	1/5
5765 86	Stainless steel plate - 8 module	8308	1/5
5759 46	Stainless steel plate - 2x4 module	10508	1/10
5759 56	Stainless steel plate - 2x6 module	12930	1/8

### Wood cover plates with Overmoulded frame

5768 90	Grey Oak plate - 2 module	1918	1/5/30
5768 91	Grey Oak plate - 3 module	2836	1/20
5768 92	Grey Oak plate - 4 module	2940	1/20
5768 93	Grey Oak plate - 6 module	4178	1/5
5768 94	Grey Oak plate - 8 module	5090	1/5
5768 95	Grey Oak plate - 2x4 module	5438	1/10
5768 96	Grey Oak plate - 2x6 module	6962	1/8

### Signature cover plates with Overmoulded frame

5768 83	Cube plate - 2 module	6028	1/5/30
5768 84	Cube plate - 3 module	7326	1/20
5768 85	Cube plate - 4 module	7460	1/20
5768 86	Cube plate - 6 module	9550	1/5
5768 87	Cube plate - 8 module	10130	1/5
5768 88	Cube plate - 2x4 module	14090	1/10
5768 89	Cube plate - 2x6 module	15946	1/8

\* MRP - Maximum Retail Price Inclusive of all taxes including GST.  
Red Cat.Nos - new products

## Arteor™ round cover plates

Cat.Nos	Description	MRP* ₹ / Unit	Pack
---------	-------------	------------------	------

### Accessories

#### Plastic surface boxes

5734 91	Surface box - 1/2 module	128	10/50
5735 20	Surface box - 3 module	154	5/35
5735 70	Surface box - 4 module	186	5/25
5735 71	Surface box - 6 module	230	1/10
5723 94	Surface box - 8 module	258	1/10
5735 74	Surface box - 2x4 module	316	2/10
5735 72	Surface box - 12/16 module	806	2/10
5735 73	Surface box - 18/24 module	856	2/8

#### Metal flush boxes

6890 07	Metal flush mounting Box - 1/2 module	138	40
6890 08	Metal flush mounting Box - 3 module	138	40
6890 09	Metal flush mounting Box - 4 module	184	40
6890 10	Metal flush mounting Box - 6 module	288	40
6890 42	Metal flush mounting Box - 8 module	338	40
6890 31	Metal flush mounting Box - 4x2 module	336	20
6890 11	Metal flush mounting Box - 12 / 16 module	508	10
6890 12	Metal flush mounting Box - 18 / 24 module	640	10

#### IP 55 Plexo box and accessories

0696 51	Grey Plexo box for 2 module	326	10/100
0696 72	Grey Plexo box for 2 x 2 module use two nos. of 0695 80	1062	5/50
0696 80	Grey Plexo box for 2 x 2 x 2 module use two nos. of 0695 80	1428	5/25
0696 89	White Plexo box for 2 module	398	10/100

#### IP 55 Plexo box and accessories

0695 80	Grey/White adaptor for IP 55 Plexo with smoked polycarbonate flap for 2 modules	1222	10/100
6846 38	Grey Plexo box & adaptor with transparent flap for 3 modules, IP 66	4884	1

#### IP 55 Plexo box with PVC membrane

6806 11	Grey Plexo box & adaptor with PVC membrane - 1 module	1076	10
6806 12	Grey Plexo box & adaptor with PVC membrane - module	1102	10
6806 13	Grey Plexo box & adaptor with PVC membrane - module	1466	10
6806 14	Grey Plexo box & adaptor with PVC membrane - 4 module	2198	5
6806 19	Grey Plexo box & adaptor with PVC membrane - 2 row x 4 module	3564	5
6806 33	Grey Plexo flush adaptor with membrane for 3 module Arteor™ box	1172	20



5735 70



6890 07



6890 08



6890 09



6890 10



0695 80



6846 38



6806 12



6806 13



6806 19



6806 19



6806 33

Bold Cat.Nos are products normally available with Legrand (India) Stockists. Cat.Nos that are not bold - delivery within 4 - 8 weeks from the date of order. Bold packing quantity is our mandatory packing. Orders to be placed by Legrand (India) Stockist in multiples of the same.

# ARTEOR™ IoT

## ADD A TOUCH OF SMARTNESS

### THE SMART RADIO SOLUTION

Arteor IoT offer, a radio-based solution for the connected home. The intelligent products communicate with one another via radio ZigBee 3.0 (2.4 GHz waveband). This means there is no need for specific or extensive cabling. Also, although the range only contains a few products, these can be used to create lots of individual solutions for a more customized feel at home.

### SIMPLE, ADAPTABLE, OPEN

Radio-based Arteor has been designed and developed as a simple solution to make every house more individual, convenient and secure. Simple for planners, who are able to integrate many useful functions without having to provide for complicated cabling. Simple for installers, who are able to install the system without a great deal of effort or specialist knowledge. Simple for users, who will find it convenient to operate, easy to extend and are able to make changes at any time.



### THE HOME + CONTROL APP FOR SMARTPHONE OR TABLET

The app on the smartphone or tablet opens up new options: monitoring of instantaneous power consumption, remote surveillance of the connected home, and control over various functions when the user is out and about.



Scan to know more about  
the product.



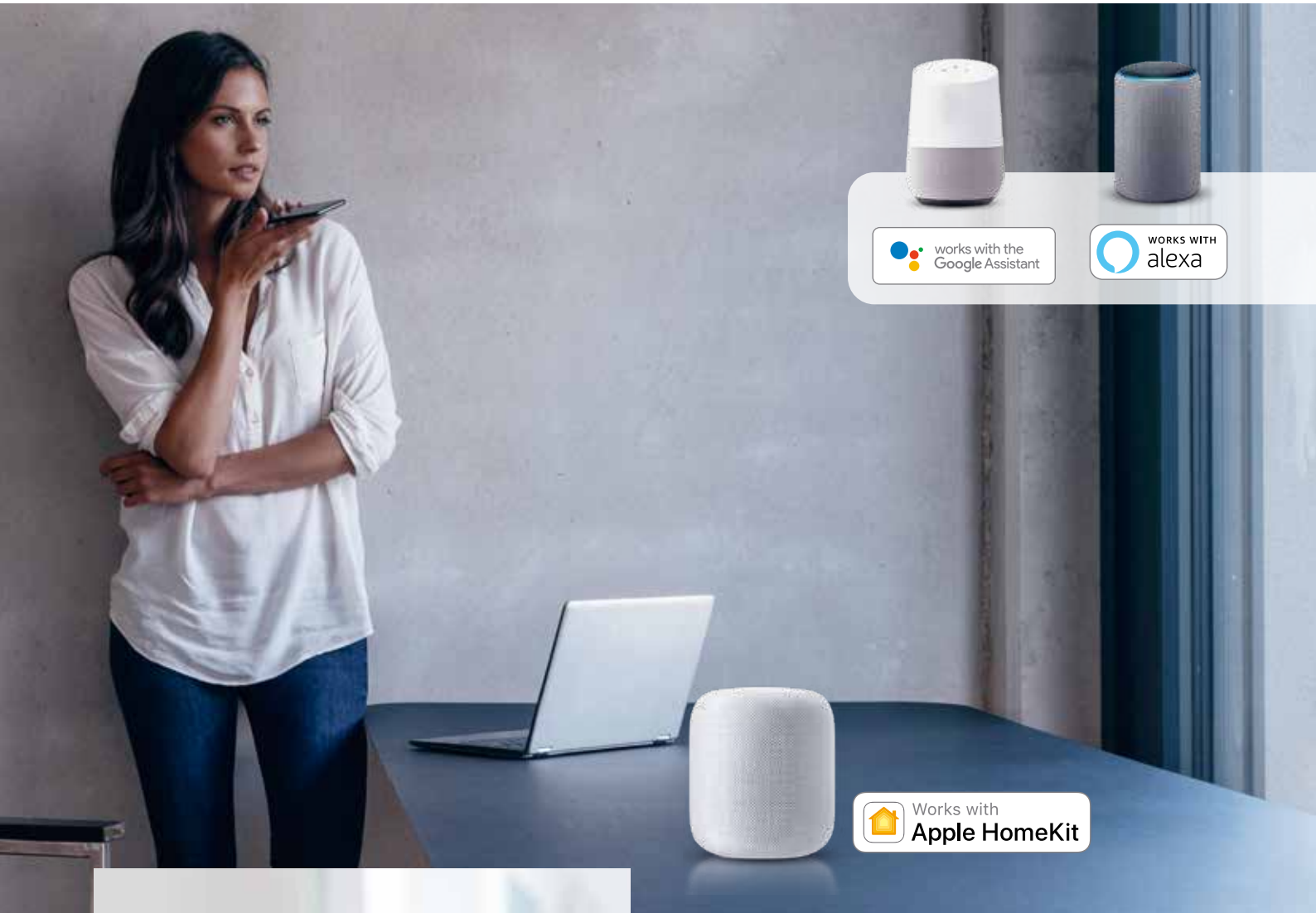

## LOCAL CONTROL GUARANTEED

Of course, all functions can still be used in the traditional way via switches on the wall. If furniture needs to be rearranged or small children need to be able to reach a switch, the wireless switches can be repositioned easily at any time.



**Home + Control App**

iPhone, iPod and iPad are registered trademarks of Apple Inc., registered in the US and other countries. HomeKit is a trademark of Apple Inc. App store is a service mark of Apple Inc., Google, Android, Google Play, and the Google Play logo are trademarks of Google LLC. Amazon, Alexa and all related logos are trademarks of Amazon.com, Inc. or its affiliates.

# ARTEOR™

SMART HOMES,  
SMARTER  
CONVENIENCE!

**COMPACT & THOUGHTFUL FOR  
ENHANCED CONVENIENCE!**

At Legrand, it our promise to enhance convenience at every point of interaction. The process of designeering that we follow ensures the best of fusion between the design and engineering. Arteor range launched in 2019, has witness huge success due to its unique style and unmatched range of functions. Further raising the bar, Arteor IoT range is enhanced with 6 new products, to ensure that you live the advantage.



**DIMMER WITH  
NEUTRAL 1M 150W**



**4 SCENARIO CONTROL  
WIRELESS SW**



**WIRELESS  
2 GANG SWITCH**

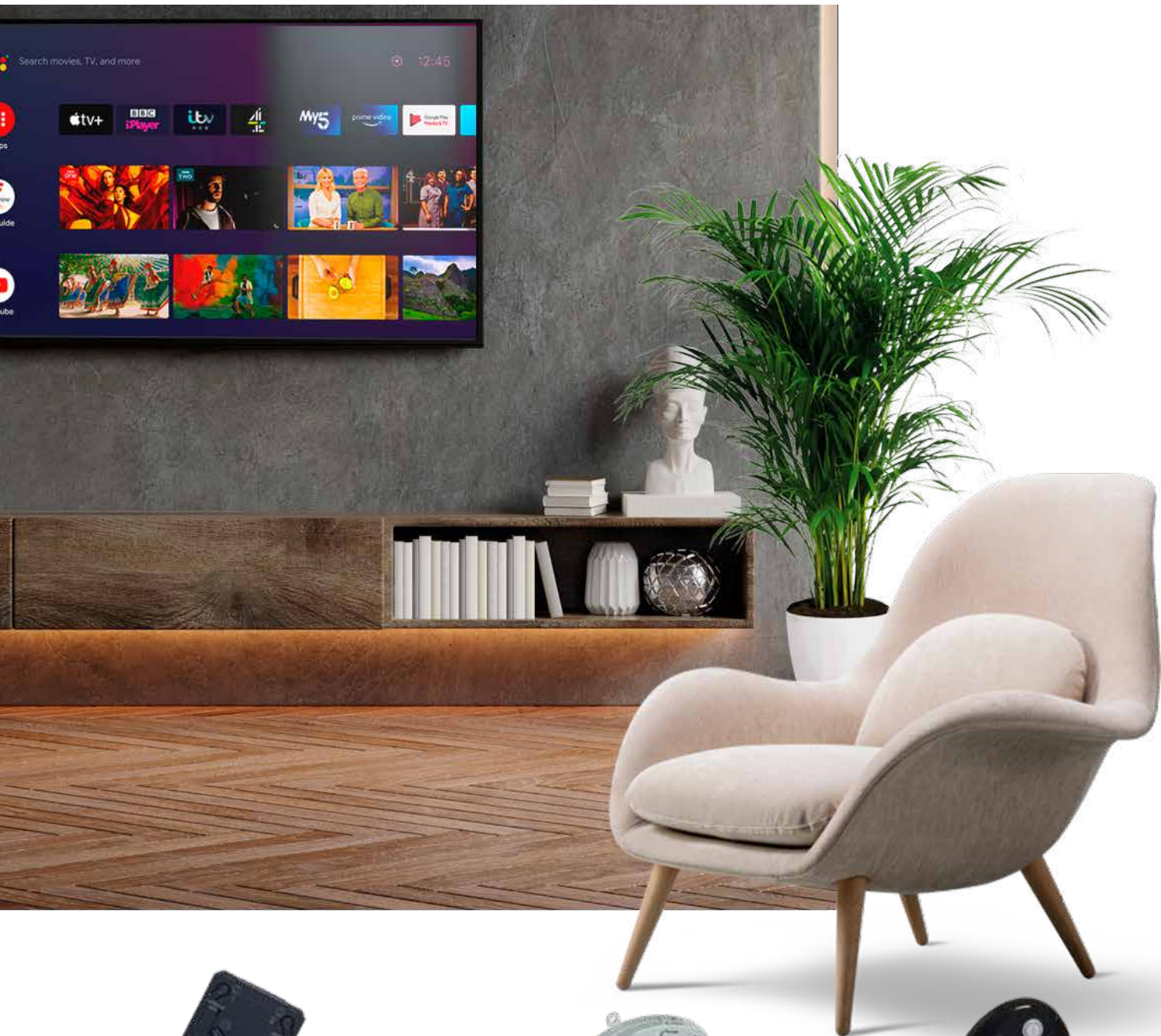

**AUXILIARY WIRELESS SWITCH**



**SHUTTER MICRO MODULE**



**PORTABLE REMOTE**



# CX<sup>3</sup>

## ADDING COMFORT IS SIMPLICITY ITSELF

With our smart electrical panel solutions and the Home + Control app, you have the benefit of a complete system for controlling your electrical installation on any type of site, from private houses to large blocks of flats.



GATEWAY MODULE





SMART CONTACTOR



SMART LATCHING RELAY



SMART ECOMETER



ENERGY METER



SMART LOAD SHEDDER



Voice Control



Ease of Scheduling



Smart Energy Management



## Arteor™

### Connected Home - white mechanism

Cat.Nos	Description	MRP* ₹ / Unit	Pack
---------	-------------	------------------	------

#### Connected light switches

5742 01	Switch with neutral, wired, 1 module	8950	1/24
5742 02	Switch without neutral, with dimmer option, wired, 2 modules	15052	1/12
574340	Switch dimmer with neutral 150w, 1 mod	9984	1

#### Connected outlets

5742 00	Connected socket outlet module - 16A - 240VA - 3680 W, 1 module	10498	1/12
---------	---	-------	------

#### Connected curtain/roller blind switches

5742 04	Connected curtain/roller blind switch wired, 1 module	11098	1/24
---------	---	-------	------

#### Connected gateway pack

5742 09	Connected gateway + Master home away wireless switch wired, 2 module	22338	1/4
---------	--	-------	-----

#### Connected wireless controls

5742 05	Wireless light switch	4786	1/10
5742 44	2G wireless switch	5512	1
5742 07	Curtain/roller blind wireless switch	5518	1/10

#### Connected wireless scene switches

5742 06	Home/Away wireless master switch	5518	1/10
5742 08	Wake up/Sleep wireless switch	5518	1/10
574312	Wireless 4 scenes switch	6890	1

#### Magnesium Mechanism connected light switches

5742 20	Switch with neutral, wired, 1 module	10296	1/24
5742 21	Switch without neutral, with dimmer option, wired, 2 modules	17308	1/12
574342	Switch Dimmer With Neutral 150w, 1 Mod	11482	1

#### Connected outlets

5742 28	Connected socket outlet module - 16A - 240VA - 3680 W, 1 module	12076	1/12
---------	---	-------	------

#### Connected curtain/roller blind switches

5742 22	Connected curtain/roller blind switch wired, 1 module	12758	1/24
---------	---	-------	------

#### Connected gateway pack

5742 27	Connected gateway + Master home away wireless switch wired, 2 module	25682	1/4
---------	--	-------	-----

\* MRP - Maximum Retail Price Inclusive of all taxes including GST.  
 # To be Introduced Shortly  
 (1) Supplied with white plate  
 ■ Price available on request



5742 01



5742 00



5742 04



5742 09



5742 07



5742 06



5742 20



5742 28



5742 22



5742 27

## Arteor™

### Connected Home - white mechanism

Cat.Nos	Description	MRP* ₹ / Unit	Pack
---------	-------------	------------------	------

#### Connected wireless controls

5742 23	Wireless light switch - 1-gang	5506	1/10
5742 46	2G wireless switch	6338	1
5742 25	Curtain/roller blind wireless switch	6348	1/10

#### Connected wireless scene switches

5742 24	Home/Away wireless master switch	6348	1/10
5742 26	Wake up/Sleep wireless switch	6348	1/10
5743 14	Wireless 4 scenes switch	7926	1

#### Champagne Mechanism Connected light switches

5742 29	Switch with neutral, wired, 1 module	10296	1/24
5742 30	Switch without neutral, with dimmer option, wired, 2 modules	17308	1/12
5743 43	Switch dimmer with neutral 150w, 1 mod	11482	1

#### Connected outlets

5742 37	Connected socket outlet module - 16A - 240VA - 3680 W, 1 module	12076	1/12
---------	---	-------	------

#### Connected curtain/roller blind switches

5742 31	Connected curtain/roller blind switch wired, 1 module	12758	1/24
---------	---	-------	------

#### Connected gateway pack

5742 36	Connected gateway + Master home away wireless switch wired, 2 module	25682	1/4
---------	--	-------	-----

#### Connected wireless controls

5742 32	Wireless light switch - 1-gang	5506	1/10
5742 47	2G wireless switch	6338	1
5742 34	Curtain/roller blind wireless switch	6348	1/10

#### Connected wireless scene switches

5742 33	Home/Away wireless master switch	6348	1/10
5742 35	Wake up/Sleep wireless switch	6348	1/10
5743 15	Wireless 4 scenes switch	7926	1

#### Micro module switch

5742 43	Micro module switch with neutral, 300 W	7788	1/24
0676 97	Shutter micromodule	10106	1
0676 94	Wireless switch on/off module for mechanical switch (auxiliary)	9360	1
0676 95	Portable remote	12462	1



5742 23



5742 24



5742 26



5742 29



5742 30



5742 31



5742 36



5742 34



5742 35

Bold Cat.Nos are products normally available with Legrand (India) Stockists. Cat.Nos that are not bold - delivery within 4 - 8 weeks from the date of order. Bold packing quantity is our mandatory packing. Orders to be placed by Legrand (India) Stockist in multiples of the same.

## Arteor™ cover plates

Cat.Nos	Description	MRP* ₹ / Unit	Pack
---------	-------------	------------------	------

### COVER PLATES

#### White cover plates with Overmoulded frame

5758 98	White plate - 1 module	322	10/100
5758 99	White plate - 2 module	334	10/100
5759 60	White plate - 3 module	390	10/100
5759 65	White plate - 4 module	446	5/50
5759 94	White plate - 6 module	610	5/30
5759 95	White plate - 8 module	720	5/30
5759 96	White plate - 2x4 module	1056	2/20
5759 97	White plate - 2x6 module	1404	2/16
5759 98	White plate - 2x8 module	1542	2/16
5759 99	White plate - 3x6 module	1818	2/12

#### Pearl aluminium cover plates with Overmoulded frame

5757 01	Pearl aluminium plate - 1 module	382	10/100
5757 11	Pearl aluminium plate - 2 module	404	10/100
5757 21	Pearl aluminium plate - 3 module	430	10/100
5757 31	Pearl aluminium plate - 4 module	484	5/50
5757 41	Pearl aluminium plate - 6 module	828	5/30
5757 51	Pearl aluminium plate - 8 module	918	5/30
5757 61	Pearl aluminium plate - 2x4 module	1164	2/20
5757 71	Pearl aluminium plate - 2x6 module	1512	2/16
5757 81	Pearl aluminium plate - 2x8 module	1716	2/16
5757 91	Pearl aluminium plate - 3x6 module	2006	2/12

#### Graphite cover plates with Overmoulded frame

5757 02	Graphite plate - 1 module	382	10/100
5757 12	Graphite plate - 2 module	404	10/100
5757 22	Graphite plate - 3 module	430	10/100
5757 32	Graphite plate - 4 module	484	5/50
5757 42	Graphite plate - 6 module	828	5/30
5757 52	Graphite plate - 8 module	918	5/30
5757 62	Graphite plate - 2x4 module	1164	2/20
5757 72	Graphite plate - 2x6 module	1512	2/16
5757 82	Graphite plate - 2x8 module	1716	2/16
5757 92	Graphite plate - 3x6 module	2006	2/12

\* MRP - Maximum Retail Price Inclusive of all taxes including GST.

■ To be Introduced Shortly

(1) Supplied with white plate

■ Price available on request

## Arteor™ cover plates

Cat.Nos	Description	MRP* ₹ / Unit	Pack
---------	-------------	------------------	------

### Magnesium cover plates with Overmoulded frame

5758 11	Magnesium plate - 1 module	382	10/100
5758 12	Magnesium plate - 2 module	404	10/100
5758 13	Magnesium plate - 3 module	430	10/100
5758 14	Magnesium plate - 4 module	484	5/50
5758 15	Magnesium plate - 6 module	828	5/30
5758 16	Magnesium plate - 8 module	918	5/30
5758 17	Magnesium plate - 2x4 module	1164	2/20
5758 18	Magnesium plate - 2x6 module	1512	2/16
5758 19	Magnesium plate - 2x8 module	1716	2/16
5758 20	Magnesium plate - 3x6 module	2006	2/12

### Champagne cover plates with Overmoulded frame

5758 22	Champagne plate - 1 module	382	10/100
5758 23	Champagne plate - 2 module	404	10/100
5758 24	Champagne plate - 3 module	430	10/100
5758 25	Champagne plate - 4 module	484	5/50
5758 26	Champagne plate - 6 module	828	5/30
5758 27	Champagne plate - 8 module	918	5/30
5758 28	Champagne plate - 2x4 module	1164	2/20
5758 29	Champagne plate - 2x6 module	1512	2/16
5758 30	Champagne plate - 2x8 module	1716	2/16
5758 31	Champagne plate - 3x6 module	2006	2/12

### Dark Bronze cover plates with Overmoulded frame

5758 33	Dark Bronze plate - 1 module	382	10/100
5758 34	Dark Bronze plate - 2 module	404	10/100
5758 35	Dark Bronze plate - 3 module	430	10/100

Bold Cat.Nos are products normally available with Legrand (India) Stockists. Cat.Nos that are not bold - delivery within 4 - 8 weeks from the date of order. Bold packing quantity is our mandatory packing. Orders to be placed by Legrand (India) Stockist in multiples of the same.

## Arteor™ square - white mechanisms

Cat.Nos	Description	MRP* ₹ / Unit	Pack
---------	-------------	------------------	------

### Dark Bronze cover plates with Overmoulded frame

5758 36	Dark Bronze plate - 4 module	484	5/50
5758 37	Dark Bronze plate - 6 module	828	5/30
5758 38	Dark Bronze plate - 8 module	918	5/30
5758 39	Dark Bronze plate - 2x4 module	1164	2/20
5758 40	Dark Bronze plate - 2x6 module	1512	2/16
5758 41	Dark Bronze plate - 2x8 module	1716	2/16
5758 42	Dark Bronze plate - 3x6 module	2006	2/12

### Mirror finish cover plates with Overmoulded frame

5757 03	Mirror black plate - 1 module	1896	1/5/30
5757 13	Mirror black plate - 2 module	2026	1/5/30
5757 23	Mirror black plate - 3 module	2172	1/20
5757 33	Mirror black plate - 4 module	2308	1/20
5757 43	Mirror black plate - 6 module	4200	1/5
5757 53	Mirror black plate - 8 module	4624	1/5
5757 63	Mirror black plate - 2x4 module	5860	1/10
5757 73	Mirror black plate - 2x6 module	7206	1/8
5757 04	Mirror white plate - 1 module	1896	1/5/30
5757 14	Mirror white plate - 2 module	2026	1/5/30
5757 24	Mirror white plate - 3 module	2172	1/20
5757 34	Mirror white plate - 4 module	2308	1/20
5757 44	Mirror white plate - 6 module	4200	1/5
5757 54	Mirror white plate - 8 module	4624	1/5
5757 64	Mirror white plate - 2x4 module	5968	1/10
5757 74	Mirror white plate - 2x6 module	7206	1/8

## Arteor™ square - white mechanisms

Cat.Nos	Description	MRP* ₹ / Unit	Pack
---------	-------------	------------------	------

### Mirror finish cover plates with Overmoulded frame

5758 44	Green Apple plate - 1 module	1896	1/5/30
5758 45	Green Apple plate - 2 module	2026	1/5/30
5758 46	Green Apple plate - 3 module	2172	1/20
5758 47	Green Apple plate - 4 module	2308	1/20
5758 48	Green Apple plate - 6 module	4200	1/5
5758 49	Green Apple plate - 8 module	4624	1/5
5758 50	Green Apple plate - 2x4 module	5966	1/10
5758 51	Green Apple plate - 2x6 module	7206	1/8

### Graphic cover plates with Overmoulded frame

5762 91	Graphic casual plate - 1 module	2300	1/5/30
5763 11	Graphic casual plate - 2 module	2474	1/5/30
5763 31	Graphic casual plate - 3 module	2662	1/5/20
5763 51	Graphic casual plate - 4 module	2840	1/20
5763 81	Graphic casual plate - 6 module	5138	1/5
5764 01	Graphic casual plate - 8 module	5666	1/5
5758 89	Graphic casual plate - 2x4 module	7136	1/10
5758 90	Graphic casual plate - 2x6 module	8834	1/8

### Silver Baroque plates with Overmoulded frame

5758 53	Silver Baroque plate - 1 module	2300	1/5/30
5758 54	Silver Baroque plate - 2 module	2474	1/5/30
5758 55	Silver Baroque plate - 3 module	2662	1/20
5758 56	Silver Baroque plate - 4 module	2840	1/20
5758 57	Silver Baroque plate - 6 module	5138	1/5
5758 58	Silver Baroque plate - 8 module	5666	1/5
5758 59	Silver Baroque plate - 2x4 module	7136	1/10

\* MRP - Maximum Retail Price Inclusive of all taxes including GST.  
 # To be Introduced Shortly  
 (1) Supplied with white plate  
 ■ Price available on request

Bold Cat.Nos are products normally available with Legrand (India) Stockists.  
 Cat.Nos that are not bold - delivery within 4 - 8 weeks from the date of order.  
 Bold packing quantity is our mandatory packing. Orders to be placed by Legrand (India) Stockist in multiples of the same.

## Arteor™ square - white mechanisms

Cat.Nos	Description	MRP* ₹ / Unit	Pack
---------	-------------	------------------	------

### Silver Baroque plates with Overmoulded frame

5758 60	Silver Baroque plate - 2x6 module	8834	1/8
---------	-----------------------------------	------	-----

### Dark Baroque plates with Overmoulded frame

5758 62	Dark Baroque plate - 1 module	2300	1/5/30
5758 63	Dark Baroque plate - 2 module	2474	1/5/30
5758 64	Dark Baroque plate - 3 module	2662	1/20
5758 65	Dark Baroque plate - 4 module	2840	1/20
5758 66	Dark Baroque plate - 6 module	5138	1/5
5758 67	Dark Baroque plate - 8 module	5666	1/5
5758 68	Dark Baroque plate - 2x4 module	7136	1/10
5758 69	Dark Baroque plate - 2x6 module	8834	1/8

### Metal finish cover plates with Overmoulded frame

5762 90	Gold brass plate - 1 module	3088	1/5/30
5763 10	Gold brass plate - 2 module	3306	1/5/30
5763 30	Gold brass plate -3 module	3554	1/20
5763 50	Gold brass plate - 4 module	3772	1/20
5763 80	Gold brass plate - 6 module	6864	1/5
5764 00	Gold brass plate - 8 module	7548	1/5
5757 06	Stainless steel plate - 1 module	3088	1/5/30
5757 16	Stainless steel plate - 2 module	3306	1/5/30
5757 26	Stainless steel plate - 3 module	3554	1/20
5757 36	Stainless steel plate - 4 module	3772	1/20
5757 46	Stainless steel plate - 6 module	6864	1/5
5757 66	Stainless steel plate - 2x4 module	9544	1/10
5757 56	Stainless steel plate - 8 module	7548	1/5
5757 76	Stainless steel plate - 2x6 module	11760	1/8



5758 63



5758 64



5762 90



5763 30



5757 16



5758 81



5758 82



5758 72



5758 73

## Arteor™ square - white mechanisms

Cat.Nos	Description	MRP* ₹ / Unit	Pack
---------	-------------	------------------	------

### Wood cover plates with Overmoulded frame

5758 80	Grey Oak plate - 1 module	1810	1/5/30
5758 81	Grey Oak plate - 2 module	1918	1/5/30
5758 82	Grey Oak plate - 3 module	2370	1/20
5758 83	Grey Oak plate - 4 module	2624	1/20
5758 84	Grey Oak plate - 6 module	3904	1/5
5758 85	Grey Oak plate - 8 module	4692	1/5
5758 86	Grey Oak plate - 2x4 module	5570	1/10
5758 87	Grey Oak plate - 2x6 module	7464	1/8

### Signature cover plates with Overmoulded frame

5758 71	Cube plate - 1 module	5920	1/5/30
5758 72	Cube plate - 2 module	6028	1/5/30
5758 73	Cube plate - 3 module	6892	1/20
5758 74	Cube plate - 4 module	7122	1/20
5758 75	Cube plate - 6 module	9274	1/5
5758 76	Cube plate - 8 module	9736	1/5
5758 77	Cube plate - 2x4 module	14548	1/10
5758 78	Cube plate - 2x6 module	16116	1/8

### Cover plates without frame Plate without frame#

575710PL#	Plate 2m sq white #Suitable only for wireless switch	154	5/50
575711PL#	Plate 2m sq pearl aluminium #Suitable only for wireless switch	308	5/50
575712PL#	Plate 2m sq graphite #Suitable only for wireless switch	246	5/50
575812PL#	Plate 2m sq magnesium #Suitable only for wireless switch	308	5/50
575823PL#	Plate 2m sq champagne #Suitable only for wireless switch	308	5/50
575834PL#	Plate 2m sq dark bronze #Suitable only for wireless switch	308	5/50

### Accessory

0648 71	Pack of 3 x 4 extra removable stickers for fixing a wireless control	570	1/25
---------	--	-----	------

\* MRP - Maximum Retail Price Inclusive of all taxes including GST.  
# To be Introduced Shortly, (1) Supplied with white plate  
#Suitable only for wireless switch, ■ Price available on request

Bold Cat.Nos are products normally available with Legrand (India) Stockists. Cat.Nos that are not bold - delivery within 4 - 8 weeks from the date of order. Bold packing quantity is our mandatory packing. Orders to be placed by Legrand (India) Stockist in multiples of the same.



# MYRIUS<sup>®</sup>

## NEXTGEN

### INSPIRED BY YOUR LOVE FOR AESTHETICS AND CONVENIENCE

Who said beauty has to be compromised at the hands of technology! The Myrius NextGen range seamlessly combines the aesthetic beauty of designer finishes with hues and patterns, achieved through cutting-edge IMD technology, with the intelligence of IoT functions. This means customized, smart functions for you to enjoy the convenience of living and a stunning designer look that will turn heads, every time guests come over.



Scan to know more about  
the product.





Luminar

Trinity

Interlude

Stellar

Sonic Silver

Pearl Champagne

Dark Fade

Ice White

Ice Black

Classic White

### Switches - Classic white

Cat.Nos	Description	MRP ₹ / Unit	Pack
---------	-------------	--------------------	------

#### Mechanisms White Switches 6A 230VAC

6792 00	6A Switch 1 way 1M White	144	20/200
6792 01	6A Switch 2 way 1M White	236	20/200
6792 02	6A Switch 1 way 1M with Indicator White	218	20/200
6792 03	6A Switch 1 way 1M light marking White	188	20/200
6792 04	6A Switch 1 way 1M with fan marking White	188	20/200

#### Switches 10A 230VAC

6792 05	10A Switch 1 way 2M White	276	10/100
6792 06	10A Switch 2 way 2M White	326	10/100
6792 07	10A intermediate Switch 2M White	1778	10/100
6792 08	10A Switch 1 way 2M with Indicator White	340	10/100

#### Switches 16A 230VAC

6792 09	16A Switch 1 way 1M White	310	20/200
6792 10	16A Switch 2 way 1M White	356	20/200
6792 11	16A Switch 1 way 1M with Indicator White	378	20/200

#### Switches 20A 230VAC

6792 12	20A Switch 1 way 1M White	414	20/200
6792 13	20A DP Switch 1 way 2M White	630	10/100
6792 14	20A DP Switch 1 way 2M with Indicator White	670	10/100
6792 15	20A Switch 2 way 2M White	694	10/100

#### Sockets, Regulators, Hospitality Function Switches 25A 230VAC

6792 16	25A SP 1 way with Indicator 1M White	462	20/200
---------	--------------------------------------	-----	--------

#### Switches 32A 230VAC

6792 17	32A DP Switch 2M with Indicator White	1030	10/100
---------	---------------------------------------	------	--------

\* MRP - Maximum Retail Price Inclusive of all taxes including GST.  
■ Price available on request

### Sockets, Regulators, Hospitality Function

Cat.Nos	Description	MRP ₹ / Unit	Pack
---------	-------------	--------------------	------

#### Push button 6A 230VAC

6792 18	6A push button SP 1M White	262	20/200
6792 19	6A push button SP 1 way 1M with Indicator White	340	20/200
6792 20	6A bell push 1 way 1M White	260	20/200
6792 21	6A bell push 1 way 1M with Indicator White	340	20/200
6792 22	6A bell push 1 way 2M White	392	10/100
6792 23	6A bell push 1 way 2M with Indicator White	462	10/100

#### Accessories for switches

6792 24	Lamp for Switches 230V AC	60	5/50
---------	---------------------------	----	------

### Sockets, Regulators, Hospitality Function

#### Sockets 240VAC

6792 25	6/16A 2 Pin Euro US Socket 1M White	358	20/200
6792 26	16A 3 Pin Switched Socket 3M White	1176	5/50
6792 27	Multistandard Socket 2M White 6/10/13A 2/3 Pin for 250V AC 15A for 127V Type 2 Pin	392	10/100
6792 28	6A 5 Pin Universal Socket White	338	20/200
6792 29	6/16A Socket 3M White	546	5/50
6792 30	6/16A Socket 2M White	458	10/100
6792 32	25A Socket 2M White	578	10/100
<b>6792 35</b>	6A 3-Pin ISI socket 2 module	240	1/20/200

#### Dimmers And Fan regulators

6792 36	Rotary Dimmer 400W 1M White	1138	5/50
6792 37	Rotary Light Dimmer 500W 2M White	1716	10/100
6792 39	Fan Regulator 100W 1M White	884	5/50
6792 40	Fan Regulator 100W 360 Degree 2M White	1012	10/100
6792 41	Fan Regulator 120W 360 Degree 2M White	1094	10/100
6792 42	Fan Regulator 70W 2M White	1060	1/10/100
<b>6792 31</b>	Fan regulator 8 step 100w 2 Module	926	1/10/100

#### Emergency Light

6792 43	Removable LED lamp 2M White	2844	1/10/100
---------	-----------------------------	------	----------

#### Skirting Light

6792 48	Skirting light with warm White LED 3M White	860	5/25
---------	---	-----	------

Bold Cat.Nos are products normally available with Legrand (India) Stockists. Cat.Nos that are not bold - delivery within 4 - 8 weeks from the date of order. Bold packing quantity is our mandatory packing. Orders to be placed by Legrand (India) Stockist in multiples of the same.

### Hospitality Functions, Sockets, Electronic Function

Cat.Nos	Description	MRP ₹ / Unit	Pack
---------	-------------	--------------------	------

#### Indicator

6792 87	Indicator Unit 1M W/ transparent LED W/ colored labels White	660	1/10/100
---------	--	-----	----------

#### Bell call indicator

6792 49	Bell call Indicator 1M White	1132	20/200
---------	------------------------------	------	--------

#### Buzzer

6792 50	Buzzer 230V 1M White	1224	20/200
---------	----------------------	------	--------

#### Infrared Sensors

6792 51	Infrared Sensor Switch 400W 2M White	2002	1/50
---------	---	------	------

#### Remote Unit

6792 52	Remote control unit for Light and Fan 4M White	6828	1/5/20
6793 03	Remote control hand unit	604	1/5/30

#### Hospitality Function

##### Hotel Keycard Switch

6792 53	16A Hotel key FOB Switch 2M White	4098	1/10
6792 55	Credit card size Key FOB	180	10/100

### Hospitality Functions, Sockets, Electronic Function

#### Hotel "DND And MMR" functions

6792 56	DND & CMR Indicator 1M + 1M Bell Push White	1748	10/100
6792 57	DND & CMR (inside) White	1168	10/100

#### Shaver socket

6792 58	Shaver Socket 110/230V AC Monoblock width / plate 2M White	3050	1/16
6792 59	Shaver Socket 110/230V AC Monoblock W/ plate White 4M	4978	1/5/20

#### SocketsAnd connectors

##### TV sockets

6792 60	TV co-axial Socket White	230	20/200
---------	--------------------------	-----	--------

#### Data & Voice

6792 62	RJ11 Telephone White	228	20/200
6792 63	Double RJ11 Telephone White	352	20/200
6792 64	RJ 45 UTP cat 5 tooless with shutter 1M White	550	20/200
6792 65	RJ 45 UTP cat 6 tooless with shutter 1M White	818	20/200
6792 66	RJ 45 UTP cat 6 tooless with shutter 2M White	832	10/100

#### Audio Video Connectors

6792 67	Preterminated AV connector 1M White	1786	1/10
6792 68	Preterminated projector connector 1M White	2188	1/10

### Electronic Function, Switches - Charcoal Grey

Cat.Nos	Description	MRP ₹ / Unit	Pack
---------	-------------	--------------------	------

#### Audio Video Connectors

6792 69	Preterminated HDMI Socket 1M White	2188	1/10
---------	---------------------------------------	------	------

#### Sound (Volume controller)

6792 70	Volume controller 2M	1338	1/10/100
---------	----------------------	------	----------

#### Protectors and Accessories

##### Motor Starter

6792 71	16A Motor starter 2M White	730	1/10/100
6792 72	25A Motor starter 2M White	744	1/10/100

#### Electronic Function

##### USB chargers (IS13252 (Part 1) / IEC 60950-1)

6792 88	USB charger 1500 mA 1M type A White	1592	1/5/50
6792 89	USB charger 3000 mA 2M type A & C White	2462	1/10/100
6792 90	USB charger 1500 mA 1M type C White	1750	1/5/50

#### Combi (Socket+USB)

6792 92	Combi twin USB 3100 mA multistandard Socket type A White	3278	1/5/50
6792 93	Combi twin USB 3100 mA multistandard Socket type A & type C White	3612	1/5/50
6792 94	Combi twin USB 3100 mA multistandard Socket type C White	3612	1/5/50
<b>6792 33</b>	Combi twin USB 3.1A Euro Socket type A - 2 module	2052	1/10/100
<b>6792 34</b>	Combi twin USB 3.1A Euro Socket type A & type C - 2 module	2462	1/10/100

#### Wireless Charger

6792 95	Induction charger 1A wire- less 2.4A USB + Dock 2M sup width/ mech White <small>**Charging only with wireless compatible phone having induction receiver technology</small>	7176	1/4
---------	--	------	-----

#### Loud Speakers

6792 98	Ceiling Loudspeaker 8 Ohms 100mm White	2798	1/6
---------	---	------	-----

#### Sound Diffusion

6792 99	Bluetooth Sound Diffusion 2M White	5730	1/10/100
---------	---------------------------------------	------	----------

#### Rotary Dimmer Universal

6793 04	Rotary LED light dimmer 1M - 50W White	2354	1/10/120
---------	---	------	----------

#### Touch Switches

6793 08	Touch Switch 2M 1 way-2 Switch 1000W	3502	1/50
6793 09	Touch Switch 2M 1 way 1440W	3502	1/50
6793 10	Touch Switch 2M 2 way 1000W	4044	1/50

\* MRP - Maximum Retail Price Inclusive of all taxes including GST.

■ To be Introduced Shortly

(1) Supplied with white plate

■ Price available on request

Bold Cat.Nos are products normally available with Legrand (India) Stockists. Cat.Nos that are not bold - delivery within 4 - 8 weeks from the date of order. Bold packing quantity is our mandatory packing. Orders to be placed by Legrand (India) Stockist in multiples of the same.



### Switches - Charcoal Grey

Cat.Nos	Description	MRP ₹ / Unit	Pack
---------	-------------	--------------------	------

#### Touch Switches

6793 13	Touch Switch 2M 1 way 3000W	4044	1/50
6793 06	Touch Switch Bell Push 2M 1440W	3502	1/50

#### Touch Regulator, Curtain & Dimmer

6793 07	Touch Switch - curtain controller 2M	4044	1/50
6793 05	Touch Fan regulator 2M 100W	4044	1/50
6793 15	300W Universal LED Touch scroll dimmer 2M	4004	1/50

#### Reading Light

6793 16	Reading Light LED 2M White	2254	1/10
---------	----------------------------	------	------

#### Accessories

6792 75	Cable outlet 8mm 1M White	258	20/200
6792 76	Blanking plate 1M White	46	40/400
6792 77	Blanking plate 2M White	54	10/100

#### Mechanisms Grey Switches 6A 230V AC

6794 00	6A Switch 1 way 1M Charcoal Grey	176	20/200
6794 01	6A Switch 2 way 1M Charcoal Grey	262	20/200
6794 02	6A Switch 1 way 1M with Indicator Charcoal Grey	288	20/200
6794 03	6A Switch 1 way 1M with light marking Charcoal Grey	222	20/200
6794 04	6A Switch 1 way 1M with Fan marking Charcoal Grey	222	20/200

#### Switches 10A 230V AC

6794 05	10A Switch 1 way 2M Charcoal Grey	330	10/100
6794 06	10A Switch 2 way 2M Charcoal Grey	356	10/100
6794 07	10A Intermediate Switch 2M Charcoal Grey	2048	10/100
6794 08	10A Switch 1 way 2M with Indicator Charcoal Grey	380	10/100

#### Switches 16A 230V AC

6794 09	16A Switch 1 way 1M Charcoal Grey	348	20/200
6794 10	16A Switch 2 way 1M Charcoal Grey	418	20/200
6794 11	16A Switch 1 way 1M with Indicator Charcoal Grey	434	20/200

#### Switches 20A 230V AC

6794 12	20A Switch 1 way 1M Charcoal Grey	466	20/200
6794 13	20A DP Switch 1 way 2M Charcoal Grey	728	10/100

### Sockets, Regulators, Hospitality Function

Cat.Nos	Description	MRP ₹ / Unit	Pack
---------	-------------	--------------------	------

#### Switches 20A 230V AC

6794 14	20A DP Switch 1 way 2M with Indicator Charcoal Grey	772	10/100
6794 15	20A Switch 2 way 2M Charcoal Grey	796	10/100

#### Switches 25A 230V AC

6794 16	25A SP 1 way with Indicator Charcoal Grey 1M	534	20/200
---------	--	-----	--------

#### Switches 32A 230V AC

6794 17	32A DP Switch 2M with Indicator Charcoal Grey	1188	10/100
---------	---	------	--------

#### Push button 6A 230V AC

6794 18	6A Push Button SP 1 way 1M Charcoal Grey	306	20/200
6794 19	6A Push Button 1way 1M with Indicator Charcoal Grey	384	20/200
6794 20	6A Bell Push 1 way 1M Charcoal Grey	288	20/200
6794 21	6A Bell Push 1 way 1M with Indicator Charcoal Grey	384	20/200
6794 22	6A Bell Push 1 way 2M Charcoal Grey	448	10/100
6794 23	6A Bell Push 1 way 2M with Indicator Charcoal Grey	534	10/100

#### Sockets 240V AC

6794 24	6/16A 2 Pin Euro US Socket 1M Charcoal Grey	416	20/200
6794 26	16A 3 Pin Switched Socket 3M Charcoal Grey	1342	5/50
6794 25	Multistandard Socket 2M Charcoal Grey 6/10/13A 2/3 Pin for 250V AC 15A for 127V Type 2 Pin	458	10/100
6794 28	6A 5 Pin Universal Socket Charcoal Grey	372	20/200
6794 29	6/16A Socket 3M Charcoal Grey	632	5/50
6794 30	6/16A Socket 2M Charcoal Grey	536	10/100
6794 32	25A Socket 2M Charcoal Grey	656	10/100
6794 35	6A 3-Pin ISI Socket 2 module	270	1/20/200

#### Dimmers and Fan Regulators

6794 36	Rotary Dimmer 400W 1M Charcoal Grey	1300	5/50
6794 37	Rotary Light Dimmer 500W 2M Charcoal Grey	1974	10/100
6794 39	Fan Regulator 100W 1M Charcoal Grey	1014	5/50
6794 40	Fan Regulator 100W 360 Degree 2M Charcoal Grey	1152	10/100
6794 41	Fan Regulator 120W 360 Degree 2M Charcoal Grey	1266	10/100
6794 42	Fan Regulator 70W 2M Charcoal Grey	1224	1/10/100
6794 31	Fan regulator 8 step 100w 2 module	1054	1/10/100

\* MRP - Maximum Retail Price Inclusive of all taxes including GST.  
■ Price available on request

Bold Cat.Nos are products normally available with Legrand (India) Stockists. Cat.Nos that are not bold - delivery within 4 - 8 weeks from the date of order. Bold packing quantity is our mandatory packing. Orders to be placed by Legrand (India) Stockist in multiples of the same.

### Hospitality Functions, Sockets, Electronic Function

Cat.Nos	Description	MRP ₹ / Unit	Pack
---------	-------------	-----------------	------

#### Skirting Light

6794 48	Skirting Light with Warm White LED 3M Charcoal Grey	986	5/25
---------	---	-----	------

#### Bell call indicator

6794 49	Bell Call Indicator 1M Charcoal Grey	1320	20/200
---------	--------------------------------------	------	--------

#### Buzzer

6794 50	Buzzer 230V 1M Charcoal Grey	1406	20/200
---------	------------------------------	------	--------

#### Remote Unit

6794 52	Remote control unit for light and fan 4M Charcoal Grey	7850	1/5/20
6793 03	Remote control hand unit	604	1/5/30

#### Hospitality Function Hotel Keycard Switch

6794 53	16A Hotel key FOB Switch Charcoal Grey	4712	1/10
6792 55	Credit card size Key FOB	180	10/100

#### Hotel "DND and MMR" Functions

6794 54	DND & CMR Indicator 1M + 1M Bell Push Charcoal Grey	2004	10/100
6794 55	DND & CMR (inside) Charcoal Grey	1324	10/100

#### Shaver socket

6794 58	Shaver Socket 120/240V AC Monoblock with plate 2M Charcoal Grey	3474	1/16
6794 59	Shaver socket 120/230V AC monoblock with plate 4M Charcoal Grey	5506	1/5/20

#### Sockets and Connectors

##### TV Sockets

6794 60	T.V co-axial Socket Charcoal Grey	278	20/200
---------	-----------------------------------	-----	--------

##### Data & Voice

6794 62	RJ11 Telephone Charcoal Grey	266	20/200
6794 63	Double RJ11 Telephone Charcoal Grey	406	20/200
6794 64	RJ 45 UTP cat 5 tooless with shutter 1M Charcoal Grey	636	20/200
6794 65	RJ 45 UTP cat 6 tooless with shutter 1M Charcoal Grey	938	20/200
6794 66	RJ 45 UTP cat 6 tooless with shutter 2M Charcoal Grey	960	10/200

##### Audio-Video Sockets

6794 67	Preterminated AV connector 1M Charcoal Grey	2050	1/10
---------	---	------	------

### Electronic Function, Plate with Frame

Cat.Nos	Description	MRP ₹ / Unit	Pack
---------	-------------	-----------------	------

#### Audio-Video Sockets

6794 68	Preterminated HDMI socket 1M Charcoal Grey	2514	1/10
6794 69	Preterminated projector connector 1M Charcoal Grey	2514	1/10

#### Sound (Volume Controller)

6794 70	Volume Controller 2M Charcoal Grey	1552	1/10/100
---------	------------------------------------	------	----------

#### Protectors and Accessories Motor Starter

6794 71	16A Motor Starter 2M Charcoal Grey	838	1/10/100
6794 72	25A Motor Starter 2M Charcoal Grey	860	1/10/100

#### Electronic Function

##### USB chargers (IS13252 (Part 1) / IEC 60950-1)

6794 88	USB charger 1500 mA 1M type A Charcoal Grey	1828	1/5/100
6794 89	USB charger 3000 mA 2M type A & C Charcoal Grey	2832	1/10/100
6794 90	USB charger 1500 mA 1M type C Charcoal Grey	2012	1/5/100

##### Combi (Socket + USB)

6794 92	Combi twin USB 3100 mA Multistandard Socket type A Charcoal Grey	3770	1/5/50
6794 93	Combi twin USB 3100 mA Multistandard Socket type A & type C Charcoal Grey	4150	1/5/50
6794 94	Combi twin USB 3100 mA Multistandard socket type C Charcoal Grey	4150	1/5/50
<b>6794 33</b>	Combi twin USB 3.1A Euro Socket type A - 2 module	2358	1/10/100
<b>6794 34</b>	Combi twin USB 3.1A Euro Socket type A & type C - 2 module	2830	1/10/100

#### Sound Receiver

6794 97	Bluetooth sound diffusion 2M Charcoal Grey	6592	1/10/100
---------	--	------	----------

#### Rotary Dimmer Universal

6794 98	Rotary LED Light Dimmer 1M-50W Charcoal Grey	2680	1/10/120
---------	--	------	----------

#### Accessories

6794 75	Cable outlet 8mm 1M Charcoal Grey	302	20/200
6794 76	Blanking Plate 1M Charcoal Grey	52	40/400

#### Plate Frame Plate Frame White

6795 01	Plate+frame 1M White	184	20/200
---------	----------------------	-----	--------



6794 49



6794 52

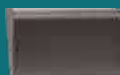

6794 53



6794 55



6794 60



6794 62



6794 64



6794 67



6794 70



6794 71



6794 89



6794 92

NEW!

NEW!



6794 97



6794 98



6794 75

\* MRP - Maximum Retail Price Inclusive of all taxes including GST.

■ To be Introduced Shortly

(1) Supplied with white plate

■ Price available on request

Bold Cat.Nos are products normally available with Legrand (India) Stockists. Cat.Nos that are not bold - delivery within 4 - 8 weeks from the date of order. Bold packing quantity is our mandatory packing. Orders to be placed by Legrand (India) Stockist in multiples of the same.



### Plates with frame

Cat.Nos	Description	MRP ₹ / Unit	Pack
---------	-------------	-----------------	------

#### Plate Frame White

6795 02	Plate+frame 2M White	192	20/200
6795 03	Plate+frame 3M White	206	10/100
6795 04	Plate+frame 4M White	226	10/100
6795 06	Plate+frame 6M White	392	5/50
6795 08	Plate+frame 8M White	432	5/50
6795 09	Plate+frame 2x4M White	548	5/25
6795 10	Plate+frame 9M White	576	5/50
6795 12	Plate+frame 12M White	652	10
6795 16	Plate+frame 16M White	762	10
6795 18	Plate+frame 18M White	874	10

#### Plate Frame Ice White

6795 21	Plate+frame 1M Ice White	244	1/5/30
6795 22	Plate+frame 2M Ice White	260	1/5/30
6795 23	Plate+frame 3M Ice White	276	1/20
6795 24	Plate+frame 4M Ice White	296	1/20
6795 26	Plate+frame 6M Ice White	534	1/10
6795 28	Plate+frame 8M Ice White	582	1/10
6795 29	Plate+frame 2x4M Ice White	728	1/5
6795 32	Plate+frame 12M Ice White	882	1/5
6795 36	Plate+frame 16M Ice White	1028	1/5
6795 38	Plate+frame 18M Ice White	1180	1/5

#### Plate Frame Ice Black

6795 41	Plate+frame 1M Ice Black	244	1/5/30
6795 42	Plate+frame 2M Ice Black	260	1/5/30
6795 43	Plate+frame 3M Ice Black	276	1/20
6795 44	Plate+frame 4M Ice Black	296	1/20
6795 46	Plate+frame 6M Ice Black	534	1/10
6795 48	Plate+frame 8M Ice Black	582	1/10
6795 49	Plate+frame 2x4M Ice Black	728	1/5
6795 52	Plate+frame 12M Ice Black	882	1/5
6795 56	Plate+frame 16M Ice Black	1028	1/5
6795 58	Plate+frame 18M Ice Black	1180	1/5

#### Plate Frame Pearl Champagne

6795 61	Plate+frame 1M Pearl Champagne	336	1/5/30
6795 62	Plate+frame 2M Pearl Champagne	354	1/5/30
6795 63	Plate+frame 3M Pearl Champagne	374	1/20

### Plates with frame

Cat.Nos	Description	MRP ₹ / Unit	Pack
---------	-------------	-----------------	------

#### Plate Frame Pearl Champagne

6795 64	Plate+frame 4M Pearl Champagne	408	1/20
6795 66	Plate+frame 6M Pearl Champagne	728	1/10
6795 68	Plate+frame 8M Pearl Champagne	796	1/10
6795 69	Plate+frame 2x4M Pearl Champagne	996	1/5
6795 72	Plate+frame 12M Pearl Champagne	1204	1/5
6795 76	Plate+frame 16M Pearl Champagne	1402	1/5
6795 78	Plate+frame 18M Pearl Champagne	1612	1/5

#### Plate Frame Sonic Silver

6795 81	Plate+frame 1M Sonic Silver	336	1/5/30
6795 82	Plate+frame 2M Sonic Silver	354	1/5/30
6795 83	Plate+frame 3M Sonic Silver	374	1/20
6795 84	Plate+frame 4M Sonic Silver	408	1/20
6795 86	Plate+frame 6M Sonic Silver	728	1/10
6795 88	Plate+frame 8M Sonic Silver	796	1/10
6795 89	Plate+frame 2x4M Sonic Silver	996	1/5
6795 92	Plate+frame 12M Sonic Silver	1204	1/5
6795 96	Plate+frame 16M Sonic Silver	1402	1/5
6795 98	Plate+frame 18M Sonic Silver	1612	1/5

#### Plate Frame Dark Fade

6796 01	Plate+frame 1M Dark Fade	336	1/5/30
6796 02	Plate+frame 2M Dark Fade	354	1/5/30
6796 03	Plate+frame 3M Dark Fade	374	1/20
6796 04	Plate+frame 4M Dark Fade	408	1/20
6796 06	Plate+frame 6M Dark Fade	728	1/10

\* MRP - Maximum Retail Price Inclusive of all taxes including GST.  
 Red Cat.Nos - new products  
 ■ Price available on request.

Bold Cat.Nos are products normally available with Legrand (India) Stockists.  
 Cat.Nos that are not bold - delivery within 4 - 8 weeks from the date of order.  
 Bold packing quantity is our mandatory packing. Orders to be placed by Legrand (India) Stockist in multiples of the same.

### Plates with frame

Cat.Nos	Description	MRP ₹ / Unit	Pack
---------	-------------	--------------------	------

#### Plate Frame Dark Fade

6796 08	Plate+frame 8M Dark Fade	796	1/10
6796 09	Plate+frame 2x4M Dark Fade	996	1/5
6796 12	Plate+frame 12M Dark Fade	1204	1/5
6796 16	Plate+frame 16M Dark Fade	1402	1/5
6796 18	Plate+frame 18M Dark Fade	1612	1/5

#### Plate Frame Interlude

6796 21	Plate+frame 1M Interlude	426	1/5/30
6796 22	Plate+frame 2M Interlude	448	1/5/30
6796 23	Plate+frame 3M Interlude	478	1/20
6796 24	Plate+frame 4M Interlude	518	1/20
6796 26	Plate+frame 6M Interlude	926	1/10
6796 28	Plate+frame 8M Interlude	1008	1/10
6796 29	Plate+frame 2x4M Interlude	1264	1/5
6796 32	Plate+frame 12M Interlude	1526	1/5
6796 36	Plate+frame 16M Interlude	1784	1/5
6796 38	Plate+frame 18M Interlude	2044	1/5

#### Plate Frame Trinity

6796 41	Plate+frame 1M Trinity	426	1/5/30
6796 42	Plate+frame 2M Trinity	448	1/5/30
6796 43	Plate+frame 3M Trinity	478	1/20
6796 44	Plate+frame 4M Trinity	518	1/20
6796 46	Plate+frame 6M Trinity	926	1/10
6796 48	Plate+frame 8M Trinity	1008	1/10
6796 49	Plate+frame 2x4M Trinity	1264	1/5

### Mounting boxes

Cat.Nos	Description	MRP ₹ / Unit	Pack
---------	-------------	--------------------	------

6796 52	Plate+frame 12M Trinity	1526	1/5
6796 56	Plate+frame 16M Trinity	1784	1/5
6796 58	Plate+frame 18M Trinity	2044	1/5

#### Plate Frame Luminar

6796 61	Plate+frame 1M Luminar	426	1/5/30
6796 62	Plate+frame 2M Luminar	448	1/5/30
6796 63	Plate+frame 3M Luminar	478	1/20
6796 64	Plate+frame 4M Luminar	518	1/20
6796 66	Plate+frame 6M Luminar	926	1/10
6796 68	Plate+frame 8M Luminar	1008	1/10
6796 69	Plate+frame 2x4M Luminar	1264	1/5
6796 72	Plate+frame 12M Luminar	1526	1/5
6796 76	Plate+frame 16M Luminar	1784	1/5
6796 78	Plate+frame 18M Luminar	2044	1/5

#### Plate Frame Stellar

6796 81	Plate+frame 1M Stellar	426	1/5/30
6796 82	Plate+frame 2M Stellar	448	1/5/30
6796 83	Plate+frame 3M Stellar	478	1/20
6796 84	Plate+frame 4M Stellar	518	1/20
6796 86	Plate+frame 6M Stellar	926	1/10
6796 88	Plate+frame 8M Stellar	1008	1/10
6796 89	Plate+frame 2x4M Stellar	1264	1/5
6796 92	Plate+frame 12M Stellar	1526	1/5
6796 96	Plate+frame 16M Stellar	1784	1/5
6796 98	Plate+frame 18M Stellar	2044	1/5

#### Metal flush boxes

6890 07	Flush box - 1/2M	138	40
6890 08	Flush box - 3M	138	40
6890 09	Flush box - 4M	184	40
6890 10	Flush box - 6M	288	40

\* MRP - Maximum Retail Price Inclusive of all taxes including GST.

\* To be Introduced Shortly

Red Cat.Nos - new products

(1) Supplied with white plate

■ Price available on request

Note: For MRP of mounting boxes please refer main pricelist.

### Metal flush boxes

Cat.Nos	Description	MRP ₹ / Unit	Pack
6890 42	Flush box - 8M	338	40
6890 31	Flush box - 8M (2 row x 4)	336	20
6890 29	Flush box - 9 module	398	20
6890 11	Flush box - 12/16 (2 row x 6)M	508	10
6890 12	Flush box - 18M	640	10



6733 03

### Plastic surface boxes

6733 02	Surface box - 1/2M	88	10/50
6733 03	Surface box - 3M	102	5/35
6733 04	Surface box - 4M	118	5/25
6733 06	Surface box - 6M	154	1/10
6733 08	Surface box - 8M	230	1/5
6733 05	Surface box - 8 (2 row x 4)M	218	1/5

### Metal surface boxes

6890 21	Surface Box - 12/16 (2x 6)M	542	1/6
6890 22	Surface Box - 18M	568	1/4

### Mechanism AntiBacterial Switches 6A 230V AC

6793 20	6A switches 1 way 1M White Anti-Bacterial	202	20/200
6793 21	6A switches 2 way 1M White Anti-Bacterial	280	20/200
6793 24	6A Bell push 1M White Anti-Bacterial	318	20/200

6793 20

### Switches 16A 230V AC

6793 22	16A switches 1 way 1M White Anti-Bacterial	378	20/200
6793 23	16A switches 2 way 1M White Anti-Bacterial	434	20/200

6793 22

### Sockets 240V AC

6793 26	Multistandard Socket 6/10/13A 2/3 Pin for 250V AC 15 A for 127V type 2 Pin 2M White Anti-Bacterial	470	10/100
6793 27	6A 2/3 Pin Universal Socket 2M White Anti- Bacterial	410	20/200
6793 28	6/16A Socket 2M White Anti-Bacterial	626	10/100

6793 26



6793 29

**NEW!**



6793 25



6793 32



6793 42



6793 44



6793 48



6793 52



6793 58

### Mechanism AntiBacterial

Cat.Nos	Description	MRP ₹ / Unit	Pack
6793 29	6/16A Socket 3M White Anti-Bacterial	670	5/50
<b>6792 38</b>	6A 3-Pin ISI Socket 2 module	300	1/20/200

### Fan Regulators

6793 25	Fan Regulator 120W 360 degree 2M White Anti- Bacterial	1344	10/100
---------	--	------	--------

### TV Sockets

6793 30	T.V. Socket 1M White Anti-Bacterial	278	20/200
---------	--	-----	--------

### Data & Voice

6793 31	RJ11 Telephone Socket 1M White Anti-Bacterial	278	20/200
6793 32	RJ45 cat 6 UTP 1M White Anti-Bacterial	994	20/200

### Accessories

6793 33	Blanking plate 1M White Anti-Bacterial	46	40/400
---------	---	----	--------

### Plate Frame Antibacterial

6793 41	Plate+frame 1M White Anti-Bacterial	200	20/200
6793 42	Plate+frame 2M White Anti-Bacterial	224	20/200
6793 43	Plate+frame 3M White Anti-Bacterial	250	10/100
6793 44	Plate+frame 4M White Anti-Bacterial	268	10/100
6793 46	Plate+frame 6M Anti- Bacterial	436	5/50
6793 48	Plate+frame 8M White Anti- Bacterial	514	5/50
6793 49	Plate+frame 2x4M White Anti-Bacterial	642	5/25
6793 50	Plate+frame 9M White Anti-Bacterial	668	5/50
6793 52	Plate+frame 12M White Anti-Bacterial	734	10
6793 56	Plate+frame 16M White Anti-Bacterial	872	10
6793 58	Plate+frame 18M Anti- Bacterial	970	10

\* MRP - Maximum Retail Price Inclusive of all taxes including GST.

■ To be Introduced Shortly

■ Red Cat.Nos - new products

(1) Supplied with white plate

■ Price available on request

Bold Cat.Nos are products normally available with Legrand (India) Stockists. Cat.Nos that are not bold - delivery within 4 - 8 weeks from the date of order. Bold packing quantity is our mandatory packing. Orders to be placed by Legrand (India) Stockist in multiples of the same.

# MYRIUS<sup>®</sup>

## NEXTGEN

### INSPIRED BY YOUR HEALTH-FIRST MANTRA

You prioritize your family's health, hygiene and wellness more than anything else. Inspired, we've created anti-bacterial plates infused with silver ions, which do not let bacteria grow on the surface of Switches and Plates and Accessories throughout its lifespan. One less reason to worry about germs being passed on at home. Live the advantage of a healthy home



ANTI-BACTERIAL RANGE





# MYRIUS<sup>®</sup>

NEXTGEN

INSPIRED BY TOUCH,  
SWIPE AND YOUR  
VOICE.

Be it controlling operations of lights or curtains remotely or controlling power outlets or viewing energy consumption details – we've got your back in multiple ways that you love. Control functions via voice commands used in combination with multiple ways. You can still use it in the traditional way via switches on wall. Also even by simply swiping on the Home+Control Smartphone app by Legrand.



Scan to know more about  
the product.



works with the  
Google Assistant



WORKS WITH  
alexa



Works with  
Apple HomeKit

Works with  
**IFTTT**

Control with:

**TOUCH | SWIPE | TALK**

# MYRIUS<sup>®</sup>

NEXTGEN

## SMART SOLUTIONS FOR YOUR SMART NEED.

The Myrius NextGen IoT range has been meticulously crafted by us for you and your family's connected, real-time, smart living. Each product combines Legrand's design calibre and the intelligence of the Internet of Things, which brings convenience of different levels to you. Solutions and devices with the power to communicate with each other and complete tasks, supervise scenarios or monitor and give you crucial updates.



**WIRELESS 4  
SCENARIO  
CONTROL - 2M**



**SWITCH DIMMER  
WITH  
NEUTRAL - 1M**



**WIRELESS SWITCH  
2G - 2M**



**IN WALL WIRELESS  
SWITCH - 1M**



Scan to know more about  
the product.

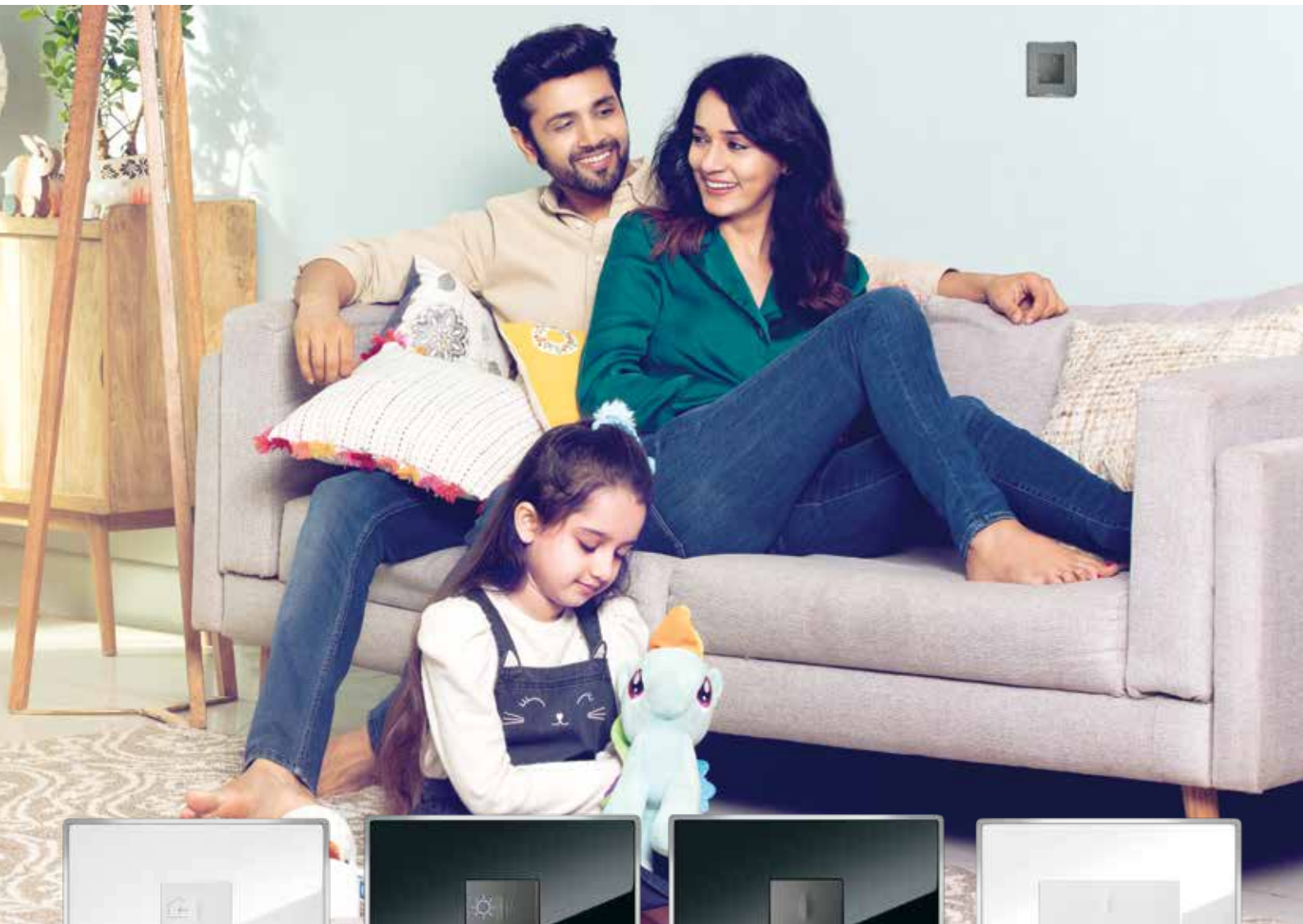

**IN WALL MASTER  
HOME  
IN/AWAY - 1M**



**IN WALL MASTER  
WAKE UP/SLEEP -  
1M**



**IN WALL WIRELESS  
SHUTTER SWITCH  
- 1M**



**SWITCH WITH NEUTRAL  
WITH DIMMER  
OPTION - 2M**



### White Mechanism Sockets, Regulators, Hospitality Function

Cat.Nos	Description	MRP* ₹ / Unit	Pack
---------	-------------	------------------	------

#### Connected light Switches

6793 59	Switch with neutral, wired, 1 module	8530	1/5/50
6793 60	Switch without neutral, with dimmer option, wired, 2 modules	11226	1/5/50
<b>6793 70</b>	Switch dimmer with neutral 150W, 1 module	6656	1/5/30
<b>6793 71</b>	Switch dimmer with neutral, wired, 2 modules	11360	1/5/30

#### Connected Outlets

6793 67	Connected socket outlet module - 16A - 240VA - 3680 W, 1 module	8934	1/5/50
---------	---	------	--------

#### Connected Curtain/Roller Blind Switches

6793 61	Connected curtain/roller blind switch wired, 1 module	9188	1/5/50
---------	---	------	--------

#### Connected Gateway Pack

6793 66	Connected gateway + Master home away wireless switch wired, 2 module	18762	1/5/20
---------	--	-------	--------

#### Connected Wireless Controls

6793 62	Wireless light switch	4130	1/5/30
6793 64	Curtain/roller blind wireless switch	4658	1/5/30
<b>6793 73</b>	2G Wireless switch, 2 module	4160	1/5/30

#### Connected Wireless Scene Switches

6793 63	Home/Away wireless master switch	4374	1/5/30
6793 65	Wake up/Sleep wireless switch	4768	1/5/30
<b>6793 69</b>	Wireless 4 scenario control switch, 2 module	5200	1/5/30

#### IN Wall Wireless Switch

<b>6793 72</b>	IN wall wireless light switch - 1 module	3614	1/5/30
<b>6793 94</b>	IN Wall wireless shutter switch - 1 module	4166	1/5/30
<b>6793 92</b>	IN Wall Home/Away wireless switch - 1 module	4166	1/5/30
<b>6793 96</b>	IN Wall Wake up/Sleep wireless switch - 1 module	4166	1/5/30

#### Charcoal Grey Mechanism

##### Connected Light Switches

6793 74	Switch with neutral, wired, 1 module	9814	1/5/50
6793 75	Switch without neutral, with dimmer option, wired, 2 modules	12912	1/5/50
<b>6793 85</b>	Switch dimmer with neutral 150W, 1 module	7654	1/5/30
<b>6793 86</b>	Switch dimmer with neutral, wired, 2 modules	13062	1/5/30

### Charcoal Grey Mechanism Sockets, Regulators, Hospitality Function

Cat.Nos	Description	MRP* ₹ / Unit	Pack
---------	-------------	------------------	------

#### Connected Outlets

6793 82	Connected socket outlet module - 16A - 240VA - 3680 W, 1 module	10272	1/5/50
---------	---	-------	--------

#### Connected Curtain/Roller blind Switches

6793 76	Connected curtain/roller blind switch wired, 1 module	10566	1/5/50
---------	---	-------	--------

#### Connected gateway pack

6793 81	Connected gateway + Master home away wireless switch wired, 2 module	21572	1/5/20
---------	--	-------	--------

#### Connected wireless controls

6793 77	Wireless light switch	4754	1/5/30
6793 79	Curtain/roller blind wireless switch	5030	1/5/30
<b>6793 88</b>	2G Wireless switch, 2 Module	4784	1/5/30

#### Connected Wireless scene Switches

6793 78	Home/Away wireless master switch	5358	1/5/30
6793 80	Wake up/Sleep wireless switch	5482	1/5/30
<b>6793 84</b>	Wireless 4 scenario control switch, 2 module	5980	1/5/30

#### Micro module switch

6793 89	Micro module switch with neutral, 300 W	6508	1/5/50
---------	---	------	--------

#### IN Wall Wireless Switch

<b>6793 87</b>	IN Wall wireless light switch - 1 module	4154	1/5/30
<b>6793 95</b>	IN Wall wireless shutter switch - 1 module	4792	1/5/30
<b>6793 93</b>	IN Wall Home/Away wireless switch - 1 module	4792	1/5/30
<b>6793 97</b>	IN Wall Wake up/Sleep wireless switch - 1 module	4792	1/5/30

#### COVER PLATES

##### Plate Frame White

6795 01	PLATE+FRAME 1M WHITE	184	0/20/200
6795 02	PLATE+FRAME 2M WHITE	192	0/20/200
6795 03	PLATE+FRAME 3M WHITE	206	0/10/100
6795 04	PLATE+FRAME 4M WHITE	226	0/10/100
6795 06	PLATE+FRAME 6M WHITE	392	0/5/50
6795 08	PLATE+FRAME 8M WHITE	432	0/5/50
6795 09	PLATE+FRAME 2X4M WHITE	548	0/5/25
6795 10	PLATE+FRAME 9M WHITE	576	0/5/50
6795 12	PLATE+FRAME 12M WHITE	652	0/0/10
6795 16	PLATE+FRAME 16M WHITE	762	0/0/10

\* MRP - Maximum Retail Price Inclusive of all taxes including GST.  
■ Price available on request

Bold Cat.Nos are products normally available with Legrand (India) Stockists. Cat.Nos that are not bold - delivery within 4 - 8 weeks from the date of order. Bold packing quantity is our mandatory packing. Orders to be placed by Legrand (India) Stockist in multiples of the same.

**COVER PLATES**

Cat.Nos	Description	MRP ₹ / Unit	Pack
---------	-------------	--------------------	------

**COVER PLATES**
**Plate Frame White**

6795 18	PLATE+FRAME 18M WHITE	874	0/0/10
---------	-----------------------	-----	--------

**Plate Frame ICE WHITE**

6795 21	PLATE+FRAME 1M ICE WHITE	244	1/5/30
6795 22	PLATE+FRAME 2M ICE WHITE	260	1/5/30
6795 23	PLATE+FRAME 3M ICE WHITE	276	1/0/20
6795 24	PLATE+FRAME 4M ICE WHITE	296	1/0/20
6795 26	PLATE+FRAME 6M ICE WHITE	534	1/0/10
6795 28	PLATE+FRAME 8M ICE WHITE	582	1/0/10
6795 29	PLATE+FRAME 2X4M ICE WHITE	728	1/0/5
6795 32	PLATE+FRAME 12M ICE WHITE	882	1/0/5
6795 36	PLATE+FRAME 16M ICE WHITE	1028	1/0/5
6795 38	PLATE+FRAME 18M ICE WHITE	1180	1/0/5

**Plate Frame ICE BLACK**

6795 41	PLATE+FRAME 1M ICE BLACK	244	1/5/30
6795 42	PLATE+FRAME 2M ICE BLACK	260	1/5/30
6795 43	PLATE+FRAME 3M ICE BLACK	276	1/0/20
6795 44	PLATE+FRAME 4M ICE BLACK	296	1/0/20
6795 46	PLATE+FRAME 6M ICE BLACK	534	1/0/10
6795 48	PLATE+FRAME 8M ICE BLACK	582	1/0/10
6795 49	PLATE+FRAME 2X4M ICE BLACK	728	1/0/5
6795 52	PLATE+FRAME 12M ICE BLACK	882	1/0/5
6795 56	PLATE+FRAME 16M ICE BLACK	1028	1/0/5
679558	PLATE+FRAME 18M ICE BLACK	1180	1/0/5

**COVER PLATES**

Cat.Nos	Description	MRP ₹ / Unit	Pack
---------	-------------	--------------------	------

**Plate Frame PEARL CHAMPAGNE**

6795 61	PLATE+FRAME 1M PEARL CHAMPAGNE	336	1/5/30
6795 62	PLATE+FRAME 2M PEARL CHAMPAGNE	354	1/5/30
6795 63	PLATE+FRAME 3M PEARL CHAMPAGNE	374	1/0/20
6795 64	PLATE+FRAME 4M PEARL CHAMPAGNE	408	1/0/20
6795 66	PLATE+FRAME 6M PEARL CHAMPAGNE	728	1/0/10
6795 68	PLATE+FRAME 8M PEARL CHAMPAGNE	796	1/0/10
6795 69	PLATE+FRAME 2X4M PEARL CHAMPAGNE	996	1/0/5
6795 72	PLATE+FRAME 12M PEARL CHAMPAGNE	1204	1/0/5
6795 76	PLATE+FRAME 16M PEARL CHAMPAGNE	1402	1/0/5
6795 78	PLATE+FRAME 18M PEARL CHAMPAGNE	1612	1/0/5

**Plate Frame SONIC SILVER**

6795 81	PLATE+FRAME 1M SONIC SILVER	336	1/5/30
6795 82	PLATE+FRAME 2M SONIC SILVER	354	1/5/30
6795 83	PLATE+FRAME 3M SONIC SILVER	374	1/0/20
6795 84	PLATE+FRAME 4M SONIC SILVER	408	1/0/20
6795 86	PLATE+FRAME 6M SONIC SILVER	728	1/0/10

\* MRP - Maximum Retail Price Inclusive of all taxes including GST.

■ To be Introduced Shortly

(1) Supplied with white plate

■ Price available on request

Bold Cat.Nos are products normally available with Legrand (India) Stockists. Cat.Nos that are not bold - delivery within 4 - 8 weeks from the date of order. Bold packing quantity is our mandatory packing. Orders to be placed by Legrand (India) Stockist in multiples of the same.

**COVER PLATES**

Cat.Nos	Description	MRP ₹ / Unit	Pack
---------	-------------	--------------------	------

**Plate Frame SONIC SILVER**

6795 88	PLATE+FRAME 8M SONIC SILVER	796	1/0/10
6795 89	PLATE+FRAME 8M SONIC SILVER	996	1/0/5
6795 92	PLATE+FRAME 12M SONIC SILVER	1204	1/0/5
6795 96	PLATE+FRAME 16M SONIC SILVER	1402	1/0/5
6795 98	PLATE+FRAME 18M SONIC SILVER	1612	1/0/5

**Plate Frame DARK FADE**

6796 01	PLATE+FRAME 1M DARK FADE	336	1/5/30
6796 02	PLATE+FRAME 2M DARK FADE	354	1/5/30
6796 03	PLATE+FRAME 3M DARK FADE	374	1/0/20
6796 04	PLATE+FRAME 4M DARK FADE	408	1/0/20
6796 06	PLATE+FRAME 6M DARK FADE	728	1/0/10
6796 08	PLATE+FRAME 8M DARK FADE	796	1/0/10
6796 09	PLATE+FRAME 2X4M DARK FADE	996	1/0/5
6796 12	PLATE+FRAME 12M DARK FADE	1204	1/0/5
6796 16	PLATE+FRAME 16M DARK FADE	1402	1/0/5
6796 18	PLATE+FRAME 18M DARK FADE	1612	1/0/5

**COVER PLATES**

Cat.Nos	Description	MRP ₹ / Unit	Pack
---------	-------------	--------------------	------

**Plate Frame INTERLUDE**

6796 21	PLATE+FRAME 1M INTERLUDE	426	1/5/30
6796 22	PLATE+FRAME 2M INTERLUDE	448	1/5/30
6796 23	PLATE+FRAME 3M INTERLUDE	478	1/0/20
6796 24	PLATE+FRAME 4M INTERLUDE	518	1/0/20
6796 26	PLATE+FRAME 6M INTERLUDE	926	1/0/10
6796 28	PLATE+FRAME 8M INTERLUDE	1008	1/0/10
6796 29	PLATE+FRAME 2X4M INTERLUDE	1264	1/0/5
6796 32	PLATE+FRAME 12M INTERLUDE	1526	1/0/5
6796 36	PLATE+FRAME 16M INTERLUDE	1784	1/0/5
6796 38	PLATE+FRAME 18M INTERLUDE	2044	1/0/5

**Plate Frame TRINITY**

6796 41	PLATE+FRAME 1M TRINITY	426	1/5/30
6796 42	PLATE+FRAME 2M TRINITY	448	1/5/30
6796 43	PLATE+FRAME 3M TRINITY	478	1/0/20
6796 44	PLATE+FRAME 4M TRINITY	518	1/0/20
6796 46	PLATE+FRAME 6M TRINITY	926	1/0/10
6796 48	PLATE+FRAME 8M TRINITY	1008	1/0/10
6796 49	PLATE+FRAME 2X4M TRINITY	1264	1/0/5

\* MRP - Maximum Retail Price Inclusive of all taxes including GST.  
 ■ Price available on request

Bold Cat.Nos are products normally available with Legrand (India) Stockists.  
 Cat.Nos that are not bold - delivery within 4 - 8 weeks from the date of order.  
 Bold packing quantity is our mandatory packing. Orders to be placed by Legrand (India) Stockist in multiples of the same.

**COVER PLATES**

Cat.Nos	Description	MRP* ₹ / Unit	Pack
---------	-------------	------------------	------

**Plate Frame TRINITY**

6796 52	PLATE+FRAME 12M TRINITY	1526	1/0/5
6796 56	PLATE+FRAME 16M TRINITY	1784	1/0/5
6796 58	PLATE+FRAME 18M TRINITY	2044	1/0/5

**Plate Frame LUMINAR**

6796 61	PLATE+FRAME 1M LUMINAR	426	1/5/30
6796 62	PLATE+FRAME 2M LUMINAR	448	1/5/30
6796 63	PLATE+FRAME 3M LUMINAR	478	1/0/20
6796 64	PLATE+FRAME 4M LUMINAR	518	1/0/20
6796 66	PLATE+FRAME 6M LUMINAR	926	1/0/10
6796 68	PLATE+FRAME 8M LUMINAR	1008	1/0/10
6796 69	PLATE+FRAME 2X4M LUMINAR	1264	1/0/5
6796 72	PLATE+FRAME 12M LUMINAR	1526	1/0/5
6796 76	PLATE+FRAME 16M LUMINAR	1784	1/0/5
6796 78	PLATE+FRAME 18M LUMINAR	2044	1/0/5

**Plate Frame STELLAR**

6796 81	PLATE+FRAME 1M STELLAR	426	1/5/30
6796 82	PLATE+FRAME 2M STELLAR	448	1/5/30
6796 83	PLATE+FRAME 3M STELLAR	478	1/0/20
6796 84	PLATE+FRAME 4M STELLAR	518	1/0/20
6796 86	PLATE+FRAME 6M STELLAR	926	1/0/10

**COVER PLATES**

Cat.Nos	Description	MRP* ₹ / Unit	Pack
---------	-------------	------------------	------

**Plate Frame STELLAR**

6796 88	PLATE+FRAME 8M STELLAR	1008	1/0/10
6796 89	PLATE+FRAME 2X4M STELLAR	1264	1/0/5
6796 92	PLATE+FRAME 12M STELLAR	1526	1/0/5
6796 96	PLATE+FRAME 16M STELLAR	1784	1/0/5
6796 98	PLATE+FRAME 18M STELLAR	2044	1/0/5

**cover plates without frame  
Plate without frame#**

6795 05	PLATE 2M SQ WHITE	118	1/5/30
6795 25	PLATE 2M SQ ICE WHITE	242	1/5/30
6795 45	PLATE 2M SQ ICE BLACK	242	1/5/30
6795 65	PLATE 2M SQ PEARL CHAMPAGNE	340	1/5/30
6795 85	PLATE 2M SQ SONIC SILVER	340	1/5/30
679605	PLATE 2M SQ DARK FADE	340	1/5/30
6796 25	PLATE 2M SQ INTERLUDE	432	1/5/30
6796 45	PLATE 2M SQ TRINITY	432	1/5/30
6796 65	PLATE 2M SQ LUMINAR	432	1/5/30
6796 85	PLATE 2M SQ STELLAR	432	1/5/30

**Accessory**

0648 71	Pack of 3 x 4 extra removable stickers for fixing a wireless control	570	1/25
---------	--	-----	------

\* MRP - Maximum Retail Price Inclusive of all taxes including GST.

■ Price available on request

# Suitable only for wireless switch,

Bold Cat.Nos are products normally available with Legrand (India) Stockists. Cat.Nos that are not bold - delivery within 4 - 8 weeks from the date of order. Bold packing quantity is our mandatory packing. Orders to be placed by Legrand (India) Stockist in multiples of the same.



# Myrius™

## More is on.

MORE IS ON



The Myrius's range of plates is crafted with unique features & flawless designs, it perfectly defines aestheticism. These minimalistic and flawless designs are available in neutral tones of grainy matte black and glossy white to suit any décor.



### Black Beauty

A mystic black shade with a grainy matte finish truly complements any décor.

### Snowy White

Its gleaming white shade and a perfect glossy finish creates a soothing décor.



Scan to know more about the product.

## MORE AESTHETICS

Flat, sleek and smooth, Myrius with its curved edges gives it a distinct and appealing look to everyone. Moreover, its minimalistic design makes it look absolutely stunning and desirable. But what makes Myrius truly beautiful is a classic black and white shade that offers an aura of comfort and timelessness.



### VSP - Voltage Surge protectors

- Protects electrical devices like laptops, computers, printers and other office equipments from voltage surge
- Blends very well with the modular range of wiring devices



### Motion sensor

- Infrared detectors that detect human movements
- Programmed to automatically switch the device on and switch off when not in use, thus, saves energy



### Motor Starter

- Complete protection against overload
- Aesthetically appealing
- For ACs/Geysers etc.



### Skirting light

- Fitted into the walls at skirting level
- Provides a dim lighting
- Creates a path light during night
- Uses LEDs that saves energy



### Remote control switch for light and fan

- Can control 4 lights & 1 fan
- 10 different speed options for fan
- Night lamp on product panel with manual operation option for all functions

# Myrius™

More is on.

MORE IS ON



Myrius range of wiring accessories is a classic creation to increase the customer's comfort and improve the work environment. This wide range of innovative products offers solutions for residential, commercial and hospitality projects, thus making it a range that caters to everyone's needs.



Fan regulator



Light Marking



TV/SAT/FM socket



Telephone Socket



AV Connector



RJ 45 Data Socket



Projector connector



Key Fob Switch



Do not disturb Switch



Shaver socket



USB Charger



Modular MCB



## Myrius™ mechanisms - white

Cat.Nos	Description	MRP* ₹ / Unit	Pack
---------	-------------	------------------	------

### Switches - 6 A - 230 VA

6730 00	6 A switch 1 W - 1 module	150	20/200
6730 01	6 A switch 2 W - 1 module	242	20/200
6730 02	6 A switch 1 W - 1 module with indicator	226	20/200
6730 03	6 A switch 1 W - 1 module with "Light" marking	194	20/200
6730 04	6 A switch 1 W - 1 module with "Fan" marking	198	20/200

### Switches - 10 A - 230 VA

6730 05	10 A switch 1 W - 2 module	284	10/100
6730 06	10 A switch 2 W - 2 module	332	10/100
6730 17	10 A intermediate - 2 module	1870	10/100
6730 07	10 A switch 1 W with indicator - 2 module	354	10/100

### Switches - 16 A - 230 VA

6730 08	16 A switch 1 W - 1 module	324	20/200
6730 09	16 A switch 2 W - 1 module	374	20/200
6730 10	16 A switch 1 W with indicator - 1 module	394	20/200

### Switches - 20 A - 230 VA

6730 11	20 A 1 W switch - 1 module	426	20/200
6730 12	20 A DP 1 W switch - 2 module	646	10/100
6730 13	20 A DP 1 W switch with indicator - 2 module	688	10/100
6730 14	20 A 2 W switch - 2 module	718	10/100

### Switches - 25 A - 230 VA

6730 15	25 A SP 1 W switch with indicator - 1 module	476	20/200
---------	--	-----	--------

### Switches - 32 A - 230 VA

6730 16	32 A DP switch with indicator - 2 module	1114	10/100
---------	--	------	--------

\* MRP - Maximum Retail Price Inclusive of all taxes including GST.

## Myrius™ mechanisms - white

Cat.Nos	Description	MRP* ₹ / Unit	Pack
---------	-------------	------------------	------

### Push buttons

6730 18	6 A push button SP - 1 module	278	20/200
6730 19	6 A push button SP with indicator - 1 module	360	20/200
6730 20	6 A bell push - 1 module	268	20/200
6730 21	6 A bell push with indicator - 1 module	354	20/200
6730 22	6 A bell push - 2 module	406	10/100
6730 23	6 A bell push with indicator - 2 module	476	10/100

### Accessories for switches with indicator

6732 44	Lamp for switches / push buttons	66	5/50
---------	----------------------------------	----	------

### Socket - 230 VA

6730 41	6/16 A 2 Pin Euro US socket - 1 module	382	20/200
6730 42	16 A 3 Pin switched socket - 3 module	1228	5/50
6730 43	Multistandard socket 6/10/13 A - 2/3 pin for 250 V AC 15 A for 127 V type - 2 pin 2 module	412	10/100
6730 44	6 A 5 Pin universal socket - 2 module	354	20/200
6730 83	6/16 A socket - 3 module	584	5/50
6730 45	6/16 A socket - 2 module	490	10/100
6730 46	6/16 A - Euro socket - 2 module	560	10/100
6730 47	25 A socket - 2 module	606	10/100
<b>6731 86</b>	6A 3 Pin ISI socket - 2 module	240	1/20/200

### Power unit

6730 74	Power strip - 8 module 6 A (2 nos.) + 16 A socket (1 no.) + 16 A switch with indicator (1 no.)	2820	1/10
6730 75	Power strip - 8 module 5 Pin 6 A (3 nos.) + 16 A switch with indicator (1 no.)	2214	1/10
6730 76	Power strip - 8 module multistd socket (3 nos.) + 16 A switch (1 no.)	2182	1/10

Bold Cat.Nos are products normally available with Legrand (India) Stockists. Cat.Nos that are not bold - delivery within 4 - 8 weeks from the date of order. Bold packing quantity is our mandatory packing. Orders to be placed by Legrand (India) Stockist in multiples of the same.

## Myrius™ mechanisms - white

Cat.Nos	Description	MRP* ₹ / Unit	Pack
---------	-------------	------------------	------

### Dimmer & regulator

6730 24	Rotary dimmer 400 W - 1 module	1192	1/5/50
6730 25	Rotary dimmer 650 W - 3 module	2508	1/10
6730 26	Compact fluorescent lamp dimmer - 2 module	3918	1/10
6730 27	Fan step regulator 100 W - 1 module	920	1/5/50
6730 29	Fan step regulator 100 W - 2 module	1058	1/10/100
6730 28	Fan step regulator 120 W - 2 module	1138	1/10/100
6730 77	Fan step regulator - 2 module for energy saving fans	1112	1/10/100

### Emergency light

0785 12	Emergency light unit - 2 module	6186	1/1
---------	---------------------------------	------	-----

### Indicators

0785 73	Triangular bulkhead - Blue - 2 module	310	1/1
0785 71	Triangular bulkhead - colourless - 2 module	310	1/1
0785 72	Triangular bulkhead - green - 2 module	342	1/1
0785 70	Triangular bulkhead - red - 2 module	342	1/1

### Skirting light

6730 36	Skirting light with white LED - 3 module	920	1/5/25
---------	--	-----	--------

### Bell indicator

6730 33	Bell indicator - 240 VA - 1 module	1284	20/200
---------	------------------------------------	------	--------

### Buzzer

6730 34	Buzzer - 230 VA - 1 module	1264	20/200
---------	----------------------------	------	--------

### Remote unit

6730 73	Remote control switch - 4 module	9310	1/5/20
---------	----------------------------------	------	--------

### Hospitality functions Key FOB switch

6730 37	15 A key card switch monobloc with plate - 2 M	4316	1/10
6732 37	15 A key card switch monobloc with new plate - 2M White	4970	1/10
6730 38	Only key fob for switch Cat.Nos 6730 37 & 6732 37	204	1/10/100

\* MRP - Maximum Retail Price Inclusive of all taxes including GST.  
 \* To be Introduced Shortly

## Myrius™ mechanisms - white

Cat.Nos	Description	MRP* ₹ / Unit	Pack
---------	-------------	------------------	------

### "Do Not Distrub" and MMR control unit

6730 39	External unit - 1+1 module	1840	10/100
6730 40	Internal unit - 1+1 module	1230	10/100

### Shaver socket

6730 49	Shaver Socket 230 V / 120 - 230 V monobloc with plate - 4 M	5478	1/5/20
6730 79	Shaver Socket 230 V / 120 - 230 V monobloc with new plate - 4 M White	5744	1/5

### Sockets and connectors

#### TV socket

6730 50	TV socket - 1 module	236	20/200
---------	----------------------	-----	--------

#### Data & voice

6730 52	RJ-11 telephone socket with transparent shutter 1 module	232	20/200
6730 53	RJ-11 double telephone socket with shutter 1 module	360	20/200
6730 54	UTP cat 5e information outlets toolless system 1 module	562	20/200
6730 55	UTP cat 6 - 1 module	836	20/200
6730 56	UTP cat 6 - 2 module	848	10/100

#### USB chargers (IS13252 (Part 1) / IEC 60950-1)

6731 62	*USB charger 1M 1500mA	1716	10/100
6731 78	Double USB charger 2M 2400mA	2404	1/10/100

#### Combi (USB + Socket)

<b>6731 84</b>	Combi Twin USB 3.1A Euro Socket type A-2 module	2052	1/10/100
<b>6731 85</b>	Combi Twin USB 3.1A Euro Socket type A & type C-2 module	2462	1/10/100

#### Audio & video connector

6730 57	3 x female RCA 1 module 1 module	3220	1/10
---------	----------------------------------	------	------

#### Sound (Volume controller)

6730 63	Suitable for 8 Ohms, 3W (RNS) speaker - 2	1538	1/10/100
---------	---	------	----------

#### Protectors and accessories Motor starter

6730 30	16A motor starter 2 module	754	1/10/100
6730 31	25A motor starter 2 module	772	1/10/100

Bold Cat.Nos are products normally available with Legrand (India) Stockists. Cat.Nos that are not bold - delivery within 4 - 8 weeks from the date of order. Bold packing quantity is our mandatory packing. Orders to be placed by Legrand (India) Stockist in multiples of the same.

## Myrius™ mechanisms - white

Cat.Nos	Description	MRP* ₹ / Unit	Pack
---------	-------------	---------------------	------

### Modular MCB (IS : 60898-1:2002)

6730 64	16A MCB SP 1M C curve	448	1/10/100
6730 65	20A MCB SP 1M C curve	448	1/10/100
6732 05	25A MCB SP 1M C curve	448	1/10/100
6732 07	32A MCB SP 1M C curve	448	1/10/100

### RCBO

6730 78	Single pole + Neutral - 30 mA, 16 A - 230 VA 2 module	10048	1/1
---------	---	-------	-----

### Accessories

6730 60	Cable outlet - 8 mm 1 module	288	20/200
6730 61	Blanking plate - 1 module	62	20/200
6730 62	Blanking plate - 2 module	70	10/100
0802 90	Panel mounting support 1 module	252	10/200
0802 91	Panel mounting support 2 module	264	10/200

### Myrius antibacterial switches & accessories - white

6730 84	6 A switch 1 W - 1 module	222	20/200
6730 85	6 A switch 2 W - 1 module	294	20/200
6730 86	6 A bell push - 1 module	330	20/200
6730 89	16 A switch 1 way - 1 module	394	20/200
6730 90	16 A switch 2 way - 1 module	454	20/200
6730 92	Fan regulator 120 W - 2 module	1434	1/10/100
6730 93	Multistandard socket - 2 module	502	10/100
6730 94	6 A 5 pin universal socket 2 module	434	20/200
6730 95	6/16 A socket - 3 module	706	5/50
<b>6731 87</b>	<b>6A 3-Pin ISI socket - 2 module</b>	<b>300</b>	<b>1/20/200</b>
0787 00	Equipotential socket 1 module antibacterial	1898	1/10
6730 98	T.V. socket - 1 module	290	20/200
6730 99	RJ -11 telephone socket - 1 module	290	20/200
6730 81	RJ-45 Cat 6 UTP - 1 module	1028	20/200
6730 82	Blanking plate - 1 module	54	20/200
6732 45	1 module plate + frame 1 module	218	20/200
6732 46	2 module plate + frame 2 module	244	20/200

**NEW!**

# Myrius™ More is on. ANTI-BACTERIAL

## MORE FOR YOUR WELLNESS



Myrius anti-bacterial products offer anti-bacterial protection. The composition of the product contain Ag+ ions that eliminates the proliferation of bacteria on contact with the surface of the product. It has a smooth and straight design that facilitates in reducing the dust accumulation. It is self disinfecting throughout its lifespan.

- Extremely useful in agri-food premises, healthcare environments & premises with high risk in terms of people's fragility.
- Special protection for the health and hygiene market in the form of an equipotential socket for earthing devices, application to connection of hospital beds and trolleys to medical apparatus to avoid all risk of potential difference during the medical care.



Scan to know more about  
the product.

\* MRP - Maximum Retail Price Inclusive of all taxes including GST.

## Myrius™ mechanisms - black

Cat.Nos	Description	MRP* ₹ / Unit	Pack
---------	-------------	------------------	------

### accessories - white

6732 47	3 module plate + frame 3 module	276	10/100
6732 48	4 module plate + frame 4 module	298	10/100
6732 49	8 module plate + frame (horizontal) 8 module	572	5/50
6732 50	8 module plate + frame (4x2) 8 module	720	5/25
6732 52	16 module plate + frame 16 module	1000	1/10

### Switches – 6 A - 230 VA

6731 00	6 A switch 1 W 1 module	186	20/200
6731 01	6 A switch 2 W 1 module	278	20/200
6731 02	6 A switch 1 W with indicator - 1 module	306	20/200
6731 03	6 A switch 1 W with "Light" marking 1 module	234	20/200
6731 04	6 A switch 1 W with "Fan" marking 1 module	236	20/200

### Switches – 10 A - 230 VA

6731 05	10 A switch 1 W 2 module	350	10/100
6731 06	10 A switch 2 W 2 module	374	10/100
6731 17	10 A intermediate switch 2 module	2156	10/100
6731 07	10 A switch 1 W with indicator - 2 module	402	10/100

### Switches – 16 A - 230 VA

6731 08	16 A switch 1 way 1 module	366	20/200
6731 09	16 A switch 2 way 1 module	438	20/200
6731 10	16 A switch 1 way with indicator - 1 module	454	20/200

### Switches – 20 A - 230 VA

6731 11	20 A 1 W switch 1 module	490	20/200
6731 12	20 A DP 1 W switch 2 module	766	10/100
6731 13	20 A DP 1 W switch with indicator - 2 module	808	10/100
6731 14	20 A 2 W switch 2 module	840	10/100

\* MRP - Maximum Retail Price Inclusive of all taxes including GST.

## Myrius™ mechanisms - black

Cat.Nos	Description	MRP* ₹ / Unit	Pack
---------	-------------	------------------	------

### Switches – 25 A - 230 VA

6731 15	25 A SP 1 W switch with indicator - 1 module	558	20/200
---------	---	-----	--------

### Switches – 32 A - 230 VA

6731 16	32 A DP switch with indicator - 2 module	1290	10/100
---------	--	------	--------

### Push buttons

6731 18	6 A push button SP 1 module	322	20/200
6731 19	6 A push button SP with indicator - 1 module	408	20/200
6731 20	6 A bell push - 1 module	306	20/200
6731 21	6 A bell push with indicator - 1 module	408	20/200
6731 22	6 A bell push 2 module	470	10/100
6731 23	6 A bell push with indicator - 2 module	558	10/100

### Accessories for switches with indicator

6732 44	Lamp for switches / push buttons	66	5/50
---------	-------------------------------------	----	------

### Socket - black

6731 41	6/16 A 2 pin Euro US socket - 1 module	442	20/200
6731 42	16 A 3 pin switched socket - 3 module	1428	5/50
6731 43	Multistandard socket 6/10/13 A - 2/3 pin for 250 V AC 15 A for 127 V type - 2 pin 2 module	490	10/100
6731 44	6 A 5 Pin with universal socket 2 module	394	20/200
6731 83	6/16 A socket 3 module	676	5/50
6731 45	6/16 A socket 2 module	572	10/100
6731 47	25 A socket - 2 module	702	10/100
<b>6721 03</b>	6A 3 Pin ISI socket - 2 module	270	1/20/200

### Socket - red

6730 48	16 A switched socket 3 module	1266	5/50
---------	----------------------------------	------	------

### Dimmers & regulators

6731 24	Rotary dimmer 400 W 1 module	1366	1/5/50
6731 25	Rotary dimmer 650 W 3 module	2894	1/10
6731 27	Fan step regulator 100 W 1 module	1082	1/5/50

Bold Cat.Nos are products normally available with Legrand (India) Stockists. Cat.Nos that are not bold - delivery within 4 - 8 weeks from the date of order. Bold packing quantity is our mandatory packing. Orders to be placed by Legrand (India) Stockist in multiples of the same.



6731 01



6731 02



6731 05



6731 10



6731 12



6731 15



6731 21



6731 22



6731 41



6731 42



6731 44



6730 48

NEW!



6731 25



6731 27



## Myrius™ mechanisms - black

Cat.Nos	Description	MRP* ₹ / Unit	Pack
---------	-------------	---------------------	------

### Dimmers & regulators

6731 29	Fan step regulator 100 W 2 module	1228	1/10/100
6731 28	Fan step regulator 120 W 2 module	1348	1/10/100
6731 77	Fan step regulator - 2 module for energy saving fans	1300	1/10/100

### Skirting light

6731 36	Skirting light with white LED - 3 module	1062	1/5/25
---------	---	------	--------

### Bell indicator

6731 33	Bell Indicator- 240 VA 1 module	1524	20/200
---------	------------------------------------	------	--------

### Buzzer

6731 34	Buzzer - 230 VA sound level 72dB at 1 meter distance 1 module	1480	20/200
---------	---	------	--------

### Remote unit

6731 73	Remote control switch 4 module	10808	1/5/20
---------	-----------------------------------	-------	--------

### Hospitality functions Key FOB switch

6731 37	15 A key card switch with timedelay 30 sec. monobloc with plate - 2 M	4958	1/10
6732 67	15 A key card switch monobloc with new plate - 2 M Black	5784	1/10
6730 38	Only key fob for switch Cat.No 6731 37 & 6732 67	204	1/10/100

### "Do Not Distrub" and MMR control unit

6731 39	External unit - 1+1 module	2108	10/100
6731 40	Internal unit - 1+1 module	1410	10/100

### Shaver socket

6731 49	Shaver socket 220/240 V - 50/60 Hz monobloc with plate - 4 M	6006	1/5/20
6731 79	Shaver socket 230 V / 120 - 230 V monobloc with new plate - 4 M Black	6320	1/5

### TV socket

6731 50	TV socket - 1 module	290	20/200
---------	----------------------	-----	--------

### Data & voice

6731 52	RJ-11 telephone socket with transparent shutter 1 module	278	20/200
6731 53	RJ-11 double telephone socket with shutter 1 module	426	20/200

## Myrius™ mechanisms - black

Cat.Nos	Description	MRP* ₹ / Unit	Pack
---------	-------------	---------------------	------

### Data & voice

6731 54	UTP cat 5e RJ 45 information outlets 1 module	620	20/200
6731 55	UTP cat 6 - 1 module	942	20/200
6731 56	UTP cat 6 - 2 module	950	10/100

### USB chargers (IS13252 (Part 1) / IEC 60950-1)

6731 72	*USB Charger 1M 1500mA	1976	10/100
6732 78	Double USB charger 2M 2400mA	2766	1/10/100

### Combi (USB + Socket)

<b>6721 01</b>	Combi Twin USB 3.1A Euro Socket type A-2 module	2358	1/10/100
<b>6721 02</b>	Combi Twin USB 3.1A Euro Socket type A & type C-2 module	2830	1/10/100

### Connectors and controllers

#### Audio & video connector

6731 57	3 x female RCA -1 module	3706	1/10
6731 58	3 pole XLR sockets 2 module	3496	10/100

### Sound

6731 63	Suitable for 8 Ohms, 8 Ohms, 3 Watts (RNS) speaker - 2 module	1784	1/10/100
---------	---	------	----------

### Protectors and accessories

#### Motor starter

6731 30	16 A motor starter- 2 module	884	1/10/100
6731 31	25 A motor starter- 2 module	904	1/10/100

#### Modular MCB (IS : 60898-1:2002)

6731 64	16A MCB SP 1M C curve	516	1/10/100
6731 65	20A MCB SP 1M C curve	516	1/10/100

### Accessories

6731 60	Cable outlet - 8mm 1 module	350	20/200
6731 61	Blanking plate-1 module	68	20/200

### Plastic plates

#### White plates with frame

6732 01	1 Module plate + Frame	210	20/200
6732 02	2 Module plate + Frame	224	20/200
6732 03	3 Module plate + Frame	238	10/100
6732 04	4 Module plate + Frame	256	10/100
6732 06	6 Module plate + Frame	460	5/50
6732 08	8 Module plate + Frame (horizontal)	504	5/50
6732 09	8 Module plate + Frame (4x2)	628	5/25
6732 12	12 Module plate + Frame	762	1/10
6732 16	16 Module plate + Frame	880	1/10
6732 18	18 Module plate + Frame	1016	1/10

Bold Cat.Nos are products normally available with Legrand (India) Stockists. Cat.Nos that are not bold - delivery within 4 - 8 weeks from the date of order. Bold packing quantity is our mandatory packing. Orders to be placed by Legrand (India) Stockist in multiples of the same.



6731 36



6731 33



6731 34



6731 40



6731 50



6731 52



6731 63



6732 01



6732 03



## Myrius™ plastic plates



Cat.Nos	Description	MRP* ₹ / Unit	Pack
---------	-------------	------------------	------

### New white plates with frame\*

6732 11	1 Module plate + Frame	216	20/200
6732 42	2 Module plate + Frame	230	20/200
6732 13	3 Module plate + Frame	250	10/100
6732 14	4 Module plate + Frame	264	10/100
6732 66	6 Module plate + Frame	516	5/50
6732 68	8 Module plate + Frame (Horizontal)	552	5/50
6732 69	8 Module plate + Frame (4x2)	694	5/25
6732 62	12 Module plate + Frame	838	1/10
6732 56	16 Module plate + Frame	978	1/10
6732 58	18 Module plate + Frame	1122	1/10

### Black plates with frame

6732 21	1 Module plate + Frame	358	20/200
6732 22	2 Module plate + Frame	384	20/200
6732 23	3 Module plate + Frame	408	10/100
6732 24	4 Module plate + Frame	456	10/100
6732 26	6 Module plate + Frame	788	5/50
6732 28	8 Module plate + Frame (Horizontal)	878	5/50
6732 29	8 Module plate + Frame (4 x 2)	1084	5/25
6732 32	12 Module plate + Frame	1292	1/10
6732 36	16 Module plate + Frame	1516	1/10
6732 38	18 Module plate + Frame	1716	1/10

### New black plates with frame\*

6732 31	1 Module plate + Frame	406	20/200
6732 82	2 Module plate + Frame	446	20/200
6732 33	3 Module plate + Frame	476	10/100
6732 34	4 Module plate + Frame	516	10/100
6732 86	6 Module plate + Frame	912	5/50
6732 88	8 Module plate + Frame (Horizontal)	994	5/50
6732 89	8 Module plate + Frame (4 x 2)	1246	5/25
6732 92	12 Module plate + Frame	1498	1/10
6732 96	16 Module plate + Frame	1744	1/10
6732 98	18 Module plate + Frame	1968	1/10

### Mounting boxes

#### Flush mounting boxes

6890 07	Flush box - 1/2 module	138	40
6890 08	Flush box - 3 module	138	40
6890 09	Flush box - 4 module	184	40

\* MRP - Maximum Retail Price Inclusive of all taxes including GST.  
# The new plate range will be introduced shortly.

Cat.Nos	Description	MRP* ₹ / Unit	Pack
---------	-------------	------------------	------

### Flush mounting boxes

6890 10	Flush box - 6 module	288	40
6890 42	Flush box - 8 module	338	40
6890 31	Flush box - 8 module (2 row x 4)	336	20
6890 11	Flush box - 12/16 (2 row x 6) module (metal box)	508	10
6890 12	Flush box - 18 module (metal box)	640	10

### Surface mounting boxes

6733 02	Surface box - 1/2 module	88	10/50
6733 03	Surface box - 3 module	102	5/35
6733 04	Surface box - 4 module	118	5/25
6733 06	Surface box - 6 module	154	1/10
6733 08	Surface box - 8 module	230	1/5
6733 05	Surface box - 8 (2 row x 4) module	218	1/5

### Metal surface boxes

6890 21	Metal surface box - 12/16 (2 row x 6) module	542	1/6
6890 22	Metal surface box - 18 module	568	1/4

## Myrius™ More is on.

### Guarantee

- The Company, at its discretion, will replace products if they have any manufacturing defect within 10 years for switches (without LED lamp) and power sockets. For all other Myrius™ wiring accessories the guarantee will be 2 years.
- The above guarantee is applicable when the devices are used in Legrand metal flush boxes. Otherwise the guarantee period will be reduced by 50%.
- The guarantee is only applicable when the products are installed as per the Company's instructions and not tampered in any manner.
- The guarantee states the Company's entire liability. It does not extend to cover consequential loss or damage or installation costs arising from defective products.

\* MRP - Maximum Retail Price Inclusive of all taxes including GST.  
# The new plate range will be introduced shortly.

# Mylinc™

A little touch of genius

## A LITTLE TOUCH OF GENIUS

Mylinc™ is a complete range of modular wiring accessories. Switches and sockets designed and made in India, keeping everyone's requirements in mind. Whether it's safety, reliability, convenience or beauty; Mylinc™ is the smart option in modular switch design.



Remote control unit for Light and Fan



USB Charger



8 Step Fan Regulator



Modular MCB



Champagne



Silver Alu



Scan to know more about the product.



Dark Bronze



Matt Grey



Pearl White



Motor Starter



Skirting Light 2 M



Switch 25 A with indicator

# Mylinec™

A little touch of genius

## A LITTLE TOUCH OF GENIUS



Screwless finish & rounded corners that add beauty to any home



Linc-Loc™ intelligent design prevents wrong fitting, misaligned switches and sockets



Laser marking safeguards against fakes



Safety feature for mishap-proof use



Indicators for correct orientation



Front Removal



Stripping Template



ISI marking



CE marking

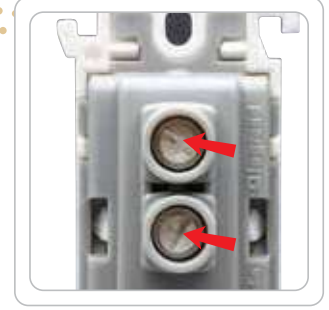

Finger-proof terminals for IP 20 protection against accidental contact

1 lac operations

with a guarantee of 100,000 operations, assuming an average switch is operated 10 times a day, this product is dependable for 27 years.

## Mylic™ mechanisms

Cat.Nos	Description	MRP* ₹ / Unit	Pack
---------	-------------	------------------	------

### Switches and accessories

#### Switches 6 A - 250 V AC

6755 01	6 A one-way SP switch - <b>1 module</b>	98	20/400
6755 02	6 A two-way SP switch - <b>1 module</b>	188	20/200
6755 03	6 A one-way SP switch with indicator - <b>1 module</b>	212	20/200

#### Switches 16 A - 250 V AC

6755 11	16 A one-way SP switch - <b>1 module</b>	210	20/200
6755 12	16 A two-way SP switch - <b>1 module</b>	262	20/200
6755 13	16 A one-way SP switch with indicator - <b>1 module</b>	270	20/200

#### Switch 25 A - 250 V AC

6759 68	Switch 25 A with indicator - <b>1 module</b>	322	10/100
---------	--	-----	--------

#### Switches 32 A - 250 V AC

6755 26	32 A one-way double pole switch with indicator - <b>2 module</b>	626	10/100
---------	--	-----	--------

#### Push buttons 6 A - 250 V AC

6755 04	6 A one-way SP bell push - <b>1 module</b>	194	20/200
6755 06	6 A one-way SP bell push with indicator - <b>2 module</b>	384	10/100

#### Bell call indicator & register - 6 A - 250 V AC

6755 07	Bell call Indicator with register - 6 A - one-way - SP - <b>1 module</b>	1036	20/200
---------	--	------	--------

#### Lighting modules

6755 95	Indicator light red - <b>1 module</b>	240	20/200
6755 96	Indicator light orange - <b>1 module</b>	240	20/200
6755 97	Skirting light with white LED - <b>3 module</b>	784	1/5/25
6759 76	Skirting light with white LED - <b>2 module</b>	524	5/50

#### Dimmers and fan regulators

6755 35	Rotative dimmer 60 - 250 W for light - <b>2 module</b>	650	1/10/100
6755 33	Mylic dimmer 400 W for light - <b>1 module</b>	826	1/5/50
6759 64	Fan regulator 100 W with 360° rotation - <b>2 module</b>	736	10/100
6755 30	Fan regulator 100 W, Humfree, 0-4 steps - <b>2 module</b>	792	1/10/100
6755 31	Fan regulator 100 W, Humfree, 0-4 steps - <b>1 module</b>	594	1/5/50
6759 77	Fan regulator 8 steps - <b>2 module</b>	792	1/10/100

## Mylic™ mechanisms

Cat.Nos	Description	MRP* ₹ / Unit	Pack
---------	-------------	------------------	------

### Buzzer

6755 40	Mylic buzzer	694	20/200
---------	--------------	-----	--------

### Remote unit

6759 75	Remote control unit with remote for 4 switch & fan load 4 m	3642	1/5/20
---------	---	------	--------

### DND & MMR

#### Indicator lamp

6755 56	DND & MMR external unit with bellpush 3 m	370	10/50
6759 69	DND & MMR external unit with bellpush 1+1 - 2 m	370	10/100
6755 57	Mylic internal control unit for DND & MMR	308	10/100

### Hotel key fob switch

6755 60	Hotel key fob switch - monobloc	3356	1/10
6730 38	Only key fob for 6755 60	204	1/10

### Energy sockets / power unit

#### Energy sockets

6755 50	6 A - 2/3 pin combine - <b>2 module</b>	222	20/200
6755 55	6/16 A - 3 pin combine - <b>2 module</b>	364	10/100
6755 51	6 A - 3 pin - <b>2 module</b>	240	10/100
6755 52	Universal socket 6 A - 2/3 pin combine - <b>2 module</b>	270	10/100
6755 53	Euro US socket 6/16 A - 2 pin, <b>1 module</b>	342	20/200
6755 54	6/10/13 A - multistandard socket - <b>2 Module</b>	364	10/100

#### Power unit

6755 58	Power unit for 2 ton A.C and 3.5 KW geyser - <b>4 module</b>	1282	5/25
---------	--	------	------

### Motor starter

6759 65	Motor starter 16 A 2 m	600	1/10/100
---------	------------------------	-----	----------

### Modular MCB (IS : 60898-1:2002)

6759 74	Modular SP MCB 16 A 1 m	418	1/10/100
6756 40	Modular SP MCB 20 A 1 m	418	1/10/100
6756 41	Modular SP MCB 25 A 1 m	418	1/10/100
6756 42	Modular SP MCB 32 A 1 m	418	1/10/100

### Low voltage sockets / TV socket and RJ11 telephone socket / accessories

6755 46	TV socket <b>1 module</b>	196	20/200
6755 41	RJ 11 telephone socket <b>1 module</b>	184	20/200
6755 44	Double RJ 11 telephone socket <b>1 module</b>	310	20/200
6759 66	RJ45 socket cat 5e with shutter - <b>1 module</b>	506	20/200
6759 67	RJ45 socket cat 6 with shutter - <b>1 module</b>	698	20/200

\* MRP - Maximum Retail Price Inclusive of all taxes including GST.

Bold Cat.Nos are products normally available with Legrand (India) Stockists. Cat.Nos that are not bold - delivery within 4 - 8 weeks from the date of order. Bold packing quantity is our mandatory packing. Orders to be placed by Legrand (India) Stockist in multiples of the same.



## Mylic™ mechanisms

Cat.Nos	Description	MRP* ₹ / Unit	Pack
---------	-------------	------------------	------

### USB chargers (IS13252(Part 1) / IEC 60950-1)

6759 71	USB charger - <b>1 module</b>	962	10/100
<b>6758 20*</b>	USB charger <b>1M 1500MA</b>	1054	10/100
6759 72	Double USB charger - <b>2 module</b>	1588	10/100

### Accessories

<b>6755 91</b>	Cable outlet - <b>1 module</b>	172	<b>20/200</b>
<b>6755 90</b>	Blanking plate 0.8 mm - <b>1 module</b>	48	<b>20/200</b>
6755 92	Spare 12 screws with nuts	62	<b>20/200</b>

### Mylic™ plates

#### Modular white plates with frame

<b>6755 61</b>	1 module plate - white	138	<b>20/200</b>
<b>6755 62</b>	2 modules plate - white	138	<b>20/200</b>
<b>6755 63</b>	3 modules plate - white	184	<b>10/100</b>
<b>6755 64</b>	4 modules plate - white	208	<b>10/100</b>
<b>6755 66</b>	6 modules plate - white	258	<b>5/50</b>
<b>6755 67</b>	8 modules horizontal - white	330	<b>5/50</b>
<b>6755 68</b>	4x2 modules plate - white	336	<b>5/25</b>
6755 69	9 modules plate- white	394	<b>5/50</b>
6755 72	12 modules plate - white	480	<b>10</b>
6755 73	16 modules plate - white	564	<b>10</b>
6755 78	18 modules plate - white	752	<b>10</b>

## Mylic™ mechanism matt grey

### Switches and accessories

#### Switches 6 A - 250 V AC

6763 01	6 A one-way SP switch - <b>1 module</b>	118	<b>20/200</b>
6763 02	6 A two-way SP switch - <b>1 module</b>	202	<b>20/200</b>
6763 03	6 A one-way SP switch with indicator - <b>1 module</b>	238	<b>20/200</b>

#### Switches 16 A - 250 V AC

6763 11	16 A one-way SP switch <b>1 module</b>	230	<b>20/200</b>
6763 12	16 A two-way SP switch <b>1 module</b>	284	<b>20/200</b>
6763 13	16 A one-way SP switch with indicator <b>1 module</b>	310	<b>20/200</b>

#### Switch 25 A - 250V AC

6763 41	Switch 25 A with indicator - <b>1 module</b>	358	<b>10/100</b>
---------	---	-----	---------------

#### Switches 32 A - 250V AC

6763 26	32 A one-way double pole switch with indicator - <b>2 module</b>	694	<b>20/200</b>
---------	--	-----	---------------

#### Push buttons 6 A - 250 V AC

6763 04	6 A one-way SP bell push <b>1 module</b>	204	<b>20/200</b>
6763 06	6 A one-way SP bell push with indicator <b>2 module</b>	424	<b>10/100</b>

\* MRP - Maximum Retail Price Inclusive of all taxes including GST.  
\* To be Introduced Shortly

## Mylic™ mechanism matt grey

Cat.Nos	Description	MRP* ₹ / Unit	Pack
---------	-------------	------------------	------

### Bell call indicator & register - 6 A - 250 V AC

6763 07	Bell call indicator with register - 6 A - one way <b>1 module</b>	1142	<b>20/200</b>
---------	---	------	---------------

### Lighting modules

6763 14	Indicator light red <b>1 module</b>	264	<b>20/200</b>
6763 15	Indicator light orange <b>1 module</b>	264	<b>20/200</b>
6763 16	Skirting light with white LED - <b>3 module</b>	856	1/5/25
6763 10	Skirting light with white LED - <b>2 module</b>	580	5/50

### Dimmers and fan regulators

6763 17	Rotative dimmer 60 - 250 W for light <b>2 module</b>	718	1/10/100
6763 18	Rotative dimmer 60 - 400 W <b>1 module</b>	912	1/5/50
6763 37	Fan regulator 100 W, with 360° rotation <b>2 module</b>	808	10/100
6763 19	Fan regulator 4 step <b>2 module</b>	872	1/10/100
6763 20	Fan regulator 4 step <b>1 module</b>	650	1/5/50
6763 08	Fan regulator 8 step <b>2 module</b>	868	1/10/100

### Buzzer

6763 21	Mylic buzzer	760	<b>20/200</b>
---------	--------------	-----	---------------

### Remote unit

6763 47	Remote control unit with remote for 4 switch & fan load 4 m	4010	1/5/20
---------	---	------	--------

### DND & MMR

#### Indicator lamp

6763 42	DND & MMR external unit with bellpush 1+1	406	<b>10/100</b>
6763 23	Mylic internal control unit for DND & MMR	336	<b>10/100</b>

### Hotel key fob switch

6730 38	Only key fob for 6755 60	204	1/10
6763 24	Hotel key fob switch monobloc	3720	1/10

### Energy sockets / power unit

#### Energy sockets

6763 25	6 A - 2/3 pin combined	244	<b>20/200</b>
6763 05	6/16A - 3 pin Combined <b>2 module</b>	392	<b>10/100</b>
6763 27	6 A - 3 pin - <b>2 module</b>	262	<b>10/100</b>
6763 28	Universal socket 6A-2/3 pin combined <b>2 module</b>	306	<b>10/100</b>

Bold Cat.Nos are products normally available with Legrand (India) Stockists.  
Cat.Nos that are not bold - delivery within 4 - 8 weeks from the date of order.  
Bold packing quantity is our mandatory packing. Orders to be placed by  
Legrand (India) Stockist in multiples of the same.

## Mylic™ mechanism matt grey

Cat.Nos	Description	MRP* ₹ / Unit	Pack
---------	-------------	------------------	------

### Energy sockets / power unit

#### Energy sockets

6763 29	Euro US socket 6/16A - 2 pin <b>1 module</b>	378	<b>20/200</b>
6763 30	6/10/13 A - Multistandard socket <b>2 module</b>	392	<b>10/100</b>

#### Power unit

6763 31	Power unit for 2 ton A.C and 3.5 KW geyser - <b>4 module</b>	1450	5/25
---------	--	------	------

#### Motor starter

6763 38	Motor starter 16 A 2 m	664	1/10/100
---------	------------------------	-----	----------

#### Modular MCB (IS : 60898-1:2002)

6763 46	Modular SP MCB 16 A 1 m	468	1/10/100
---------	----------------------------	-----	----------

### Low voltage sockets / TV socket and RJ11 telephone socket / accessories

#### Sockets

6763 32	TV socket - <b>1 module</b>	204	<b>20/200</b>
6763 33	RJ 11 telephone <b>1 module</b>	202	<b>20/200</b>
6763 34	Double RJ 11 telephone socket <b>1 module</b>	332	<b>20/200</b>
6763 39	RJ 45 socket cat 5e with shutter <b>1 module</b>	544	<b>20/200</b>
6763 40	RJ 45 socket cat 6 with shutter <b>1 module</b>	760	<b>20/200</b>

#### USB chargers (IS13252(Part 1) / IEC 60950-1)

6763 43	USB charger <b>1 module</b>	1058	<b>10/100</b>
<b>6758 21*</b>	USB charger <b>1M 1500MA</b>	1156	<b>10/100</b>
6763 44	Double USB charger <b>2 module</b>	1746	1/10/100

#### Accessories

6763 48	Cable outlet <b>1 module</b>	194	<b>20/200</b>
6763 49	Blanking plate 0.8 mm <b>1 module</b>	54	<b>20/200</b>

### Mylic™ plates

#### Modular Matt Grey plates with frame

6763 50	Matt grey plate 1 m	176	<b>20/200</b>
6763 51	Matt grey plate 2 m	176	<b>20/200</b>
6763 52	Matt grey plate 3 m	246	<b>10/100</b>
6763 53	Matt grey plate 4 m	262	<b>10/100</b>
6763 54	Matt grey plate 6 m	330	<b>5/50</b>
6763 55	Matt grey plate 8 m horizontal	424	<b>5/50</b>
6763 56	Matt grey plate 4x2 m	436	<b>5/25</b>
6763 57	Matt grey 9 m	510	<b>5/50</b>
6763 58	Matt grey plate 12 m	620	<b>10</b>
6763 59	Matt grey plate 18 m	982	<b>10</b>

## Modular colour plates with frame

Cat.Nos	Description	MRP* ₹ / Unit	Pack
---------	-------------	------------------	------

### Pearl white cover plates

6763 60	Pearl white plate 1 m	164	<b>10/100</b>
6763 61	Pearl white plate 2 m	164	<b>10/100</b>
6763 62	Pearl white plate 3 m	218	<b>10/100</b>
6763 63	Pearl white plate 4 m	240	<b>10/100</b>
6763 64	Pearl white plate 6 m	316	<b>5/50</b>
6763 65	Pearl white 8 m plate horizontal	404	<b>5/50</b>
6763 66	Pearl white plate 4x2 m	406	<b>5/25</b>
6763 67	Pearl white plate 9 m	470	<b>5/50</b>
6763 68	Pearl white plate 12 m	576	<b>5/25</b>
6763 69	Pearl white plate 18 m	904	<b>5/25</b>

### Champagne cover plates

6763 70	Champagne plate 1 m	164	<b>10/100</b>
6763 71	Champagne plate 2 m	164	<b>10/100</b>
6763 72	Champagne plate 3 m	218	<b>10/100</b>
6763 73	Champagne plate 4 m	240	<b>10/100</b>
6763 74	Champagne plate 6 m	316	<b>5/50</b>
6763 75	Champagne plate 8 m horizontal	404	<b>5/50</b>
6763 76	Champagne plate 4x2 m	406	<b>5/25</b>
6763 77	Champagne plate 9 m	470	<b>5/50</b>
6763 78	Champagne plate 12 m	576	<b>5/25</b>
6763 79	Champagne plate 18 m	904	<b>5/25</b>

### Silver alu cover plates

6763 80	Silver alu plate 1 m	164	<b>10/100</b>
6763 81	Silver alu plate 2 m	164	<b>10/100</b>
6763 82	Silver alu plate 3 m	218	<b>10/100</b>
6763 83	Silver alu plate 4 m	240	<b>10/100</b>
6763 84	Silver alu plate 6 m	316	<b>5/50</b>
6763 85	Silver alu plate 8 m horizontal	404	<b>5/50</b>
6763 86	Silver alu plate 4x2 m	406	<b>5/25</b>
6763 87	Silver alu plate 9 m	470	<b>5/50</b>
6763 88	Silver alu plate 12 m	576	<b>5/25</b>
6763 89	Silver alu plate 18 m	904	<b>5/25</b>

### Dark bronze cover plates

6763 90	Dark bronze plate 1 m	164	<b>10/100</b>
6763 91	Dark bronze plate 2 m	164	<b>10/100</b>
6763 92	Dark bronze plate 3 m	218	<b>10/100</b>
6763 93	Dark bronze plate 4 m	240	<b>10/100</b>
6763 94	Dark bronze plate 6 m	316	<b>5/50</b>
6763 95	Dark bronze plate 8 m horizontal	404	<b>5/50</b>
6763 96	Dark bronze plate 4x2 m	406	<b>5/25</b>
6763 97	Dark bronze plate 9 m	470	<b>5/50</b>
6763 98	Dark bronze plate 12 m	576	<b>5/25</b>
6763 99	Dark bronze plate 18 m	904	<b>5/25</b>

\* MRP - Maximum Retail Price Inclusive of all taxes including GST.  
\* To be Introduced Shortly

Bold Cat.Nos are products normally available with Legrand (India) Stockists.  
Cat.Nos that are not bold - delivery within 4 - 8 weeks from the date of order.  
Bold packing quantity is our mandatory packing. Orders to be placed by  
Legrand (India) Stockist in multiples of the same.

## Mylic™ boxes

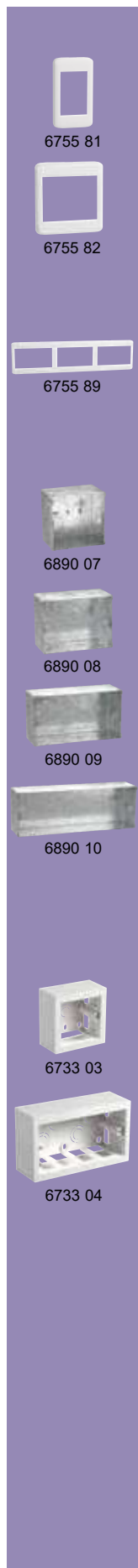

Cat.Nos	Description	MRP* ₹ / Unit	Pack
---------	-------------	---------------------	------

### Modular white surrounds

<b>6755 81</b>	1 module	48	<b>20/200</b>
<b>6755 82</b>	2 modules	72	<b>20/200</b>
<b>6755 83</b>	3 modules	72	<b>10/100</b>
<b>6755 84</b>	4 modules	114	<b>10/100</b>
<b>6755 86</b>	6 modules	166	<b>10/100</b>
<b>6755 89</b>	(2 column x 3) 9 modules (3 column x 3)	286	<b>10/100</b>

### Metal flush boxes

6890 07	Flush box - <b>1/2 modules</b>	138	<b>40</b>
6890 08	Flush box - <b>3 modules</b>	138	<b>40</b>
6890 09	Flush box - <b>4 modules</b>	184	<b>40</b>
6890 10	Flush box - <b>6 modules</b>	288	<b>40</b>
6890 42	Flush box - <b>8 modules</b>	338	<b>40</b>
6890 31	Flush box - <b>4 x 2 modules</b>	336	<b>20</b>
6890 29	Flush box - <b>9 modules</b>	398	<b>20</b>
6890 11	Flush box - <b>12 modules</b>	508	<b>10</b>
6890 13	Flush box - <b>16 modules</b>	582	<b>10</b>
6890 12	Flush box - <b>18 modules</b>	640	<b>10</b>

### Plastic surface boxes

6733 02	Surface box- <b>1/2 modules</b>	88	<b>10/50</b>
6733 03	Surface box- <b>3 modules</b>	102	<b>5/35</b>
6733 04	Surface box- <b>4 modules</b>	118	<b>5/25</b>
6733 06	Surface box- <b>6 modules</b>	154	<b>1/10</b>
6733 08	Surface box- <b>8 modules</b>	230	<b>1/5</b>
6733 05	Surface box- <b>4 x 2 modules</b>	218	<b>1/5</b>
6740 99	Surface box- <b>9 modules</b>	258	<b>1/5</b>

### Metal surface boxes

6890 21	Metal surface box- <b>12 modules</b> (2 rows x 6)	542	<b>1/6</b>
6890 22	Metal surface box- <b>18 modules</b> (3 rows x 6)	568	<b>1/4</b>

# Mylic™

A little touch of genius

A LITTLE TOUCH OF GENIUS



## Guarantee

- The Company, at its discretion, will replace products if they have any manufacturing defect within 10 years for switches (without LED lamp) and power sockets. For all other **Mylic™** wiring accessories the guarantee will be 2 years.
- The above guarantee is applicable when the devices are used in Legrand metal flush boxes. Otherwise the guarantee period will be reduced by 50%.
- The guarantee is only applicable when the products are installed as per the Company's instructions and not tampered in any manner.
- The guarantee states the Company's entire liability. It does not extend to cover consequential loss or damage or installation costs arising from defective products.

\* MRP - Maximum Retail Price Inclusive of all taxes including GST.

# Lyncus<sup>TM</sup>

Change to today

TIME TO CHANGE  
TO TODAY



Today's homes need a range that mirrors their look. A modern sleek look with clean lines. A look that is chic and futuristic. Our new Lyncus range brings the aesthetic to your home, but with a subtle touch that adds character to every room

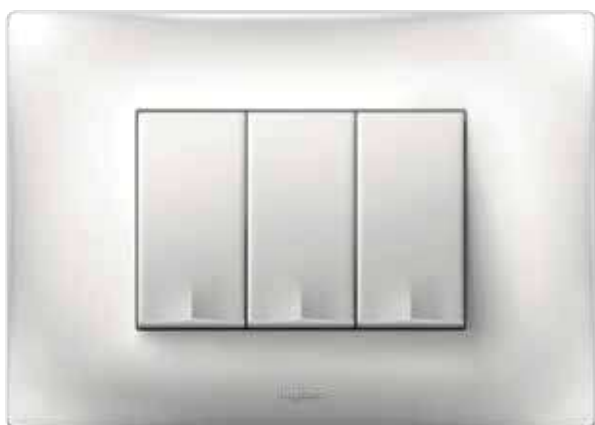

White



Chic Grey



Scan to know more about  
the product.

TIME TO CHANGE  
TO TODAY



## RANGE



Brushed



Alu Sunset



Champagne



Matt Silver

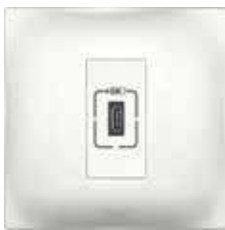

USB TYPE C



USB TYPE A + TYPE C



COMBI TWIN USB



REMOTE CONTROL UNIT



INDUCTION CHARGER



BLUETOOTH SOUND RECEIVER



ONE WAY  
TOUCH SWITCH



TOUCH FAN  
REGULATOR



UNIVERSAL  
TOUCH DIMMER



### mechanisms white

Cat.Nos	Description	MRP* ₹ / Unit	Pack
---------	-------------	------------------	------

#### Switches 6 A 230 V AC

6772 00	6 A Switch 1 W 1 module	86	20/200
6772 01	6 A Switch 2 W 1 module	166	20/200
6772 02	6 A Switch 1 W 1 module with indicator	166	20/200
6772 03	6 A Switch 1 W 1 module with "Light" marking	152	20/200
6772 04	6 A Switch 1 W 1 module with "Fan" marking	152	20/200

#### Switches 10 A 230 V AC

6772 05	10 A Switch 1 W 2 module	202	10/100
6772 06	10 A Switch 2 W 2 module	238	10/100
6772 07	10 A Intermediate switch 2 module	1346	10/100
6772 08	10 A Switch 1 W with indicator 2 module	258	10/100

#### Switches 16 A 230 V AC

6772 09	16 A Switch 1 W 1 module	188	20/200
6772 10	16 A Switch 2 W 1 module	236	20/200
6772 11	16 A Switch 1 W with indicator 1 module	244	20/200

#### Switches 20A 230V AC

6772 12	20 A Switch 1 W 1 module	276	20/200
6772 13	20 A DP Switch 1 W 2 module	406	10/100
6772 14	20 A DP Switch 1 W with indicator 2 module	414	10/100
6772 15	20 A Switch 2 way 2 module	464	10/100

#### Switches 25 A 230 V AC

6772 16	25 A SP 1 W Switch with indicator 1 module	288	20/200
---------	--	-----	--------

#### Switches 32 A 230 V AC

6772 17	32 A DP Switch with indicator 2 module	560	10/100
---------	--	-----	--------

#### Push button 6 A 230 V AC

6772 18	6 A Push button SP 1 module	134	20/200
6772 19	6 A Push button SP with indicator 1 module	194	20/200
6772 20	6 A Bell push 1 module	176	20/200
6772 21	6 A Bell push with indicator 1 module	208	20/200
6772 22	6 A Bell push 2 module	236	10/100
6772 23	6 A Bell push with indicator 2 module	348	10/100

#### Accessories for switches

6772 24	LED Indicator for switches	40	5/50
---------	----------------------------	----	------

#### Socket 240 V AC

6772 25	6/16 A 2 Pin Euro US socket 1 module	302	20/200
6772 26	16 A 3 Pin Switched socket 3 module	594	5/50
6772 27	Multistandard socket 6/10/13 A 2/3 Pin for 250 VAC 15 A for 127 V type 2 Pin 2 module	316	10/100
6772 28	6 A 2/3 Pin Universal socket 2 module	244	20/200
6772 29	6/16 A Socket 3 module	374	5/50
6772 30	6/16 A Socket 2 module	316	10/100
6772 31	6/16 A Euro Socket 2 module	328	10/100
6772 32	25 A Socket 2 module	316	10/100
6772 35	6A 3 Pin ISI Socket - 2 module	158	1/20/200

### mechanisms white

Cat.Nos	Description	MRP* ₹ / Unit	Pack
---------	-------------	------------------	------

#### Dimmers and fan regulators

6772 36	Rotary light dimmer 400 W 1 module	562	5/50
6772 37	Rotary light dimmer 500 W 2 module	718	10/100
6772 39	Fan regulator 100 W 1 module	514	5/50
6772 40	Fan regulator 100 W 360 degree 2 module	636	10/100
6772 41	Fan regulator 120 W 360 degree 2 module	728	10/100
6772 42	Fan step regulator 70 W 2 module	696	1/10/100
6772 44	Fan Regulator 8 step 100 W 2 module	572	1/10/100

#### Emergency light

6772 43	Removable LED lamp 2 module	2310	1/12
---------	-----------------------------	------	------

#### Skirting light

6772 48	LED skirting light 3 module	482	10/100
---------	-----------------------------	-----	--------

#### Indicator

6772 87	Indicator unit 1 module with transparent led & colored labels	510	10/100
---------	---	-----	--------

#### Bell call indicator

6772 49	Bell call indicator 240 V 1 module	956	20/200
---------	------------------------------------	-----	--------

#### Buzzer

6772 50	Buzzer 230 V 1 module	642	20/200
---------	-----------------------	-----	--------

#### Infrared Sensors

6772 51	Infrared sensor 400 W 2 module	1528	1/50
---------	--------------------------------	------	------

#### Remote unit

6772 52	Remote control unit for light & fan 4 module	3710	1/5/20
6773 03	Remote control hand unit	612	1/5/30

#### Hospitality function

##### Hotel keycard switch

6772 53	16 A Key card switch 2 module	3094	1/10
6772 55	Credit card size key fob	104	10/100

##### Hotel "DND and MMR" functions

6772 56	DND & MMR indicator with bell push 1+1 module	340	10/100
6772 57	Internal control unit for DND & MMR 1+1 module	276	10/100

#### Shaver socket

6772 58	Shaver socket 120/240 V MonoBlock with plate 2 module	2378	1/16
---------	---	------	------

#### Sockets and connectors

##### TV sockets

6772 60	TV Coaxial socket 1 module	176	20/200
---------	----------------------------	-----	--------

##### Data & voice

6772 62	Telephone socket RJ11 1 module	164	20/200
---------	--------------------------------	-----	--------

\* MRP - Maximum Retail Price Inclusive of all taxes including GST.  
Red Cat.Nos - new products

Bold Cat.Nos are products normally available with Legrand (India) Stockists. Cat.Nos that are not bold - delivery within 4 - 8 weeks from the date of order. Bold packing quantity is our mandatory packing. Orders to be placed by Legrand (India) Stockist in multiples of the same.

## Lyncus™ sockets and connectors

Cat.Nos	Description	MRP* ₹ / Unit	Pack
---------	-------------	------------------	------

### Data & voice

6772 63	Telephone socket double RJ11 1 module	270	20/200
6772 64	RJ 45 UTP cat 5 tooless with shutter 1 M white	476	20/200
6772 65	RJ 45 UTP cat 6 tooless with shutter 1 M white	668	20/200

### Audio video connectors

6772 67	Preterminated audio video connector 1 module	1286	1/10
6772 68	Preterminated HDMI socket 1 module	1580	1/10
6772 69	Preterminated projector connector 1 module	1580	1/10

### Sound (Volume controller)

6772 70	Volume controller 2 module	1016	1/10/100
---------	----------------------------	------	----------

### Protectors and accessories

#### Motor starter

6772 71	16 A Motor starter 2 module	610	1/10/100
6772 72	25 A Motor starter 2 module	610	1/10/100

#### VSP

6772 74	Voltage surge protector 230 V 1 module	1928	20/200
---------	--	------	--------

### Modular MCB (IS : 608981:2002)

6772 81	16 A MCB SP 1 M C curve	404	1/10/100
6772 82	20 A MCB SP 1 M C curve	404	1/10/100
6772 83	32 A MCB SP 1 M C curve	404	1/10/100

### Electronic function

#### USB chargers (IS13252 (Part 1) / IEC 60950-1)

6772 91*	USB Charger 1500 mA 1 module type A	1010	1/5/50
6772 89	Double USB charger 3000 mA 2 module type A & type C	2340	1/10/100
6772 90	USB Charger 1500 mA 1 module type C	1124	1/5/50

### Combi (Socket + USB)

6772 92	Combi twin USB 2400 mA multistandard socket type A	2698	1/5/50
6772 94	Combi twin USB 2400 mA multistandard socket type A & type C	2970	1/5/50
6772 33	Combi Twin USB 3.1A Euro Socket type A-2 module	1766	1/10/100
6772 34	Combi Twin USB 3.1A Euro Socket type A & Type C - 2 Module	2352	1/10/100

### Wireless charger\*\*

6772 95	Wireless charger + type-A USB 1 A - 5 V / 5 W charger with one 2.4 A/12 W USB port to power a second device	6410	1/10
---------	---	------	------

### Loud speakers

6772 98	Loudspeaker for false ceiling & plaster board 8 Ohms 10 W	2038	1/6
---------	---	------	-----

### Sound diffusion

6772 99*	Bluetooth sound diffusion 2 module	4494	1/10/100
----------	------------------------------------	------	----------

\* MRP - Maximum Retail Price Inclusive of all taxes including GST.

\*\* To be Introduced Shortly

\*\* Charging only with wireless compatible phone having induction receiver technology

Red Cat.Nos - new products

## Lyncus™ electronic function

Cat.Nos	Description	MRP* ₹ / Unit	Pack
---------	-------------	------------------	------

### Rotary dimmer universal

6773 04	Rotary led light dimmer 50 W 1 module	2078	1/10/120
---------	---------------------------------------	------	----------

### Touch switches

6773 09	6 A Touch switch 1 W 2 module	3098	1/50
6773 10	6 A Touch Switch 2 W 2 Module	3580	1/50
6773 13	16 A Touch switch 1 W 2 module	3580	1/50
6773 06	6 A Touch bell push 2 module	3098	1/50

### Touch regulator & dimmer

6773 05	Touch fan regulator 100 W 2 module	3580	1/50
6773 15	300 W Universal led touch light scroll dimming 2 module	3580	1/50

### Reading light

6773 16	Reading light led	1796	1/12
---------	-------------------	------	------

### Accessories

6772 75	Cable outlet 8 mm 1 module	154	20/200
6772 76	Blanking plate 1 module	40	40/400
6772 77	Blanking plate 2 module	54	10/100

## Lyncus™ mechanisms chic grey

### Switches 6A 230V AC

6774 00	6 A Switch 1 W 1 module	104	20/200
6774 01	6 A Switch 2 W 1 module	190	20/200
6774 02	6 A Switch 1 W 1 module with Indicator	194	20/200
6774 03	6 A Switch 1 W 1 module with "Light" marking	186	20/200
6774 04	6 A Switch 1 W 1 module with "Fan" marking	186	20/200

### Switches 10A 230V AC

6774 05	10 A Switch 1 W 2 module	236	10/100
6774 06	10 A Switch 2 W 2 module	268	10/100
6774 07	10 A Intermediate switch 2 module	1548	10/100
6774 08	10 A Switch 1 W with Indicator 2 module	298	10/100

### Switches 16A 230V AC

6774 09	16 A Switch 1 W 1 module	210	20/200
6774 10	16 A Switch 2 W 1 module	266	20/200
6774 11	16 A Switch 1 W with indicator 1 module	276	20/200

### Switches 20A 230V AC

6774 12	20 A Switch 1 W 1 module	326	20/200
6774 13	20 A DP Switch 1 W 2 module	468	10/100
6774 14	20 A DP Switch 1 W with indicator 2 module	476	10/100
6774 15	20 A Switch 2 W 2 module	536	10/100

### Switches 25A 230V AC

6774 16	25A SP 1 W Switch with indicator 1 module	334	20/200
---------	---	-----	--------

Bold Cat.Nos are products normally available with Legrand (India) Stockists. Cat.Nos that are not bold - delivery within 4 - 8 weeks from the date of order. Bold packing quantity is our mandatory packing. Orders to be placed by Legrand (India) Stockist in multiples of the same.

## Lyncus™ mechanisms chic grey

Cat.Nos	Description	MRP* ₹ / Unit	Pack
---------	-------------	------------------	------

### Switches 32A 230V AC

6774 17	32A DP Switch with indicator 2 module	638	10/100
---------	---------------------------------------	-----	--------

### Push button 6 A 230 V AC

6774 18	6 A Push button SP 1 module	154	20/200
6774 19	6 A Push button SP with indicator 1 module	222	20/200
6774 20	6 A Bell push 1 module	202	20/200
6774 21	6 A Bell push with indicator module	240	20/200
6774 22	6 A Bell push 2 module	266	10/100
6774 23	6 A Bell Push with indicator 2 module	402	10/100

### Sockets 240 V AC

6774 25	6/16 A 2 Pin Euro US socket 1 module	352	20/200
6774 27	Multistandard socket 6/10/13 A 2/3 Pin for 250 VAC 15 A for 127 V type 2 Pin 2 module	362	10/100
6774 28	6 A 2/3 Pin Universal socket 2 module	274	20/200
6774 29	6/16 A Socket 3 module	432	5/50
6774 30	6/16 A Socket 2 module	364	10/100
6774 31	6/16 A Euro socket 2 module	376	10/100
6774 32	25 A socket 2 module	364	10/100
6774 35	6A 3 Pin ISI Socket 2 module	184	1/20/200

### Dimmers and fan regulators

6774 36	Rotary light dimmer 400 W 1 module	644	5/50
6774 37	Rotary light dimmer 500 W 2 module	830	10/100
6774 39	Fan regulator 100 W 1 module	598	5/50
6774 40	Fan regulator 100 W 360 degree 2 module	732	10/100
6774 41	Fan regulator 120 W 360 degree 2 module	834	10/100
6774 42	Fan step regulator 70 W 2 module	804	1/10/100
6774 44	Fan regulator 100 W 8 step 2 module	656	1/10/100

### Skirting light

6774 48	LED skirting light 3 module	546	10/100
---------	-----------------------------	-----	--------

### Bell call indicator

6774 49	Bell call indicator 240 V 1 module	1074	20/200
---------	------------------------------------	------	--------

### Buzzer

6774 50	Buzzer 230 V 1 module	724	20/200
---------	-----------------------	-----	--------

### Remote unit

6774 52	Remote control unit for light & fan 4 module	3982	1/5/20
6773 03	Remote control hand unit	612	1/5/30

### Hospitality function

#### Hotel keycard switch

6774 53	16A Key card switch 2 module credit card size key fob	3498	1/10
---------	---	------	------

\* MRP - Maximum Retail Price Inclusive of all taxes including GST.  
 \* To be Introduced Shortly  
 Red Cat.Nos - new products

## Lyncus™ hospitality function

Cat.Nos	Description	MRP* ₹ / Unit	Pack
---------	-------------	------------------	------

### Hotel "DND and MMR" functions

6774 56	DND & MMR indicator with bell push 1+1 module	394	10/100
6774 57	Internal control unit for DND & MMR 1+1 module	316	10/100

### Shaver socket

6774 58	Shaver socket 120/240 V MonoBlock with plate 2 module	2658	1/16
---------	---	------	------

### Sockets and connectors

#### TV sockets

6774 60	TV Coaxial socket 1 module	196	20/200
---------	----------------------------	-----	--------

#### Data & voice

6774 62	Telephone socket RJ11 1 module	186	20/200
6774 63	Telephone socket double RJ11 1 module	318	20/200
6774 64	RJ 45 UTP cat 5 tooless with shutter 1 M grey	524	20/200
6774 65	RJ 45 UTP cat 6 tooless with shutter 1 M grey	732	20/200

#### Audio video sockets

6774 67	Preterminated audio video connector 1 module	1486	1/10
6774 68	Preterminated HDMI socket 1 module	1814	1/10
6774 69	Preterminated projector connector 1 module	1814	1/10

#### Sound (Volume controller)

6774 70	Volume controller 2 module	1170	1/10/100
---------	----------------------------	------	----------

### Electronic function

#### USB chargers (IS13252 (Part 1) / IEC 609501)

6774 91	USB charger 1500 mA 1 module type A	1148	1/5/50
6774 89*	Double USB charger 3000 mA 2 module type A & type C	2688	1/10/100
6774 90	USB charger 1500 mA 1 module type C	1294	1/5/50

#### Combi (Socket+USB)

6774 92	Combi twin USB 2400 mA multi-standard socket type A	3102	1/5/50
6774 94	Combi twin USB 2400 mA multistandard socket type A & type C	3418	1/5/50
6774 33	Combi Twin USB 3.1A Euro Socket type A - 2 module	2030	1/10/100
6774 34	Combi Twin USB 3.1A Euro Socket type A & type C-2 module	2706	1/10/100

#### Sound receiver

6774 99*	Bluetooth sound diffusion 2 module	5168	1/10/100
----------	------------------------------------	------	----------

#### Rotary dimmer universal

6774 24	Rotary led dimmer 50 W 1 module	2632	1/120
---------	---------------------------------	------	-------

#### Accessories

6774 75	Cable outlet 8 mm 1 module	182	20/200
---------	----------------------------	-----	--------

Bold Cat.Nos are products normally available with Legrand (India) Stockists. Cat.Nos that are not bold - delivery within 4 - 8 weeks from the date of order. Bold packing quantity is our mandatory packing. Orders to be placed by Legrand (India) Stockist in multiples of the same.

## Lyncus™ plate frame

Cat.Nos	Description	MRP* ₹ / Unit	Pack
6774 76	Blanking plate 1 module	42	40/400

### Lyncus plate frame white

6775 01	Classic white plate + Frame 1 M	126	20/200
6775 02	Classic white plate + Frame 2 M	126	20/200
6775 03	Classic white plate + Frame 3 M	162	10/100
6775 04	Classic white plate + Frame 4 M	182	10/100
6775 06	Classic white plate + Frame 6 M	226	5/50
6775 08	Classic white plate + Frame 8 M (H)	290	5/50
6775 09	Classic white plate + Frame 2 x 4 M	306	5/25
6775 10	Classic white plate + Frame 9 M	324	5/50
6775 12	Classic white plate + Frame 12 M	422	10
6775 16	Classic white plate + Frame 16 M	490	10
6775 18	Classic white plate + Frame 18 M	664	10

### Plate frame chic grey

6775 21	Chic grey plate+Frame 1 M	160	20/200
6775 22	Chic grey plate+Frame 2 M	160	20/200
6775 23	Chic grey plate+Frame 3 M	222	10/100
6775 24	Chic grey plate+Frame 4 M	232	10/100
6775 26	Chic grey plate+Frame 6 M	290	5/50
6775 28	Chic grey plate + Frame 8 M (H)	392	5/50
6775 29	Chic grey plate + Frame 2x4 M	392	5/25
6775 30	Chic Grey plate + Frame 9 M	424	5/50
6775 32	Chic grey plate + Frame 12 M	550	10
6775 36	Chic grey plate + Frame 16 M	630	10
6775 38	Chic grey plate + Frame 18 M	864	10

### Plate frame brushed

6775 41	Brushed silver plate + Frame 1 M	166	20/200
6775 42	Brushed silver plate + Frame 2 M	166	20/200
6775 43	Brushed silver plate + Frame 3 M	232	10/100
6775 44	Brushed silver plate + Frame 4 M	240	10/100
6775 46	Brushed silver plate + Frame 6 M	310	5/50
6775 48	Brushed silver plate + Frame 8 M (H)	404	5/50
6775 49	Brushed silver plate + Frame 2x4 M	404	5/25
6775 50	Brushed silver plate + Frame 9M (H)	438	5/50
6775 52	Brushed silver plate + Frame 12 M	580	10
6775 56	Brushed silver plate + Frame 16 M	668	10
6775 58	Brushed silver plate + Frame 18 M	904	10

### Plate frame alu sun set

6775 61	Alu sun set plate + Frame 1 M	162	20/200
6775 62	Alu sun set plate + Frame 2 M	162	20/200
6775 63	Alu sun set plate + Frame 3 M	222	10/100
6775 64	Alu sun set plate + Frame 4 M	238	10/100
6775 66	Alu sun set plate + Frame 6 M	306	5/50
6775 68	Alu sun set plate + Frame 8 M	392	5/50
6775 69	Alu sun set plate + Frame 2x4 M	394	5/25

## Lyncus™

Cat.Nos	Description	MRP* ₹ / Unit	Pack
---------	-------------	------------------	------

### Plate frame alu sun set

6775 70	Alu sun set plate + Frame 9 M	424	5/50
6775 72	Alu sun set plate + Frame 12 M	560	10
6775 76	Alu sun set plate + Frame 16 M	642	10
6775 78	Alu sun set plate + Frame 18 M	888	10

### Plate frame champagne

6775 81	Champagne plate + Frame 1 M	162	20/200
6775 82	Champagne plate + Frame 2 M	162	20/200
6775 83	Champagne plate + Frame 3 M	222	10/100
6775 84	Champagne plate + Frame 4 M	238	10/100
6775 86	Champagne plate + Frame 6 M	306	5/50
6775 88	Champagne plate + Frame 8 M (H)	392	5/50
6775 89	Champagne plate + Frame 2x4 M	394	5/25
6775 90	Champagne plate + Frame 9 M	424	5/50
6775 92	Champagne plate + Frame 12 M	560	10
6775 96	Champagne plate + Frame 16 M	642	10
6775 98	Champagne plate + Frame 18 M	888	10

### Plate frame matt silver

6776 01	Matt silver plate + Frame 1 M	162	20/200
6776 02	Matt silver plate + Frame 2 M	162	20/200
6776 03	Matt silver plate + Frame 3 M	222	10/100
6776 04	Matt silver plate + Frame 4 M	238	10/100
6776 06	Matt silver plate + Frame 6 M	306	5/50
6776 08	Matt silver plate + Frame 8 M (H)	392	5/50
6776 09	Matt silver plate + Frame 2x4 M	394	5/25
6776 10	Matt silver plate + Frame 9 M	424	5/50
6776 12	Matt silver plate + Frame 12 M	560	10
6776 16	Matt silver plate + Frame 16 M	642	10
6776 18	Matt silver plate + Frame 18 M	888	10

## Mounting boxes

### Metal flush boxes

6890 07	Flush box - 1/2 module	138	40
6890 08	Flush box - 3 module	138	40
6890 09	Flush box - 4 module	184	40
6890 10	Flush box - 6 module	288	40
6890 42	Flush box - 8 module	338	40
6890 31	Flush box - 8 module (2 row x 4)	336	20
6890 29	Flush box - 9 module	398	20
6890 11	Flush box - 12/16 (2 row x 6) module	508	10
6890 12	Flush box - 18 module	640	10

### Plastic surface boxes

6733 02	Surface box 1/2 module	88	10/50
6733 03	Surface box 3 module	102	5/35
6733 04	Surface box 4 module	118	5/25
6733 06	Surface box 6 module	154	1/10
6733 08	Surface box 8 module	230	1/5
6733 05	Surface box 8 (2 row x 4) module	218	1/5

### Metal surface boxes

6890 21	Surface box 12/16 (2 row x 6) module	542	1/6
6890 22	Surface box 18 module	568	1/4

\* MRP - Maximum Retail Price Inclusive of all taxes including GST.  
 \* To be Introduced Shortly  
 Red Cat.Nos - new products

Bold Cat.Nos are products normally available with Legrand (India) Stockists.  
 Cat.Nos that are not bold - delivery within 4 - 8 weeks from the date of order.  
 Bold packing quantity is our mandatory packing. Orders to be placed by Legrand (India) Stockist in multiples of the same.



# Britzy™ SWITCHES

THE  
NO PROBLEM  
SWITCH



ORANGE  
CHROME

HERB  
BEIGE

URBAN  
BRONZE

WARM  
ORANGE  
SILVER

Now Available In  
4 New Colours



Scan to know more about  
the product.



# Britzy™ SWITCHES

## RANGE



Switch 6 A, 16 A



Switch 6 A two-way



Switch with indicator  
6 A, 16 A, 25 A



Bell push with  
indicator - 1 module



DP Switch 20 A, 32 A



Bell push with  
indicator - 2 module



DND internal unit



DND external unit



Universal socket  
6 A - 3 pin



Multi-standard socket



6/16 A socket



Euro US socket



Dimmer



Fan regulator  
1 module



Fan regulator  
2 module



USB charger  
1 module



USB charger  
2 module



RJ 45



RJ 11 Telephone socket



Double RJ 11  
Telephone socket



Bell call indicator



TV socket



Skirting light



Buzzer



Key card Switch 16 A











Flat indicator red

## Britzy™ switches

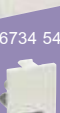

Cat.Nos	Description	MRP* ₹ / Unit	Pack
---------	-------------	------------------	------

### Switches

- All switches are ISI marked as per latest IS 3854:1997
- Finger-proof terminal for protection against accidental contact
- Laser marking for easy identification







 6734 01	6 A Switch SP 1 way <b>1 module</b>	44	20/400
 6734 02	6 A Switch SP 2 way <b>1 module</b>	98	20/200
 6734 03	6 A Switch SP 1 way with indicator <b>1 module</b>	98	20/200
 6734 11	16 A Switch SP 1 way <b>1 module</b>	140	20/200
 6734 12	16 A Switch SP 2 way <b>1 module</b>	170	20/200
 6734 13	16 A Switch SP 1 way with indicator <b>1 module</b>	154	20/200
 6734 24	25 A Switch SP 1 way with indicator <b>1 module</b>	194	20/200
 6734 25	20 A DP switch with indicator <b>2 modules</b>	216	10/100
 6734 26	32 A DP switch with indicator <b>2 modules</b>	288	10/100

### Push buttons



 6734 04	6 A Bell push with indicator <b>module 1</b>	118	20/200
 6734 06	6 A Bell push with indicator <b>2 module</b>	180	10/100

### Sockets

- Confirming to IS 1293:2005
- Shuttered socket for child safety
- Shutter open only with phase and neutral insertion simultaneously

 6734 52	6 A 3 pin universal socket <b>2 modules</b>	120	20/200
 6734 53	Euro US socket <b>1 module</b>	104	20/200
 6734 55	6/16 A socket 3 Pin <b>2 modules</b>	196	10/100
 6734 56	25 A socket 3 Pin <b>2 modules</b>	218	10/100
 6734 54	Multistandard socket <b>2 modules</b>	176	10/100
 6734 27	6A 3-Pin ISI Socket <b>2 module</b>	108	1/20/200

### Data & voice

 6734 41	RJ11 telephone socket <b>1 module</b>	104	20/200
 6734 44	Double RJ11 telephone socket <b>1 module</b>	154	20/200
 6734 45	RJ45 Cat 6 computer socket <b>1 module</b>	306	20/200

- \* MRP - Maximum Retail Price Inclusive of all taxes including GST.
- To be Introduced Shortly

## Britzy™ switches

Cat.Nos	Description	MRP* ₹ / Unit	Pack
---------	-------------	------------------	------



### Television socket

 6734 46	TV socket <b>1 module</b>	98	20/200
---	---------------------------	----	--------

### Buzzer

 6734 40	Buzzer 230 V <b>1 module</b>	316	20/200
---	---------------------------------	-----	--------

### Dimmer & regulator

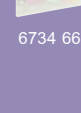
 6734 31	Fan regulator 100 W <b>1 module</b>	420	5/50
 6734 30	Fan regulator 100 W <b>2 modules</b>	536	10/100
 6734 33	Light dimmer 400 W <b>1 module</b>	432	5/50
 6734 38	Fan Regulator 8 Step 100 W <b>2 module</b>	482	1/10/100





### Bell indicator

 6734 07	Bell call indicator 1 module	586	20/200
---	------------------------------	-----	--------



### Motor starter

 6734 66	25 A Motor starter <b>2 modules</b>	498	10/100
--	--	-----	--------

### Modular MCB (IS : 60898-1:2002)

 6734 64	Modular SP MCB 16A	340	1/10/100
 6734 61	Modular SP MCB 20A	340	1/10/100
 6734 36	Modular SP MCB 25A	340	1/10/100
 6734 37	Modular SP MCB 32A	340	1/10/100

### USB Charger

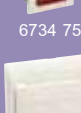
 6734 34	USB charger <b>1M 1000mA</b>	686	10/100
 6731 35*	USB charger <b>1M 1500mA</b>	808	10/100
 6734 35	Double USB charger 2M 2000mA	1154	5/50



### Skirting light

 6734 77	Skirting light <b>2 modules</b>	418	5/50
---	---------------------------------	-----	------

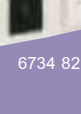

### Indicator

 6734 75	Flat indicator red <b>1 module</b>	104	20/200
---	------------------------------------	-----	--------

### Key card switch

 6734 80	16 A Key card switch 2 modules	2100	1/10
 6734 83	Keyfob credit card size for 6734 80	154	1/10

### Do Not Disturb indicator & internal control unit

 6734 81	DND internal unit <b>2 modules</b>	236	10/100
 6734 82	DND external unit <b>2 modules</b>	278	10/100

### Accessories

6734 71	Cable outlet <b>1 module</b>	84	20/200
6734 90	Blanking plate <b>1 module</b>	26	20/200
6734 72	Blanking plate <b>2 modules</b>	36	10/100

Bold Cat.Nos are products normally available with Legrand (India) Stockists. Cat.Nos that are not bold - delivery within 4 - 8 weeks from the date of order. Bold packing quantity is our mandatory packing. Orders to be placed by Legrand (India) Stockist in multiples of the same.

## Britzy™ switches

Cat.Nos	Description	MRP* ₹ / Unit	Pack
---------	-------------	------------------	------

### White plates with frame

Sleek and curvy plates with elegant looks comes with sturdy support frame for solid strength

6734 91	Plate & frame 86 x 86 <b>1 module</b>	82	20/200
6734 92	Plate & frame 86 x 86 <b>2 modules</b>	82	20/200
<b>6734 93</b>	Plate & frame 121 x 86 <b>3 modules</b>	112	<b>10/100</b>
<b>6734 94</b>	Plate & frame 146 x 86 <b>4 modules</b>	122	<b>10/100</b>
<b>6734 96</b>	Plate & frame 224 x 86 <b>6 modules</b>	156	<b>5/50</b>
<b>6734 98</b>	Plate & frame 245 x 86 <b>8 modules</b>	200	<b>5/50</b>
<b>6734 95</b>	Plate & frame 146 x 172 <b>4 x 2 modules</b>	200	<b>5/25</b>
<b>6734 97</b>	Plate & frame 224 x 172 <b>12 modules</b>	292	10
6734 99	Plate & frame 245 x 172 <b>16 modules</b>	314	10
6735 00	Plate & frame 224 x 240 <b>18 modules</b>	386	10

### WARM ORANGE SILVER plates with frame

6735 01	Plate & frame 86 x 86 <b>1 module</b>	132	20/200
6735 02	Plate & frame 86 x 86 <b>2 modules</b>	132	20/200
6735 03	Plate & frame 121 x 86 <b>3 modules</b>	166	<b>10/100</b>
6735 04	Plate & frame 146 x 86 <b>4 modules</b>	198	<b>10/100</b>
6735 05	Plate & frame 224 x 86 <b>6 modules</b>	276	5/50
6735 06	Plate & frame 245 x 86 <b>8 modules</b>	298	5/50
6735 07	Plate & frame 146 x 172 <b>4 x 2 modules</b>	360	5/25
6735 08	Plate & frame 224 x 172 <b>12 modules</b>	500	10
6735 09	Plate & frame 245 x 172 <b>16 modules</b>	674	10
6735 10	Plate & frame 224 x 240 <b>18 modules</b>	776	10

### HERB BEIGE plates with frame

6735 11	Plate & frame 86 x 86 <b>1 module</b>	132	20/200
6735 12	Plate & frame 86 x 86 <b>2 modules</b>	132	20/200
6735 13	Plate & frame 121 x 86 <b>3 modules</b>	166	<b>10/100</b>
6735 14	Plate & frame 146 x 86 <b>4 modules</b>	198	<b>10/100</b>
6735 15	Plate & frame 224 x 86 <b>6 modules</b>	276	5/50
6735 16	Plate & frame 245 x 86 <b>8 modules</b>	298	5/50

## Britzy™ switches

Cat.Nos	Description	MRP* ₹ / Unit	Pack
---------	-------------	------------------	------

### HERB BEIGE plates with frame

6735 17	Plate & frame 146 x 172 <b>4 x 2 modules</b>	360	5/25
6735 18	Plate & frame 224 x 172 <b>12 modules</b>	500	10
6735 19	Plate & frame 245 x 172 <b>16 modules</b>	674	10
6735 20	Plate & frame 224 x 240 <b>18 modules</b>	776	10

### URBAN BRONZE plates with frame

6735 21	Plate & frame 86 x 86 <b>1 module</b>	132	20/200
6735 22	Plate & frame 86 x 86 <b>2 modules</b>	132	20/200
6735 23	Plate & frame 121 x 86 <b>3 modules</b>	166	<b>10/100</b>
6735 24	Plate & frame 146 x 86 <b>4 modules</b>	198	<b>10/100</b>
6735 25	Plate & frame 224 x 86 <b>6 modules</b>	276	5/50
6735 26	Plate & frame 245 x 86 <b>8 modules</b>	298	5/50
6735 27	Plate & frame 146 x 172 <b>4 x 2 modules</b>	360	5/25
6735 28	Plate & frame 224 x 172 <b>12 modules</b>	500	10
6735 29	Plate & frame 245 x 172 <b>16 modules</b>	674	10
6735 30	Plate & frame 224 x 240 <b>18 modules</b>	776	10

### ORANGE CHROME plates with frame

6735 31#	Plate & frame 86 x 86 <b>1 module</b>	132	20/200
6735 32#	Plate & frame 86 x 86 <b>2 modules</b>	132	20/200
6735 33#	Plate & frame 121 x 86 <b>3 modules</b>	166	<b>10/100</b>
6735 34#	Plate & frame 146 x 86 <b>4 modules</b>	198	<b>10/100</b>
6735 35#	Plate & frame 224 x 86 <b>6 modules</b>	276	5/50
6735 36#	Plate & frame 245 x 86 <b>8 modules</b>	298	<b>5/50</b>
6735 37#	Plate & frame 146 x 172 <b>4 x 2 modules</b>	360	5/25
6735 38#	Plate & frame 224 x 172 <b>12 modules</b>	500	10
6735 39#	Plate & frame 245 x 172 <b>16 modules</b>	674	10
6735 40#	Plate & frame 224 x 240 <b>18 modules</b>	776	10

\* MRP - Maximum Retail Price Inclusive of all taxes including GST.  
# To be Introduced Shortly

Bold Cat.Nos are products normally available with Legrand (India) Stockists. Cat.Nos that are not bold - delivery within 4 - 8 weeks from the date of order. Bold packing quantity is our mandatory packing. Orders to be placed by Legrand (India) Stockist in multiples of the same.

## Britzy™ switches

Cat.Nos	Description	MRP* ₹ / Unit	Pack
---------	-------------	---------------------	------

### Flush mounting boxes - Metal

- Boxes are with top, bottom, side and back wall knockout for conduit entry from any direction
- Possible to break open knockout without any special tool

6890 60	Metal flush box 75.7 x 75.7 x 50.8 <b>1 &amp; 2 modules</b>	70	40
6890 61	Metal flush box 98.9 x 75.7 x 50.8 <b>3 modules</b>	92	40
6890 62	Metal flush box 136 x 75.7 x 50.8 <b>4 modules</b>	114	40
6890 63	Metal flush box 213.4 x 75.7 x 50.8 <b>6 modules</b>	180	40
6890 64	Metal flush box 136.6 x 136.8 x 61 <b>8 (2 rows x 4) modules</b>	226	20
6890 65	Metal flush box 231.2 x 75.7 x 50.8 <b>8 modules</b>	226	40
6890 66	Metal flush box 215 x 145.3 x 61.2 <b>12 (2 rows x 6) modules</b>	314	10
6890 67	Metal flush box 232.8 x 147.4 x 61.2 <b>16 (2 rows x 8) modules</b>	352	10
6890 68	Metal flush box 215 x 213.3 x 61.2 <b>18 modules</b>	402	10

### Surface mounting boxes - Plastic

6890 70	Plastic surface box 86 x 86 x 45 <b>1 &amp; 2 modules</b>	60	10/50
6890 71	Plastic surface box 121 x 86 x 45 <b>3 modules</b>	78	5/35
6890 72	Plastic surface box 146 x 86 x 45 <b>4 modules</b>	102	5/25
6890 73	Plastic surface box 224 x 86 x 45 <b>6 modules</b>	148	1/10
6890 74	Plastic surface box 146 x 172 x 45 <b>8 (2 rows x 4) modules</b>	208	2/10
6890 75	Plastic surface box 245.2 x 86 x 45 <b>8 modules</b>	208	1/10
6890 76	Plastic surface box 224 x 172 x 45 <b>12 (2 rows x 6) modules</b>	252	1/10
6890 77	Plastic surface box 245.2 x 172 x 45 <b>16 (2 rows x 8) modules</b>	296	1/10

### Surface mounting boxes - Metal

6890 78	Metal surface box <b>18 modules</b>	312	1/10
---------	--	-----	------

- \* MRP - Maximum Retail Price Inclusive of all taxes including GST.
- To be Introduced Shortly

# Britzy™ SWITCHES

## THE NO PROBLEM SWITCH



### Guarantee

- The Company, at its discretion, will replace products if they have any manufacturing defect within 10 years for switches (without LED lamp) and power sockets. For all other Britzy™ wiring accessories the guarantee will be 2 years.
- The above guarantee is applicable when the devices are used in Legrand metal flush boxes. Otherwise the guarantee period will be reduced by 50%.
- The guarantee is only applicable when the products are installed as per the Company's instructions and not tampered in any manner.
- The guarantee states the Company's entire liability. It does not extend to cover consequential loss or damage or installation costs arising from defective products.



# UX FOR UPSCALE HOTELS

## FIVE STAR SOLUTION

Designed specifically for premium level establishments, UX for Upscale Hotels provides top quality solutions with its brand-new touchplates and enhanced functionalities. Operating on an open protocol, the guest room management system can seamlessly integrate with third party building management systems, thus raising hospitality to new heights across the world. In conjunction with Arteor or other Legrand wiring device ranges.

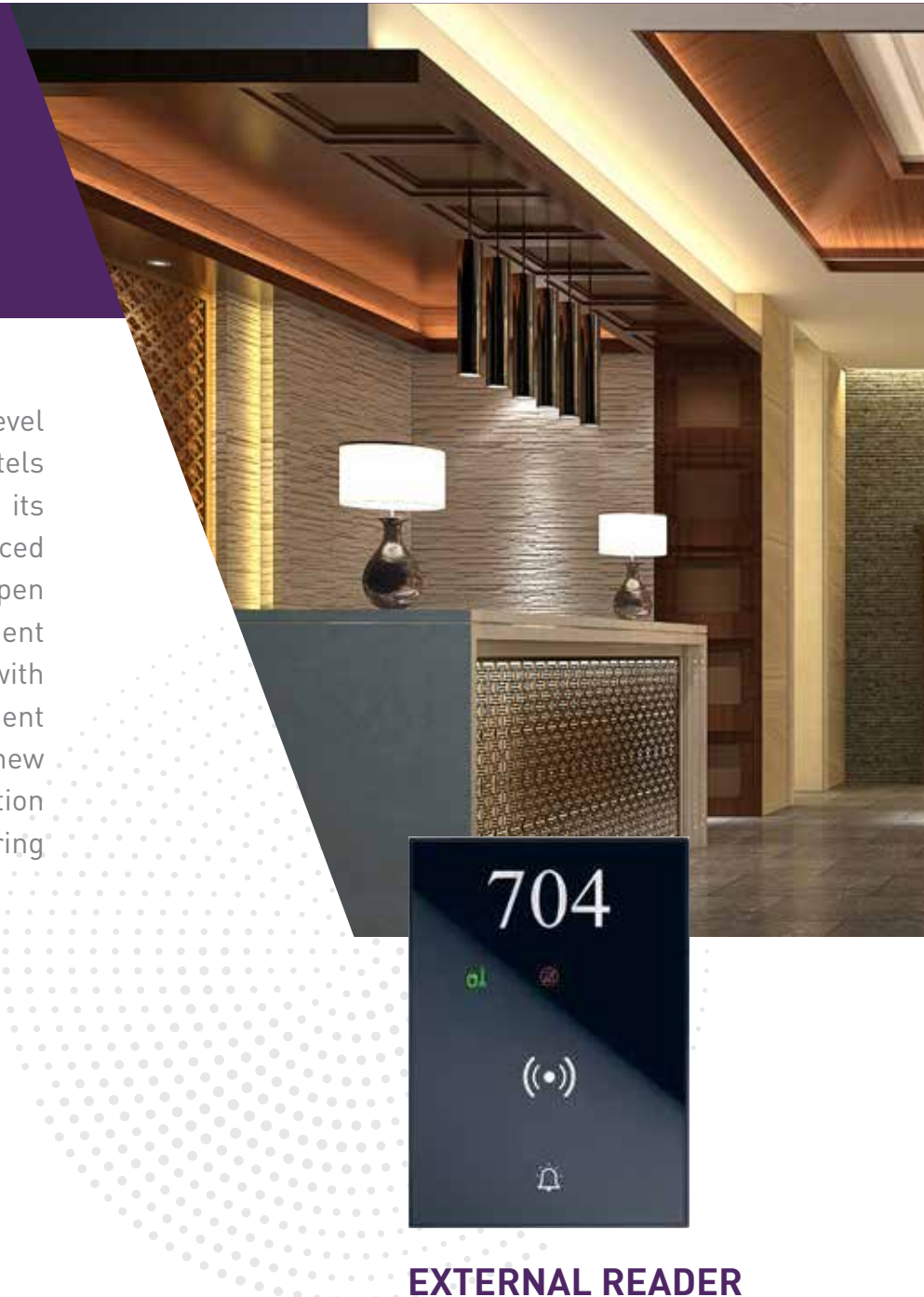

**EXTERNAL READER**



Scan to know more about  
the product.

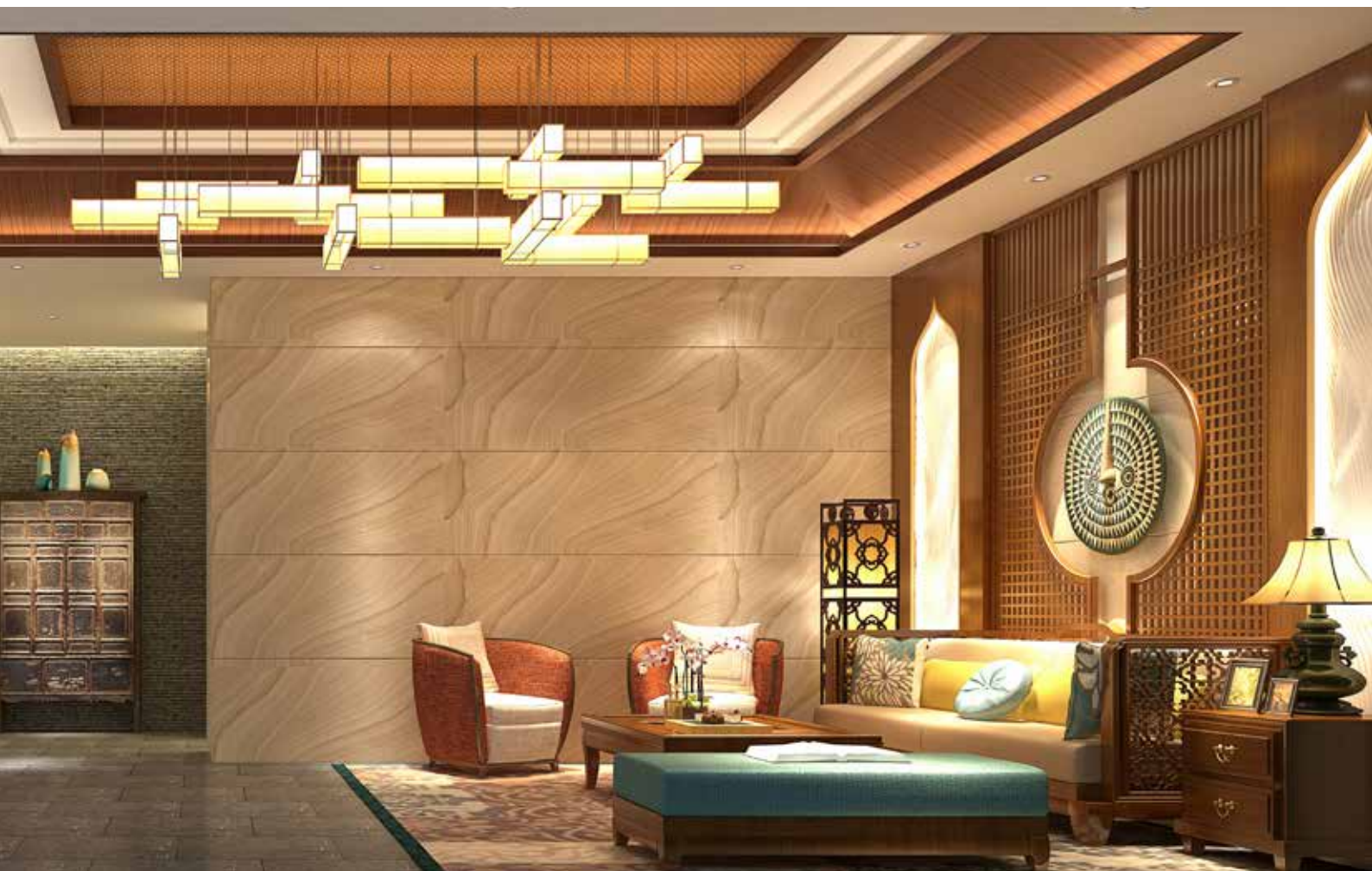

**KEY CARD READER**



**6-GANG TOUCH PLATE**



**BEDSIDE PANEL**

# WORKSTATION SOLUTIONS

## POWER AND DATA DISTRIBUTION FOR THE OFFICE ENVIRONMENT

In order to guarantee convenience and performance for users in office buildings, workstations & different areas must be fitted with solutions that can be fully adjusted to different building infrastructures and still meet the user's connectivity and mobility needs.

These ranges of products are solutions for supplying and fitting out workstations in any kind of building infrastructure: Raised Floor, Flush Floor, Screed Floor & False Ceiling & Wall.



Pop-up boxes - for floor



Snap-On mini-columns

### LEGRAND'S SOLUTION FOR DISTRIBUTING POWER AND DATA TO WORKSTATIONS

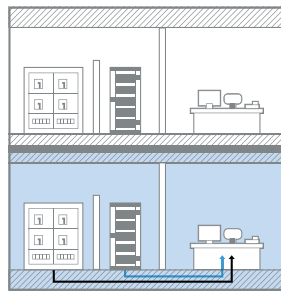

Work station solution supplied through the floor

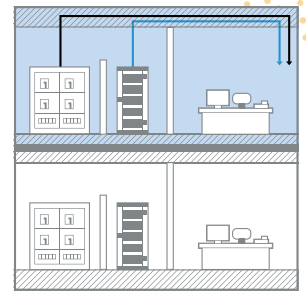

Work station solution supplied through the false ceiling & the wall



Scan to know more about the product.



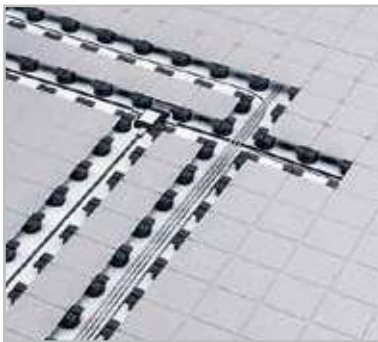

**Soluflex cable floor system**

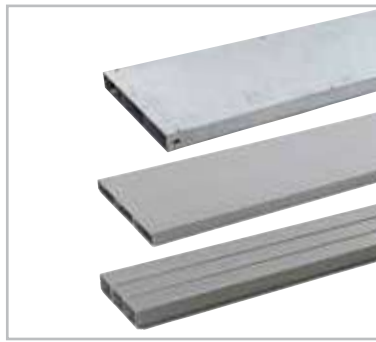

**Raceways : PVC & Metal (GI)**



**Floor boxes**



**Pop- up Box**



**Power & data desk grommets**



**Dlp trunking system:  
Snap-on, Mini & PVC, Aluminium**

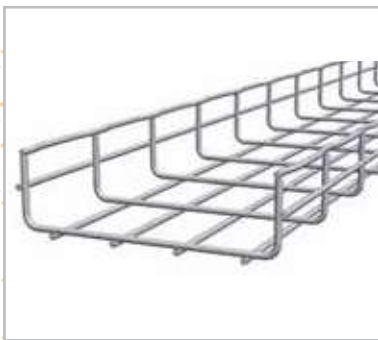

**Cablofil wire mesh cable trays**



**Cable worm**



**Flush mounting power & data module**

**POWER AND DATA DISTRIBUTION & CONNECTION SOLUTIONS**

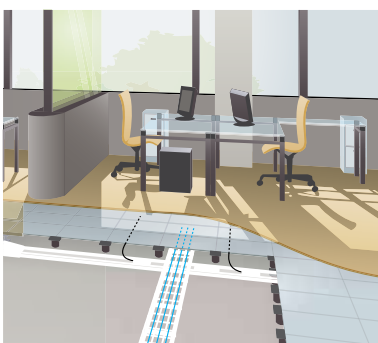

**Raised access floor systems**



**Screed floor system**

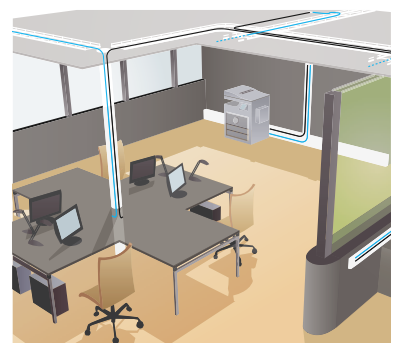

**Wall and ceiling systems**



# CABLOFIL®

## CABLOFIL IS THE MOST VERSATILE CABLE TRAY

Since its introduction 40 years ago, CABLOFIL has revolutionized Electrical and Telecommunication Cable support systems. CABLOFIL is one of the safest and most economical cable support systems available.

Made from welded steel wires, CABLOFIL meets the strictest of safety standards and satisfies the customer's need for reliability and fast economical installation.

### Cablofil is a Full cable Management Solution

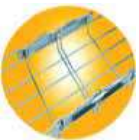

**FAST -**  
Fast Coupling Solution Without Nuts And Bolts  
Time Saving For More Economy



**EASY-**  
Fixing Without Hardware On Profiles And Brackets  
Secure By Bending The Fastening Tab  
No More Nuts And Bolts



**SECURE**  
For Cables  
For Installers  
For Installations  
Natural Ventilation Of Cables  
Cleanliness With No Retention Of Dust



**AVAILABLE**  
2000 Items In Stock  
8 Regional Hubs Worldwide  
More Than 2000 Distributors  
And our service with the same Quantity  
For Products Are Available In More Than 60 Countries Around The World

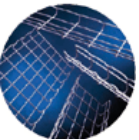

**COMPLETE RANGE**  
For Every Environments  
For Any Type Of Installations  
For Any Type Of Activities



**QUALITY**  
The most tested and Certified Cable Tray  
The Most Specified Cable Tray In The World  
40 Years Of Sales & Technical Assistance



**ECONOMICAL**  
Cable Management Made On-Site  
Time Saving, Forget About Specifics Development!  
No More Specific Products For Derivations  
No More Missing Products On-Site



**PERFORMANCE**  
Maximum Strenth  
Gauranteed Span Of 2 Meters  
Between Supports  
In Conformity With European And International Standards Cei/61537 & Vde/639



Scan to know more about the product.



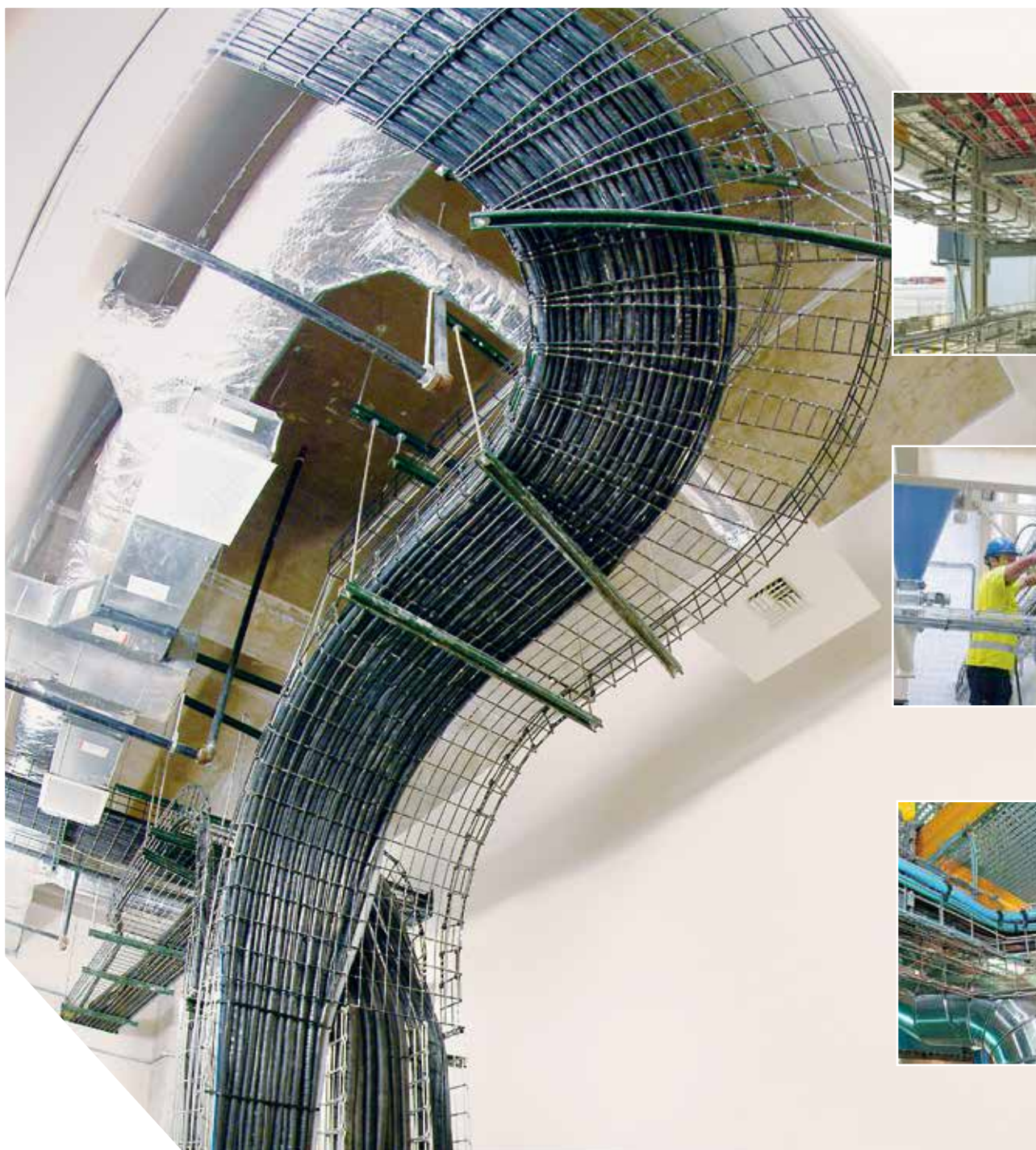

## Raceways and junction boxes for screed floors

Cat.Nos	Description	MRP* ₹ / Unit	Pack
---------	-------------	------------------	------

Confirms to EN 50 085 - 2 - 2  
Raceways are made from PVC and Galvanised sheet.  
Compatible with Cat.6 structured cabling system.

### Raceways - PVC

**Raceways - PVC - height 38 mm;  
Standard length 2 meters<sup>(1)</sup>; Price per meter**

0896 67	50 mm x 38 mm - 1 compartment	1250	12
0896 68	100 mm x 38 mm - 2 compartments	2346	16
0896 69	150 mm x 38 mm - 3 compartments	3520	10

### Raceways - Metal / GI

**Raceways - Metal/GI - height 25 mm; length 2.44 m.  
Price per unit (One unit is of 2.44 meters)**

6895 10	50 mm x 25 mm - 1 compartment	2182	3/54 <sup>(1)</sup>
6895 11	75 mm x 25 mm - 1 compartment	2812	3/21 <sup>(1)</sup>
6895 12	100 mm x 25 mm - 1 compartment	3416	3/54 <sup>(1)</sup>
6895 13	150 mm x 25 mm - 1 compartment	4726	3/18 <sup>(1)</sup>
6895 14	225 mm x 25 mm - 3 compartments	7412	3/12 <sup>(1)</sup>
6895 15	300 mm x 25 mm - 3 compartments	9176	3/18 <sup>(1)</sup>

**Raceways - Metal/GI - height 38 mm; length 2.44 m  
Price per unit (One unit is of 2.44 meters)**

6895 00	50 mm x 38 mm - 1 compartment	2536	3/54 <sup>(1)</sup>
6895 01	75 mm x 38 mm - 1 compartment	3348	3/21 <sup>(1)</sup>
6895 02	100 mm x 38 mm - 1 compartment	4052	3/54 <sup>(1)</sup>
6895 03	150 mm x 38 mm - 1 compartment	5434	3/36 <sup>(1)</sup>
6895 04	225 mm x 38 mm - 3 compartments	8228	3/12 <sup>(1)</sup>
6895 05	300 mm x 38 mm - 3 compartments	10076	3/18 <sup>(1)</sup>

### Raceways accessories

#### Fixing bracket (GI)

**For fixing raceways (PVC & Metal) on the floor**

6897 09	50 mm x 25 mm (metal)	34	9
6897 10	75 mm x 25 mm (PVC and metal)	58	9
6897 12	100 mm x 25 mm (metal)	66	9
6897 15	150 mm x 25 mm (metal)	84	9
6897 20	225 mm x 25 mm (metal)	118	9
6897 30	300 mm x 25 mm (metal)	156	9

#### Fixing bracket

6897 27	50 mm x 38 mm (PVC and metal)	38	9
6897 28	75 mm x 38 mm (metal)	66	9
6897 37	100 mm x 38 mm (PVC and metal)	78	9
6897 38	150 mm x 38 mm (PVC and metal)	96	9
6897 25	225 mm x 38 mm (metal)	150	9
6897 35	300 mm x 38 mm (metal)	188	9

### Riser

6897 23	Vertical - for 225 mm width raceways	2634	1
6897 33	Vertical - for 300 mm width raceways	3030	1

\* MRP - Maximum Retail Price Inclusive of all taxes including GST.  
(1) Unit of measure in Nos  
<sup>1</sup>To be ordered in multiples of 2 meters

## Raceways and junction boxes for screed floors

Cat.Nos	Description	MRP* ₹ / Unit	Pack
---------	-------------	------------------	------

### Coupler for joining raceways

6897 77	Coupling 38	154	6
6897 79	Coupling 25	116	6

### Junction box

For direct access to cables at the intersection of raceways  
Supplied completely with base and cover plate (Lid)

#### Height adjustable junction box 65 - 90 mm

6896 10	150 x 150 x 65 - 90 mm	2922	1
6896 11	225 x 225 x 65 - 90 mm	3622	1
6896 12	300 x 300 x 65 - 90 mm	4768	1
6896 13	400 x 400 x 65 - 90 mm	7218	1

#### Height adjustable junction box 65 - 90 mm with fly over

For direct access to cables at the intersection of floor raceways while maintaining perfect separation and 900 cross overs between data and power cables

6896 14	225 x 225 x 65 - 90 mm with flyover	4000	1
6896 15	300 x 300 x 65 - 90 mm with flyover	5324	1
6896 16	400 x 400 x 65 - 90 mm with flyover	7988	1

#### Optional site cover for junction box

6896 18	150 x 150 x 65 - 90 mm with metal cover	330	10
6896 19	225 x 225 x 65 - 90 mm with metal cover	468	10
6896 20	300 x 300 x 65 - 90 mm with metal cover	708	10
6896 21	400 x 400 x 65 - 90 mm with metal cover	1076	10

#### Height adjustable junction box 50 - 70 mm

6896 22	150 x 150 x 50-70 mm	2690	1
6896 23	225 x 225 x 50-70 mm	3304	1
6896 24	300 x 300 x 50-70 mm	4396	1
6896 25	400 x 400 x 50-70 mm	6590	1

## Floor boxes for carpet for raised floor, screed floor

### Floor boxes for raised floor

6896 38	Full backbox for raised floor - 3 compartments (264x264 mm) height 86 mm (for ducting upto 225 mm).	4596	1
6896 31	Lid & trim Grey cover RAL 7031 for 3 compartment floor box with flexible cable exits Size 265 mm x 265 mm	3466	5

### Support plates for floor boxes 77 mm width plate

6896 62	Blank plates for floor box	388	12
6896 17	Flat support plate 8 module for integration of Myrius mechanisms	388	1
6896 78	Waved support plates. For 4 modules (2 x 2 modules)	1176	4

Bold Cat.Nos are products normally available with Legrand (India) Stockists. Cat.Nos that are not bold - delivery within 4 - 8 weeks from the date of order. Bold packing quantity is our mandatory packing. Orders to be placed by Legrand (India) Stockist in multiples of the same.



## Floor boxes for carpet for raised floor, screed floor

Cat.Nos	Description	MRP* ₹ / Unit	Pack
---------	-------------	------------------	------

### Floor boxes for screed floor (3 Compartment)

6896 34*	Full backbox for screed floor 3 compartments (for ducting upto 225 mm). Height adjustable to screed height 65 to 90 mm	7116	1
6896 31*	Lid & trim Grey cover RAL 7031 for 3 compartment floor box with flexible cable exits. Size 265 mm x 265 mm	3466	5



6896 34 +  
6896 31

### Support plates for floor boxes 77 mm width plate

6896 62	Blank plates for floor box	388	12
6896 17	Flat support plate 8 module for integration of Myrius mechanisms	388	1
6896 78	Waved support plates for 4 modules (2x2 modules)	1176	4

### Floor boxes for screed floor (4 Compartment)

6896 45	Full backbox for screed floor - 4 compartments (for ducting upto 300 mm) Height adjustable to screed height 65 to 90 mm. To be used with 6896 45	7916	1
6896 41	Lid & trim Grey cover RAL 1019 for 4 compartment floor box with flexible cable exits. To be used with 6896 41	3806	5

### Support plates for floor boxes

77 mm width plate

6896 62	Blank plates for floor box	388	12
6896 17	Flat support plate 8 module for integration of Myrius	388	1
6896 78	Waved support plates For 4 Modules (2x2 Modules) mechanisms	1176	4

### Stainless steel insert for Lid

For a metal finish on lid

To be used instead of fitting carpet onto the Lid

6896 92	For 3 compartment floor boxes dimension : 245.5x210 mm	4280	1
---------	--	------	---

## Floor boxes for tile / marble

### for screed floor

0896 04	Backbox for screed floor; Screed thickness 65 to 90 mm (for ducting upto 225 mm).	6084	1
6896 52	Lid & trim for tiles / marble 15 to 22 mm thickness Stainless steel material AISI 304. 2 cable outlet	29828	1
6896 55	Lid & Trim for tile 8-15 mm thickness Material for head band & single cable outlet - galvanised steel + paint RAL 7031	8178	1

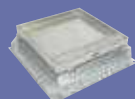

0896 04 +  
6896 52

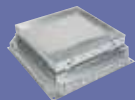

0896 04 +  
6896 55

\* MRP - Maximum Retail Price Inclusive of all taxes including GST.  
# 6896 34 + 6896 31 with support plates and wiring devices

## Floor boxes for tile / marble

Cat.Nos	Description	MRP* ₹ / Unit	Pack
---------	-------------	------------------	------

### for screed floor

6896 56	Lid & Trim for tile 8-15 mm thickness Material for head band & single cable outlet - stainless steel 304	9968	1
---------	--	------	---

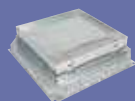

0896 04 +  
6896 56

### Support plates for floor boxes

77 mm width plate

6896 62	Blank plates for floor box	388	12
6896 17	Flat support plate 8 module for integration of Myrius	388	1
6896 78	Waved support plates For 4 Modules (2x2 Modules) mechanisms	1176	4

### 50 mm reduced height floor boxes

0880 73	Back box for Concrete Floor (to be used with 0880 70) (for ducting upto 225x25 mm)	8984	1
0880 70	Lid and Trim for Screed Floor between 50 and 70 mm. With Cover for carpet; grey RAL 7031 Can be equiped with SS finishing plate 0880 72 16 Module	8872	1
0880 72	Stainless steel finishing plate for 50 mm floor box	5524	1

## Heavy duty in-screed floor box

### for screed floors

#### Metal in-screed floor box

0896 34	Universal metal in-screed backbox	24686	1
---------	-----------------------------------	-------	---



0896 34 +  
0896 83 +  
0896 85

#### Accessories for metal in-screed floor box

0896 83	Normal load support upto 8 KN load with deflection <6 mm	25148	1
0896 84	Heavy load support upto 20 KN load with deflection <3 mm	42520	1



0896 34 +  
0896 83 +  
0896 86 +  
0896 87

#### Plates for metal in-screed floor boxes

77 mm width plate

0896 85	IP 66 plain cover (cover closed) access trap for junction. No cable exit	42924	1
---------	--	-------	---

### Heavy duty in screed floor box with cable exit

0896 34	Metal in-screed floor box	24686	1
---------	---------------------------	-------	---

#### Accessories for metal in screed floor box

0896 83	Normal load support upto 8 KN load with deflection <6 mm	25148	1
0896 84	Heavy load support up to 20 KN load with deflection <3 mm	42520	1

Bold Cat.Nos are products normally available with Legrand (India) Stockists. Cat.Nos that are not bold - delivery within 4 - 8 weeks from the date of order. Bold packing quantity is our mandatory packing. Orders to be placed by Legrand (India) Stockist in multiples of the same.



# POP-UP BOXES

Our sleek new ergonomically designed pop-up boxes provide real ease of use and rapid connection solutions for mobile applications such as PCs, mobile phones, audio and video systems.



## **SLEEK DESIGN**

Extra-slim format to blend discreetly into the office furniture or floor



Scan to know more about the product.



**SAFETY AND EASE OF USE**

Soft opening cover with damper and push & slide locking system



**ELEGANT FINISHES**

Aluminium, bronze, stainless steel, black or white - a perfect match for furniture and decor



**FUNCTIONALITY AND FLEXIBILITY**

Available in 3, 2x3, 4 and 2x4 modules for custom configuration or ready assembled with low and high current functions

## Heavy duty in-screed floor box for screed floors

Cat.Nos	Description	MRP* ₹ / Unit	Pack
---------	-------------	------------------	------

### Plates for metal in-screed floor boxes

0896 86	IP 66 plate (cover closed and plugs not connected) with central cable exit	87532	1
0896 87	IP 14 Cable exit accessory for IP66 cover plate Cat.No 0896 86 be used as a simple access to the floor void	46770	-

### Over floor trunking

Conform to Std EN 50085-2-2; For creating a link between trunking, column, mini-column, floor units or protecting cables on passageways Supplied with cover

0300 92	Over floor trunking 50 x 12 mm; length 2 m, supplied with cover; 3 Compartments;	588	54 <sup>(1)</sup>
0300 11	Flat angle/floor 50 x 12	232	10
0300 12	Cover joint/floor 50 x 12	294	10
0300 93	Over floor trunking 75 x 18 mm; length 2 m, supplied with cover; 3 compartments;	802	36 <sup>(1)</sup>
0300 18	Flat angle/floor 75 x 18	446	10
0300 19	Cover joint/floor 50 x 12	310	10
0328 00	Over floor trunking 92 x 20 mm; Length 2 m, supplied with cover; 4 Compartments, equipped with 2 adhesive strips for better floor fixing	1470	20 <sup>(1)</sup>
0328 07	End cap for floor duct 92 x 20	260	10
0328 03	Cover joint for floor duct 92 x 20	356	10
0328 02	Flat angle for floor duct 92 x 20	642	5

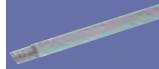

0300 92



0300 93

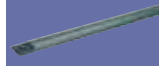

0328 00



0896 44



0896 49



0880 61

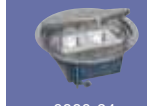

0880 64

## Floor boxes 3 module for screed floor and raised floor

### Floor service outlet boxes - 3 modules

0896 44	Floor service outlet box - 3 modules Grey RAL 7031 To be equipped with Arteor Mechanism	1880	1
0896 49	Flush mounting box for concrete for Cat.No 0896 44	1254	1

### IP 66 Floor box - 4 module

Conform to EN 60670-1 and EN 60670-23 standards (when lid is closed) / IP55 (with cable exit accessory Cat.No 0880 62)

0880 61	IP66/IK09 screwed stainl. steel floor box (with removable lid); can be equipped with cable exit accessory Cat. No 0880 62	20494	1
0880 64	IP66/IK09 hinged cover stainl. steel floor box	24654	1



0893 07



0540 15



0540 16



0540 17



0540 23



0540 34



0540 36

## Floor boxes 3 module for screed floor and raised floor

Cat.Nos	Description	MRP* ₹ / Unit	Pack
---------	-------------	------------------	------

### IP 66 Floor box - 4 module

Conform to EN 60670-1 and EN 60670-23 standards (when lid is closed) / IP55 (with cable exit accessory Cat.No 0880 62)

0880 69	Auto adjustable back box for installing IP66 floor boxes in concrete floors; supplied with cover; accepts conduit dia 20 mm; min screed height 65 mm	3936	1
0880 62	IP55 cable exit accessory	22830	1

## Floor access unit for raised floors

### IP 20 - IK 08

0893 07	Access master box floor box that can be used as a simple access to the floor void	8774	1
---------	---	------	---

## Pop-up type flush-mounting boxes for floor

### Pop-up boxes to be equipped

Equipped with "push and slide" locking system to avoid accidental opening by feet  
To be equipped with Arteor socket outlets  
For installation use the flush-mounting boxes for concrete floors or the kits for raised access floors

### 3 modules

0540 10	Matt aluminium finish	2796	1
0540 15	Brushed brass	4066	1
0540 20	Brushed Stainless steel finish	4116	1

### 4 modules

0540 11	Matt aluminium finish	3748	1
0540 16	Brushed brass	4818	1
0540 21	Brushed Stainless Steel finish	5214	1
0540 26	Matt black	4710	1
0540 31	Glossy white	4822	1

### 6 (2 x 3) modules

0540 12	Matt aluminium finish	6270	1
0540 17	Brushed brass	8732	1
0540 22	Brushed stainless steel finish	9056	1

### 8 (2 x 4) modules

0540 13	Matt aluminium finish	7766	1
0540 18	Brushed brass	10478	1
0540 23	Brushed stainless steel finish	11144	1
0540 28	Matt black	10098	1
0540 33	Glossy white	10156	1

### Retractable accessory for Pop Up

0540 34	RJ45 Cat 6 UTP retractable Kit - 1 module	3896	1
0540 35	RJ45 Cat 6 FTP retractable Kit - 1 module	5448	1
0540 36	USB/ Micro-USB Retractable Kit - 1 module	3692	1

\* MRP - Maximum Retail Price Inclusive of all taxes including GST.  
(1) Price in Meters; No of meters in Pack, Standard length 2 meters to be ordered in multiple of 2 meters.

Bold Cat.Nos are products normally available with Legrand (India) Stockists. Cat.Nos that are not bold - delivery within 4 - 8 weeks from the date of order. Bold packing quantity is our mandatory packing. Orders to be placed by Legrand (India) Stockist in multiples of the same.

## Pop-up type flush-mounting boxes for floor

Cat.Nos	Description	MRP* ₹ / Unit	Pack
---------	-------------	------------------	------

### Installation kits for raised access floors

Include an empty receptacle and fixing brackets for raised access floor tiles Compatible with:

- Cat. 6 data cabling
- Audio/video cabling

0540 05	3 modules	1276	1
0540 06	4 modules	1530	1
0540 07	6 (2 x 3) modules	2120	1
0540 08	8 (2 x 4) module	2614	1



0540 06

### For installation of pop-up floor boxes in concrete floors

Equipped with knockouts for ø 20 and ø 25 mm conduits

#### Metal flush-mounting boxes

0540 00	3 modules	342	1
0540 01	4 modules	456	1
0540 02	6 (2 x 3) modules	724	1
0540 03	8 (2 x 4) modules	908	1



0540 00

## Pop-up type flush-mounting boxes for furniture

### Pop-up boxes to be equipped

Slim design for perfect integration into the furniture  
To be equipped with Arteor socket outlets  
Supplied alongwith installation kits for table top

#### 4 modules

<b>6540 14</b>	Matt Aluminium	3670	1
6540 00	Matt steel finish	4902	1
6540 01	Glossy White	4538	1
6540 02	Matt Black	4340	1



6540 00

#### 8 (2 x 4) modules

<b>6540 15</b>	Matt Aluminium	7602	1
6540 03	Matt steel finish	10608	1
6540 04	Glossy White	9656	1
6540 05	Matt Black	9600	1

## Power & data desk grommets for workstation & meeting room table application

### Empty power & data desk grommets

To be equipped with Arteor socket outlets, Easily retro fitted into a 60 to 80 mm diameter hole in current office desks and workspace table tops (by replacing the desk grommet)  
Cover opens to 180° angle to prevent breaking

#### For one 2P+E socket

0540 70*	White RAL 9003, to be equipped with 1 socket	2712	1
0540 71*	Black RAL 9017, to be equipped with 1 socket	2656	1

0540 70  
+ 0540 60

#### For one 2P+E socket and USB phone charger

Supplied with one USB phone charger output

#### 5 V= 750 mA, to be wired

0540 72*	White RAL 9003 with USB, to be equipped with 1 socket	6476	1
0540 73*	Black RAL 9017 with USB, to be equipped with 1 socket	7054	1



0540 73

0540 73  
+ 0540 62

## Power & data desk grommets for workstation & meeting room table application

Cat.Nos	Description	MRP* ₹ / Unit	Pack
---------	-------------	------------------	------

### Pre-wired modules with retractable cords

For fitting on an empty power & data desktop modules (under the table top)  
Automatic cable rewind when not connected, for an optimized use of the desk surface

#### Cat. 6 FTP

0540 65	Equipped with - 1.35 m RJ 45 Cat. 6 FTP retractable cord on the user side and - 1 x RJ 45 socket on the installation side Patch cord for connection to data network to be ordered separately	3962	1
---------	--	------	---



0540 65

#### USB / micro USB

0540 67	Equipped with - 1.35 m retractable cord with micro USB connector, on the user side and - 0.5 m cable with USB connector on the installation side	3586	1
---------	--	------	---



0540 67

### Finishing plates for empty power & data desk grommets

For fitting on an empty power & data desk grommets

0540 60	White RAL 9003	392	10
0540 62	Black RAL 9017	432	10
0540 63	Stainless steel	1572	10



0540 60



0540 62

### Cable worm

0535 98	2 compartments, Length: 0.75 m White colour very suitable solution for a safe and design protection of the cabling between desk and floor	6196	1
---------	---	------	---



0535 98

## Flush mounting power and data module

A ready to embed solution for all dry support with thickness between 2 and 40 mm. Conform to standard NFC 61-314 which ensures safety of the user  
Aesthetic product (no visible screw), thickness of 6mm only.  
Product available in 8 and 12 module, with the option of configuring power sockets, data, AV, protection etc. 3 Finishes; white/ black and aluminium

### Flush mounting power and data module to be equipped

Aluminium extensions with cable guide (reversible)  
To be equipped with Arteor sockets

#### 8 module; length - 180 mm

0535 60	Flush 8 mod white finish	7042	1
0535 61	Flush 8 mod aluminium finish	8310	1
0535 62	Flush 8 mod black finish	6860	1



0535 60

#### 12 module; length - 270 mm

0535 63	Flush 12 mod white finish	7410	1
0535 64	Flush 12 mod aluminium finish	8926	1
0535 65	Flush 12 mod black finish	7474	1

\* MRP - Maximum Retail Price Inclusive of all taxes including GST.

\* Finishing Plates to be ordered separately

Red Cat.Nos - new products

Bold Cat.Nos are products normally available with Legrand (India) Stockists. Cat.Nos that are not bold - delivery within 4 - 8 weeks from the date of order. Bold packing quantity is our mandatory packing. Orders to be placed by Legrand (India) Stockist in multiples of the same.



# DLP-S

## UNIVERSAL TRUNKING

### FOR THE ESSENTIALS

- Traditional installation method with modular or with universal supports
- Compatible with all types of 45 mm mechanisms (like Arteor)

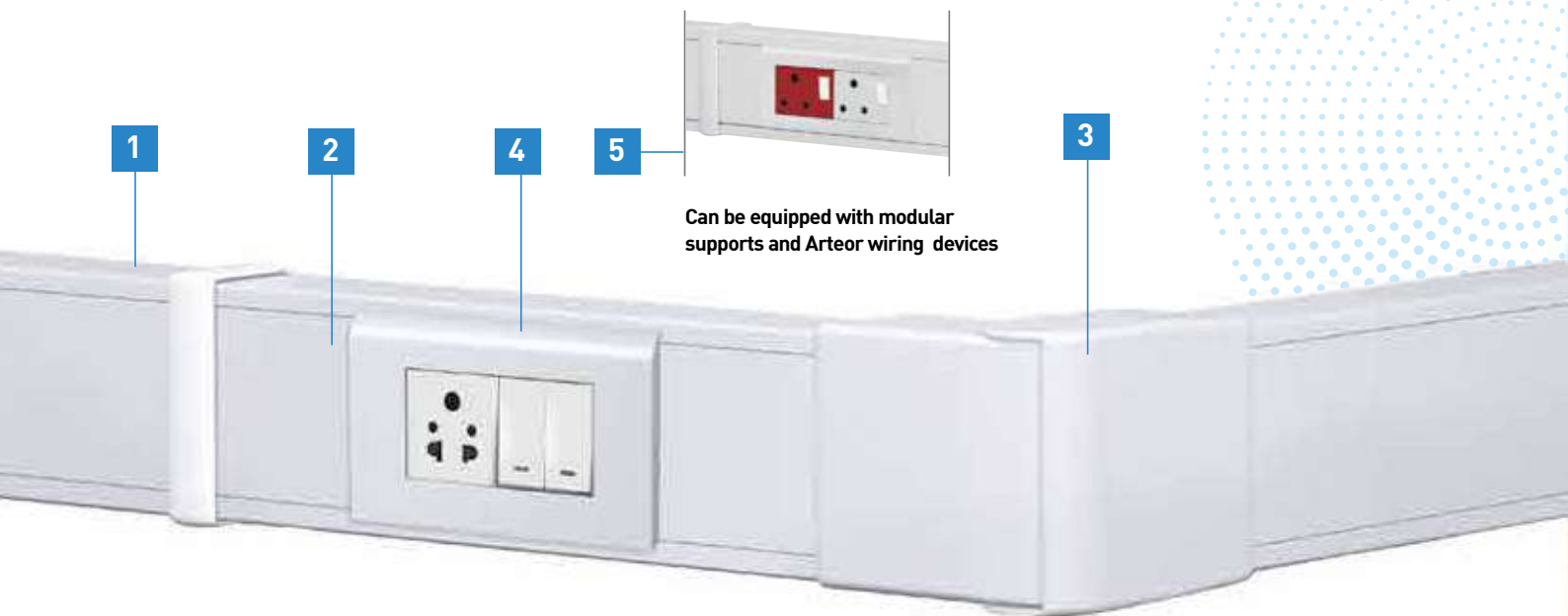

1 Rigid profiles with perforations



2 Self-guiding cover

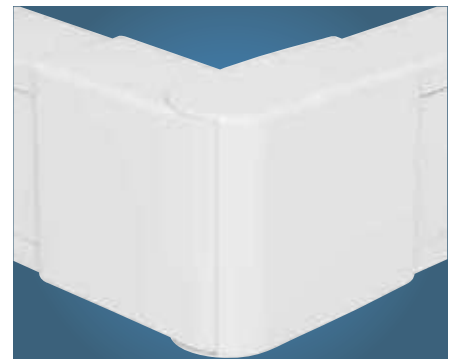

3 Ready to install accessories



Scan to know more about the product.



**4** Myrius single module switch with brackets



**5** Arteor sockets and modular support

## snap-on trunking

routing sections and accessories

TRUNKING			TRUNKING		
Number of compartments	Cover width	Cross-section (mm)	Monobloc: body + cover <sup>1)</sup>	Divider	Fishplate body joint
<b>SNAP-ON TRUNKING - 45 mm cover</b>					
	45	<b>50 x 80</b>	○ 0756 01	0756 09	0756 61
	45	<b>50 x 105</b>	0756 02	0756 09	0756 62
	45 45	<b>50 x 130</b>	0756 03	-	0756 61
	45 45	<b>50 x 145</b>	0756 04	-	0756 63
	45 45 45	<b>50 x 180</b>	0756 06	-	0756 61
<p>1: Partition(s) integral to the body                  2: Internal and external corner angles supplied with multi-compartment partition joint</p>					

## mechanisms for snap-on trunking

Mounting functions		
The Arteor sockets to be fitted with Soluclip accessory which has following features: - Anti-slip - Anti-pullout - IP 4X - Perfect finish		0756 90

### Installation principle for sockets for snap-on trunking

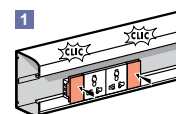

Snap the sockets directly into the trunking

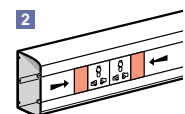

Install the covers

### Installation principle for Arteor functions

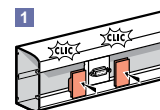

Snap on the mechanism and fix with Soluclips

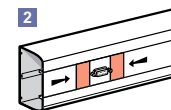

Install the covers

AND ACCESSORIES			ANGLES			JUNCTIONS				ACCESSORIES
Stick-on body joint	Cover joint	End cap	Internal angles <sup>(2)</sup>	External angles	Flat angles	Flat junctions with width 80 mm	Flat junctions with width 105 mm	Angled junctions 85/105/130 mm	Junction with floor duct 50 x 12/92 x 20	Extra cover
0756 66	0756 69	0756 11	0756 21	0756 31	0756 41	0756 71	-	0756 81 + 0756 21	0756 88	0756 08
0756 67	0756 69	0756 12	0756 22	0756 32	0756 42	0756 72	0756 76	0756 81 + 0756 22	0756 88	0756 08
0756 66	2 x 0756 69	0756 13	0756 23	0756 33	0756 43	0756 71	0756 75	0756 81 + 0756 23	0756 88	0756 08
① 0756 66 + ② 0756 67	2 x 0756 69	0756 14	0756 24	0756 34	0756 44	① 0756 71 + ② 0756 72	① 0756 75 + ② 0756 76	0756 81 + 0756 24	0756 88	0756 08
0756 66	3 x 0756 69	0756 16	0756 26	0756 36	0756 46	0756 71	0756 75	0756 81 + 0756 26	0756 88	0756 08

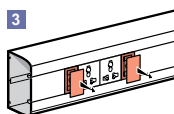

Disengage the finishing piece

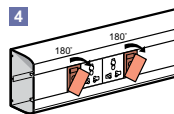

Rotate the finishing piece by 180°

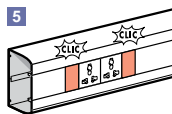

Snap on the finishing piece

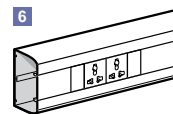

An impeccable result

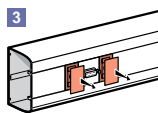

Disengage the finishing piece

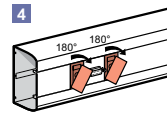

Rotate the finishing piece by 180°

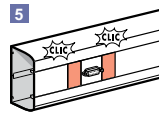

Snap on the finishing piece

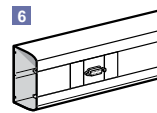

























An impeccable result







## DLP PVC adaptable trunking systems for installations base, covers, partitions, finishing accessories and mounting wiring accessories

Selection chart for Installation of trunking, Accessories and Arteor™

Trunking			Covers		Clip on partition		Arteor™ frames				
Number of compartments	Cover(s) width	Section (mm)									
			Flexible	Partitions separation	Plastic	Aluminium	1 module	2 module	3 module	4 module	6 module
 <b>0104 12</b>	1 	<b>80 x 50</b>	0105 21	0105 82	-	-	-	0109 52	0109 53	0109 54	0109 56
	2 		0105 20	0105 82	0104 72	0111 06	0109 10	-	-	-	-
 <b>0104 32</b>	1 	<b>150 x 50</b>	0105 24	0105 82	-	-	-	-	-	-	-
	2 		0105 21	0105 82	0104 72	0111 06	-	0109 52	0109 53	0109 54	0109 56
	2 		0105 20 + 0105 22	0105 82	0104 72	0111 06	0109 10	0109 92	0109 93	0109 94	0109 96
	3 		0105 20	0105 82	0104 72 x 2	0111 06 x 2	0109 10	-	-	-	-
 <b>0104 52</b>	1 	<b>195 x 50</b>	0105 26	0105 82	-	-	-	-	-	-	-
	2 		0105 22	0105 82	0104 72	0111 06	-	0109 92	0109 93	0109 94	0109 96
	2 		0105 82	0104 72	0111 06	0109 10	-	-	-	-	
	3 		0105 82	0104 72 x 2	0111 06 x 2	0109 10	0109 92	0109 93	0109 94	0109 62	
	3 		0105 82	0104 72 x 2	0111 06 x 2	0109 10	0109 52	0109 53	0109 54	0109 56	
	4 		0105 20	0105 82	0104 72 x 3	0111 06 x 3	0109 10	-	-	-	-

Selection chart for Installation trunking, Accessories and Arteor™

Section (mm)	Wall crossing 	Capacity change 	Partition junction 	Cable tie base 	Insulating unit for Arteor™ modules 	Earth Link
					2 Module Combined to get 4/6 Module	
80 x 50 / 105 x 50	0106 98	0106 87 + 0106 88 + 0106 89 (to be used for partition)	0106 89	0308 81	0109 27	0111 88
150 x 50 / 195 x 50	0106 99					

### Selection chart for Installation of trunking, Additional accessories

Cover	Bases		Internal angles 80° - 100°			External angles 60° - 120°			Flat angles		Flat junction			
Joint for covers	Base joint	End caps	Angles	Partition junction	VDI access.	Angles	Partition junction	VDI access.	Angles	VDI access.	Angles	Partition junction	VDI access.	Clips
0108 01	0106 91	0107 22	0106 02	-	0107 80	0106 22	-	0107 81	0107 67	0107 82	0107 32	-	0107 83	0106 82
0108 02	0106 91	0107 02	0106 02	-	0107 80	0106 22	-	0107 81	0107 85	0107 82	0107 32	-	0107 83	0106 82
0108 00	0106 91	0107 02	0106 02	0106 11	-	0106 22	0106 32	-	-	-	0107 32	0107 42	-	0106 82
0108 04	0106 91	0107 06	0106 02	-	-	0106 22	-	-	0107 89	-	0107 32	-	-	0106 86
0108 01	0106 91	0107 06	0106 02	0106 11	0107 80	0106 22	0106 32	0107 81	0107 89	0107 82	0107 32	0107 42	0107 83	0106 82
0108 02	0106 91	0107 06	0106 02	0106 11	0107 80	0106 22	0106 32	0107 81	0107 89	0107 82	0107 32	0107 42	0107 83	0106 82
0108 00	0106 91	0107 06	0106 02	0106 11 x2	-	0106 22	0106 32 x2	-	0107 89	-	0107 32	0107 42	-	0106 82
0108 06	0106 91	0107 07	0106 02	-	-	0106 22	-	-	0107 92	-	0107 32	-	-	0106 86
0108 02	0106 91	0107 07	0106 02	0106 11	0107 80	0106 22	0106 32	0107 81	0107 92	0107 82	0107 32	0107 42	0107 83	0106 82
	0106 91	0107 07	0106 02	0106 11	0107 80	0106 22	0106 32	0107 81	0107 92	0107 82	0107 32	0107 42	0107 83	
	0106 91	0107 07	0106 02	0106 11 x2	0107 80	0106 22	0106 32 x2	0107 81	0107 92	0107 82	010732	0107 42	0107 83	0106 82
	0106 91	0107 07	0106 02	0106 11 x2	0107 80	0106 22	0106 32 x2	0107 81	0107 92	010782	0107 32	0107 42	010783	0106 82
0108 00	0106 91	0107 07	0106 02	0106 11 x3	-	0106 22	0106 32 x3	-	0107 92	-	0107 32	0107 42	-	0106 82

## DLP mini trunking systems for cable distribution







### ■ Selection chart for DLP mini trunking

	Length	Finishing Accessories				Junction Elements
WHITE	2 m	End cap	Internal angle	External angle	Flat angle	Flat junction
32 x 12.5	0300 15	0312 03	0302 51	0302 51	0302 53	0302 54
32 x 16	0308 04	0312 07	0333 25	0333 25	0333 27	0333 30
32 x 20	0300 17	0312 09	0302 71	0302 71	0302 73	0302 74



## DLP aluminium trunking system

selection chart of sections, covers and accessories  
selection chart of support for wiring accessories

### TRUNKING AND ACCESSORIES

				Rigid covers 					Trunking 		
Width (mm)	Nos. of compartments	Covers width	Cat. nos.	65 mm width	85 mm width	130 mm width	180 mm width			Cover Joint	Base Joint
105 x 50	1 	1 x 85	111 00	-	0111 11	-	-	0111 63	0111 66		
150 x 50	2 	2 x 65	0111 02	2 x 0111 10	-		-	0111 62	0111 66		
195 x 50	2 	2 x 85	0111 04	-	2 x 0111 11	-	-	0111 63	0111 66		

### SUPPORT FOR WIRING ACCESSORIES

60 mm fixing centers : Arteur™	Cover depths	
No of module	65 mm	85 mm
2 modules 	0112 02	0112 12
3 modules 	0112 03	0112 13
4 modules 	0112 04	0112 14
6 modules 	0112 06	0112 16

Insulation resistance : the entire DLP range, including accessories, have insulation resistance above 5 Megaohms

## DLP TRUNKING SYSTEM ALUMINIUM

with aluminium adaptable DLP trunking,  
get better styling too !



### SELECTION CHART OF ACCESSORIES (continued)

Dividers		End cap	Internal angles	External angles	Flat angles	Junction Flat junction*	Clips	Earth link
Clip-on partition	Separation partition							
-	0111 08	0111 58	0112 21	0112 32	0112 43	0112 51	0106 82	0111 88
0111 06	0111 08	0111 60	0112 27	0112 38	0112 45	0112 51	0106 82	0111 88
0111 06	0111 08	0111 61	0112 29	0112 40	0112 47	0112 51	0106 82	0111 88

(1) To be used with angle covers. (2) To be used with rigid covers

### TABLE OF CAPACITIES

	Crosssection (mm <sup>2</sup> ) Max. Ø (mm <sup>2</sup> )	105 x 50	150 x 50		195 x 50	
		cover 85	cover 65	cover 65	cover 85	cover 85
Trunking only	Cross-section	4330	3020	3020	5350	5350
	Max. Ø	28	43	43	55	55
With Arteor / support	Cross-section	2300	1470	1470	3320	3320
	Max. Ø	2 x 24	18	18	33	33

\*To tap off 105 mm wide trunking with 85 mm cover

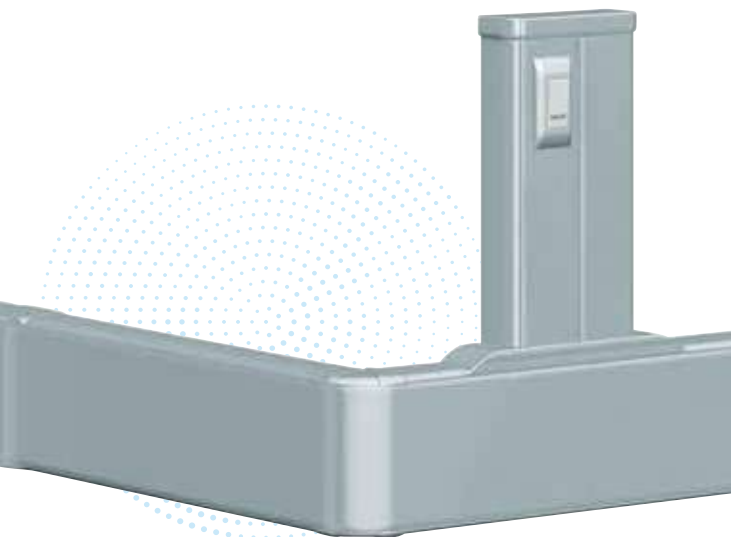

### SAVE TIME

- Flexibility : multi-covers
- Removable separation
- Angles delivered pre-cut, ready to use
- Fast fixing device support
- Uniform colours for the entire installation
- Arteor™ wiring accessories go with aluminium adaptable DLP trunking



## Snap-on trunking routing sections and accessories

Cat.Nos	Description	MRP* ₹ / Unit	Pack
---------	-------------	------------------	------

### Snap-on trunking

**Monobloc: Body + Cover, can take any Arteor wiring accessory**  
Standard length 2 meters; Price per meter

0756 01	Snap-on trunking 50 x 80 1 - compartment	1256	20 <sup>(1)</sup>
0756 02	Snap-on trunking 50 x 105 1 - compartment	1598	12 <sup>(1)</sup>
0756 03	Snap-on trunking 50 x 130 2 - compartments	2198	12 <sup>(1)</sup>
0756 04	Snap-on trunking 50 x 145 2 - compartments	2836	8 <sup>(1)</sup>
0756 06	Snap-on trunking 50 x 180 3 - compartments	3122	8 <sup>(1)</sup>

### Divider

0756 09	Divider	276	26 <sup>(1)</sup>
---------	---------	-----	-------------------

### Extra cover

0756 08	Width 45 mm	490	20 <sup>(1)</sup>
---------	-------------	-----	-------------------

### Joints

#### Fishplate Body joint

0756 61	Set of 2 Body joints	442	10
0756 62	Set of 2 Body joints	586	10
0756 63	Set of 2 Body joints	514	10

#### Stick-on body joint

0756 66	For top part of body	286	20
0756 67	For bottom part of body	346	20

#### Cover joint

0756 69	Cover joint, width 45 mm	152	10
---------	--------------------------	-----	----

#### End caps

0756 11	Left or right end cap	256	10
0756 12	Left or right end cap	256	10
0756 13	Left or right end cap	424	5
0756 14	Left or right end cap	438	5
0756 16	Left or right end cap	478	5

#### Height spacer

0105 80	Colour charcoal grey for fitting 15 mm from the ground	644	24 <sup>(1)</sup>
---------	--	-----	-------------------

### Soluclip accessory

#### Fishplate body joint

0756 90	For installation with any Arteor function	222	10
---------	---	-----	----

### Angles

#### Internal angles

0756 21	varies from 80° to 100°	586	10
0756 22	varies from 80° to 100°	818	10
0756 23	varies from 80° to 100°	1374	5
0756 24	varies from 80° to 100°	2206	5
0756 26	varies from 80° to 100°	1950	5

#### External angles

0756 31	varies from 85° to 120°	1224	10
0756 32	varies from 85° to 120°	1870	10
0756 33	varies from 85° to 120°	2540	5
0756 34	varies from 85° to 120°	2994	5
0756 36	varies from 85° to 120°	3550	5

#### Flat angles

0756 41	Flat angle at 90°	716	10
0756 42	Flat angle at 90°	940	10
0756 43	Flat angle at 90°	1870	5
0756 44	Flat angle at 90°	1754	5
0756 46	Flat angle at 90°	3506	5

## Snap-on trunking routing sections and accessories

Cat.Nos	Description	MRP* ₹ / Unit	Pack
---------	-------------	------------------	------

### Junctions

#### Flat junctions with 80 mm width

0756 71	Creates a junction	980	5
0756 72	Creates a junction	980	5

#### For 105 mm wide upward trunking

0756 75	Creates a junction	960	5
0756 76	Creates a junction	1048	5

#### Angled junction

Must be used in conjunction with an internal angle

0756 81	Creates a junction in an internal angle	2164	5
---------	---	------	---

#### Junction with floor duct

0756 88	Creates a junction with a floor duct size 50 x 12 mm or 92 x 20 mm	1138	5
---------	--	------	---

## DLP PVC trunking system

### Mini-trunking system

Standard length 2 meters; Price per meter  
Mini-trunking - 32 x 12.5 mm

0300 15	Without central partition	136	80 <sup>(1)</sup>
---------	---------------------------	-----	-------------------

### Finishing accessories

0312 03	End cap right or left	74	20/400
0302 51	Changeable internal - external angle from 60° to 120°	100	10/100
0302 53	Changeable flat angle from 85° to 95°	112	10/100
0302 54	Flat junction	146	10/200
0336 03	White 32 x 10/12.5 Cover Joint	144	20

### Mini-trunking - 32 x 16 mm

0308 04	Without central partition	178	60 <sup>(1)</sup>
---------	---------------------------	-----	-------------------

### Finishing accessories

0312 07	End cap right or left	106	10
0333 25	Changeable internal - external angle from 60° to 120°	122	10
0333 27	Changeable flat angle from 85° to 95°	120	10
0333 30	Flat junction	168	10
0336 04	White 32 x 16/20 Cover Joint	144	20

### Mini-trunking - 32 x 20 mm

0300 17	Without partition	194	50 <sup>(1)</sup>
---------	-------------------	-----	-------------------

### Finishing accessories

0312 09	End cap right or left	152	10
0302 71	Changeable internal - external angle from 60° to 120°	146	10
0302 73	Changeable flat angle from 85° to 95°	122	10
0302 74	Flat junction	144	10
0336 04	White 32 x 16/20 Cover Joint	144	20

\* MRP - Maximum Retail Price Inclusive of all taxes including GST.  
(1) Price in Meters; No of meters in Pack, Standard length 2 meters to be ordered in multiples of 2 meters

Bold Cat.Nos are products normally available with Legrand (India) Stockists. Cat.Nos that are not bold - delivery within 4 - 8 weeks from the date of order. Bold packing quantity is our mandatory packing. Orders to be placed by Legrand (India) Stockist in multiples of the same.

## DLP PVC trunking system and accessories - trunking and fittings

Cat.Nos	Description	MRP* ₹ / Unit	Pack
---------	-------------	------------------	------

### Standard length 2 meters; Price per meter Trunking

#### Bodies

Supplied without cover

0104 12	80 x 50 mm	786	20 <sup>(1)</sup>
0104 22	105 x 50 mm	980	20 <sup>(1)</sup>
0104 32	150 x 50 mm	1660	10 <sup>(1)</sup>
0104 52	195 x 50 mm	2214	8 <sup>(1)</sup>

#### Flexible cover

Fits onto the whole branch including in internal or external angles

0105 20	Full covers width 40 mm	394	20 <sup>(1)</sup>
0105 21	Full cover width 65 mm	382	24 <sup>(1)</sup>
0105 22	Full cover width 85 mm	442	20 <sup>(1)</sup>
0105 24	Full cover width 130 mm	940	8
0105 26	Full cover width 180 mm	1198	8 <sup>(1)</sup>

#### Partitions

0105 82	Separation partition	262	24 <sup>(1)</sup>
0104 72	Clip-on partition - Plastic	382	48 <sup>(1)</sup>
0111 06	Clip-on partition - Aluminium	1544	12 <sup>(1)</sup>

#### Joints

0106 91	Body / Base joint - For aligning bases during installation	86	20/200
0108 00	Cover joint for 40 mm width	182	10/100
0108 01	Cover joint for 65 mm width	152	10/100
0108 02	Cover joint for 85 mm width	234	10/100
0108 04	Cover joint for 130 mm width	396	10/100
0108 06	Cover joint for 180 mm width	364	10/100

#### Angles and end caps

##### Internal and external angles

Include the 2 components for the top and bottom of the trunking on which the flexible cover is fitted

0106 02	Internal angle, adjustable from 80° to 100°	562	10/40
0106 22	External angle, adjustable from 60° to 120°	548	10/50

##### Flat angle

0107 67	90° flat angle	782	10
0107 85	90° flat angle	818	10
0107 89	90° flat angle	2710	5
0107 92	90° flat angle	3474	2

##### End cap

0107 02	Left or right end cap	200	20/100
0107 06	Left or right end cap	394	10/50
0107 07	Left or right end cap	466	5/50
0107 22	Left or right end cap	222	10

#### Junctions

0107 32	Flat junctions to tap-off to a branch smaller than 50 x 105	1010	10
0107 35	For specific size tap-off to 80 mm wide branch	588	5
0107 36	For tap-off to an 105 mm wide branch equipped with an 85 mm cover	584	5/25
0107 37	Flat junction for specific size - tap off to an 105 mm wide branch with 65 mm cover	584	5/25

\* MRP - Maximum Retail Price Inclusive of all taxes including GST.  
(1) Price in Meters; No of meters in Pack, Standard length 2 meters to be ordered in multiples of 2 meters

## DLP PVC trunking system and accessories - trunking and fittings

Cat.Nos	Description	MRP* ₹ / Unit	Pack
---------	-------------	------------------	------

#### Junctions

##### Partition junction

0106 11	For internal angles	340	5/50
0106 32	For external angles	514	5/50
0107 42	For flat angles	1210	5/25

#### Accessories

##### Holding cables in place

0106 82	Clip for 65 mm width cover	76	50
0106 86	Clip for 130 mm width cover	130	50

##### VDI accessories

0107 80	For internal angles	874	5/50
0107 81	For external angles	942	5/50
0107 82	For flat angles	1002	5/50
0107 83	For flat junctions	1206	5/50

##### Additional accessories

0106 98	Wall crossing for trunking 80 to 150 mm width	974	5/25
0106 99	Wall crossing for trunking 195 mm width	1010	5/25
0308 81	Cable tie base	32	100/1000
0111 88	Earthing link	372	20/500

#### Capacity Change

Allows to increase 15 mm height of trunking to preserve the space of wiring with a flat junction or a support equipment

0106 87	Raise, length 57 cm	352	40
0106 88	Set of 4 accessories to change capacity of the body	444	10/100
0106 89	Set of 2 accessories to change height of partition (to be used)	446	5/50

#### Supports for mounting wiring accessories

##### Arteor™ supports

To be equipped with Arteor socket outlets  
Clip-on supports which can be fitted side by side  
Supplied with finishing plate

0109 10	1 modules-for 40 mm cover	202	5/50
0109 52	2 modules-for 65 mm cover	196	20
0109 92	2 modules-for 85 mm cover	206	20
0109 53	3 modules-for 65 mm cover	270	5/50
0109 93	3 modules-for 85 mm cover	286	5/50
0109 54	4 modules-for 65 mm cover	304	10/50
0109 94	4 modules-for 85 mm cover	314	20
0109 56	6 modules-for 65 mm cover	324	5/25
0109 96	6 modules-for 85 mm cover	398	10
0109 27	Insulation unit for 2 modules (Arteor™) can be fitted together to create 4/6/8 module supports	342	10/100

##### Legrand Lexic supports

0109 25	For 2 modules for 65 mm cover (2 comp.)	1194	5
0109 35	For 3 modules for 85 mm cover (2 comp.)	1406	5
0109 65	For 6 modules for 130 mm cover (1 comp.)	1582	5
0109 00	Hypra socket support - for 130 mm cover	2300	5

Bold Cat.Nos are products normally available with Legrand (India) Stockists. Cat.Nos that are not bold - delivery within 4 - 8 weeks from the date of order. Bold packing quantity is our mandatory packing. Orders to be placed by Legrand (India) Stockist in multiples of the same.

## DLP-S PVC trunking system and accessories - trunking and fittings

Cat.Nos	Description	MRP* ₹ / Unit	Pack
---------	-------------	------------------	------

Standard length 2 meters; Price per meter

### Trunking

#### Body with cover

6380 38	100 x 50	1130	12 <sup>(1)</sup>
---------	----------	------	-------------------

#### Partition

6380 08	Separation Partition	212	32 <sup>(1)</sup>
---------	----------------------	-----	-------------------

#### Joints

6380 36	Body / Base Joint	70	10
6380 01	Cover joint	186	50

### Angles and end caps

#### Variable angles

6380 31	Variable Internal Angle	438	10
6380 32	Variable External Angle	438	10

#### Fixed angles

6380 11	Fixed Internal Angle	284	20
6380 12	Fixed External Angle	286	20

#### Flat angle

6380 13	Flat Angle	620	16
---------	------------	-----	----

#### End cap

6380 35	End Cap	158	20
---------	---------	-----	----

#### Bracket

6380 05	Universal Bracket (set of 2 pcs.)	134	10/100
---------	-----------------------------------	-----	--------

#### Junction

6380 34	Tee / Flat Junction	1372	5
---------	---------------------	------	---

### Supports for mounting wiring accessories

#### Arteor™ & Myrius supports

Clip-on supports which can be fitted side by side  
Supplied with finishing plate

6380 71	2 modules frame	196	10
6380 72	4 modules frame	280	5
6380 73	6 modules frame	400	5

## DLP aluminium adaptable trunking system

### Body

Standard length 2 meters; Price per meter

0111 00	100 x 50 Supplied without cover	4952	8 <sup>(1)</sup>
0111 02	150 x 50 Supplied without cover allow fitting of partial covers - 2 compartments	6240	4 <sup>(1)</sup>
0111 04	195 x 50 Supplied without cover allow fitting of partial covers - 2 compartments	7318	4 <sup>(1)</sup>

### Cover and partition

0111 10	Rigid cover 65 mm width	1244	16 <sup>(1)</sup>
0111 11	Rigid cover 85 mm width	1632	16 <sup>(1)</sup>
0111 08	Separation partition	856	24 <sup>(1)</sup>
0111 06	Clip on Partition	1544	12 <sup>(1)</sup>

### Finishing accessories

0111 66	Base / Body joint	296	20/100
0111 62	Cover joint - 65 mm	406	10
0111 63	Cover joint - 85 mm	432	10/100
0111 58	End cap	882	20/100
0111 60	End cap	1886	10
0111 61	End cap	2238	10

\* MRP - Maximum Retail Price Inclusive of all taxes including GST.  
(1) Price in Meters; No of meters in Pack, Standard length 2 meters to be ordered in multiples of 2 meters

## DLP aluminium adaptable trunking system - trunking and fittings

Cat.Nos	Description	MRP* ₹ / Unit	Pack
---------	-------------	------------------	------

### Finishing accessories

0112 43	Flat angle for 85 mm cover	7586	10
0112 45	Flat angle for cover 65/130 mm	12774	5
0112 47	Flat angle for cover 85/180 mm	13178	2
0112 32	External angle for 85 mm cover	9458	1
0112 38	External angle 2 cover 65 mm	19586	1
0112 40	External angle 2 covers 85mm	20446	1
0112 21	Internal angle for 85 mm cover	8510	1
0112 27	Internal angle 2 Covers 65 mm	19444	1
0112 29	Internal angle 2 Cover 85 mm	20308	1
0112 51	Flat junction To tap off to 105 mm wide trunking equipped with 85 mm cover	10300	5

### Supports for Arteor™ for cover 85 mm width

To be equipped with Arteor socket outlets

0112 12	2 modules	616	20
0112 13	3 modules	724	20
0112 14	4 modules	726	20
0112 16	6 modules	970	10

### Supports for Arteor™ for cover 65 mm width

To be equipped with Arteor socket outlets

0112 02	2 modules	560	20
0112 03	3 modules	686	20
0112 04	4 modules	714	20
0112 06	6 modules	838	10

### Cabling accessories

0106 82	Clip for 65 mm and 85 mm covers	76	50
0111 88	Earth link	372	20
0308 81	Base for cable ties	32	100

## Aluminium Snap-on Columns

### 2 Compartments mini - columns

	Can be equipped with ovaline kits Cat.Nos 6530 63/64/65		
<b>6530 23</b>	<b>White finish</b> PVC body and covers Height 0.68 m	13350	1
<b>6530 24</b>	<b>Aluminium finish</b> Aluminium body and covers Height 0.68 m	18846	1

### Accessories for 1 or 2 compartments mini - columns

<b>6530 84</b>	Table - white finish	36908	1
<b>6530 86</b>	Movable foot - white finish	24344	1
<b>6530 87</b>	Movable foot - aluminum finish	25602	1
<b>6530 88</b>	Set of 4 wheels with cable holder	16802	1

Bold Cat.Nos are products normally available with Legrand (India) Stockists. Cat.Nos that are not bold - delivery within 4 - 8 weeks from the date of order. Bold packing quantity is our mandatory packing. Orders to be placed by Legrand (India) Stockist in multiples of the same.

## Accessories for 1 or 2 compartments

**NEW!**

Cat.Nos	Description	MRP* ₹ / Unit	Pack
---------	-------------	------------------	------

### Fixing clip

6038 57	Fixing clip - Signal White (Set of 2 pcs.)	280	10
6038 58	Fixing clip -Grey/Anthracite (Set of 2 pcs.)	790	10

### 1 Compartment - 2 sides columns

#### White finish

6530 10	Aluminium body, PVC covers Height 2.70m Can be adapted to a ceiling Height upto 3.9m	35026	1
6530 13	Height 3.9m Can be adapted to a ceiling Height upto 5.1m Aluminium body and covers	45074	1

#### Aluminium finish

6530 11	Height 2.70m Can be adapted to a ceiling Height up to 3.9m Height 3.9m	40832	1
6530 14	Can be adapted to a ceiling height up to 5.1m	51352	1

### 2 compartments columns

#### White finish

6530 30	PVC body & covers Height 2.70m Can be adapted to a ceiling Height upto 3.9m	33924	1
6530 33	Height 3.9m Can be adapted to a ceiling Height up to 5.1m	43822	1

#### Aluminium finish

6530 31	Aluminium body and covers Height 2.70m Can be adapted to a ceiling Height up to 3.9m Height 3.9m	45546	1
6530 34	Can be adapted to a ceiling height up to 5.1m	58892	1

### Finishing kit for telescopic pole for 1 or 2 compartments columns

6530 66	Consists of 2 PVC covers and a balse White finish	2354	1
6530 67	Aluminium finish	2516	1

### Fixing clip

6038 57	Fixing clip-Signal white (set of 2 pcs.)	280	10
6038 58	Fixing clip - Grey/Anthracite (Set of 2 pcs.)	790	10

\* MRP - Maximum Retail Price Inclusive of all taxes including GST.  
(1) Price in Meters; No of meters in Pack, Standard length 2 meters to be ordered in multiples of 2 meters

[www.legrand.co.in](http://www.legrand.co.in)



# Click to discover us

- 1** Legrand (India) - provides all information regarding the groups philosophy, products, organisation etc.
- 2** Products and solutions - complete information about our range of products for residential, commercial and industrial markets.
- 3** Downloads - download catalogues and brochures.



# AUDIO/VIDEO PRETERMINATED SOCKETS

## THE RIGHT SYSTEM TO MEET YOUR NEEDS

A wide range of technologies (HD15, HDMI, DISPLAY PORT, RCA, JACK) to suit the location and the user requirements

### INSTALLATION EXAMPLE WITH HD15 PRETERMINATED SOCKET AND VIDEO PROJECTOR SWITCH

**1** Quick  
installation

**2** Easy  
connection

**3** Optimum  
performance



**1** Infrared ON/STANDBY control for video projector associated with a pushbutton  
Cat.No 0 787 99/5 720 89

**2 3** Preterminated HD15 sockets Cat.No 0 787 77/5 720 97

**4** 10 m male/male HD15 cords Cat.No 0 517 23

**5 6** Male/male HD 15 cords



Scan to know more about  
the product.

## Legrand cabling system LCS<sup>3</sup> category 8

Cat.Nos	Description	MRP* ₹ / Unit	Pack
---------	-------------	------------------	------

### Cat. 8 patch panel equipped with 24 RJ 45 connectors

#### Flat panel

0337 82	STP panel - Metal shielding	■	1
---------	-----------------------------	---	---



0337 82

### Flat 24-connector patch panels - 1 U to be equipped

#### Flat panel with empty cassettes to be equipped with connectors

Equipped with 4 automatic extraction cassette for cat. 5e to cat. 8 RJ 45 connectors



0337 90

0337 90	19" patch panel - 1 U	■	1
---------	-----------------------	---	---

#### Empty flat panel to be equipped with cassette

It can accept a maximum of 4 automatic extraction cassettes:  
- copper  
- fibre optic

0337 91	19" patch panel - 1 U	■	1
---------	-----------------------	---	---

### Angled 24-connector patch panel - 1 U

#### Angled panel to be equipped with connectors

It can accept up to 24 cat. 5e to cat. 8 RJ 45 connectors



0337 92

0337 92	19" panel - 1 U	■	
---------	-----------------	---	--

### Cat. 8 RJ 45 connectors for flat and angled STP panel

0337 85	Set of 6 RJ 45 connectors For installation in the cassettes of flat or angled panels	■	1
---------	--	---	---



0337 85

### Common accessories for flat and angled panels

#### Port blanking modules

0337 56	Divisible 6 port blanking plate for sealing from 1 to 6 ports	■	10
---------	--	---	----



0337 56

#### Cord management

0337 59	2 cord management for use with new generation Quick-Fix They provide side cord management	■	1
---------	--	---	---



0337 59

### Specific accessories for flat panels

#### Cassette for flat panels to be equipped

0337 55	Empty removable cassette to be equipped with connectors. It can accept 6 cat. 5e to cat. 8 connectors.  Extraction by simple pressure of the cassette making installation and maintenance easier	■	1
---------	--	---	---



0337 55

#### Blanking cassette

0337 57	Used to blank the panel	■	1
---------	-------------------------	---	---



0337 57

### Specific accessories for angled panels

#### Angled panel cover

0337 58	For optimised management of the air flow inside the cabinet	■	1
---------	--	---	---



0337 58

\* MRP - Maximum Retail Price Inclusive of all taxes including GST.  
■ Price available on request.  
(1) in meters

## Legrand cabling system LCS<sup>3</sup> category 8

Cat.Nos	Description	MRP* ₹ / Unit	Pack
---------	-------------	------------------	------

### Cat. 8 local network cables

#### F/UTP - 4 pairs

Performance 2000 MHz

0337 86	Length 500 m supplied on drum. Weight 42 kg	■	500 <sup>1</sup>
---------	--	---	------------------

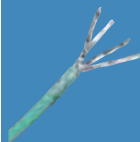

0337 88

#### S/FTP - 4 pairs

Performance 2000 MHz

0337 88	Length 500 m supplied on drum. Weight 45 kg	■	500 <sup>1</sup>
---------	--	---	------------------

### Cat. 8 RJ 45 patch cords

#### S/FTP shielded, impedance 100 Ω

#### LSZH - RAL 6027

0337 01	Length 0.5 m	■	
0337 02	Length 1 m	■	
0337 03	Length 2 m	■	
0337 04	Length 3 m	■	
0337 05	Length 5 m	■	
0337 06	Length 8 m	■	
0337 07	Length 10 m	■	



0337 03

#### LSZH - RAL 3020

0337 21	Length 0.5 m	■	1
0337 22	Length 1 m	■	
0337 23	Length 2 m	■	
0337 24	Length 3 m	■	
0337 25	Length 5 m	■	
0337 26	Length 8 m	■	
0337 27	Length 10 m	■	1

#### LSZH - RAL 6026

0337 08	Length 0.5 m	■	1
0337 09	Length 1 m	■	
0337 10	Length 2 m	■	
0337 11	Length 3 m	■	
0337 12	Length 5 m	■	
0337 13	Length 8 m	■	
0337 17	Length 10 m	■	1

### Marking kit

0518 90	Kit of 200 coloured rings for marking RJ 45 cords Rings to be clipped to the patch cords	■	1
---------	---	---	---



0518 90

## Legrand cabling system LCS<sup>3</sup> category 6<sub>A</sub>

### Cat. 6<sub>A</sub> patch panels equipped with 24 RJ 45 connectors

#### Flat panels

24 RJ 45 connectors - 1 U

0337 70	UTP	■	1
0337 72	STP	■	1



0337 72

Bold Cat.Nos are products normally available with Legrand (India) Stockists.  
Cat.Nos that are not bold - delivery within 4 - 8 weeks from the date of order.  
Bold packing quantity is our mandatory packing. Orders to be placed by  
Legrand (India) Stockist in multiples of the same.

# LCS<sup>3</sup>

## FROM TECHNICAL ROOM TO WORKSTATION

Complete systems with a 20-year guarantee. The new LCS<sup>3</sup> cat. 6a (up to 500 MHz), cat. 6 (up to 250 MHz) and cat. 5e (up to 100 MHz) systems have been designed as coherent entities to optimise their performance. The systems are suitable for optical fibre cables as well as copper cables.

The new LCS<sup>3</sup> systems integrate perfectly in the various other Legrand solutions: DLP trunking system, cabling accessories, cable management, etc.



### FIBRE OPTIC PANELS

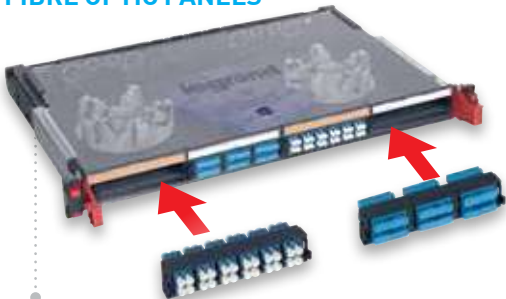

Modular panels

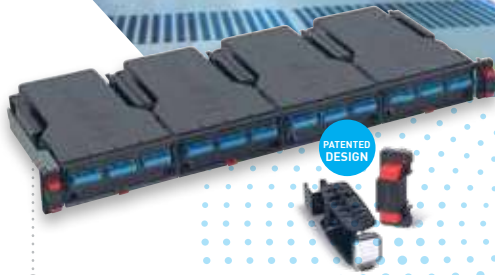

HD Modular panels

### CORD LOCKING SYSTEM



AN INNOVATIVE TECHNICAL SOLUTION

### FIBRE OPTIC SYSTEM

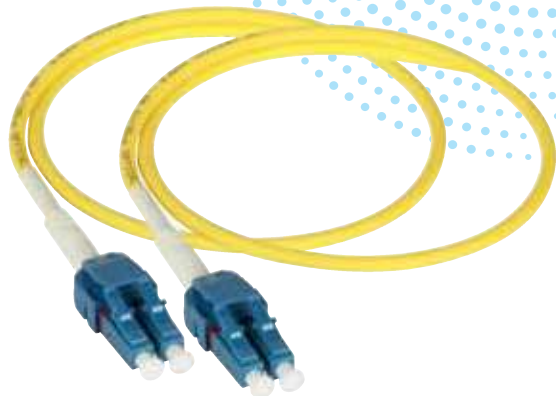

Scan to know more about the product.

## NEW TOOLLESS CONNECTOR CONNECTION PHASES

STEP  
1

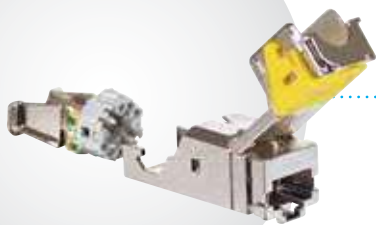

Take the wire housing

STEP  
2

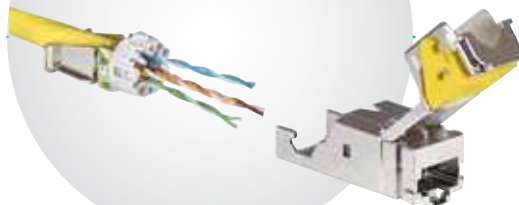

Pass the cable through the back of the wire housing

STEP  
4

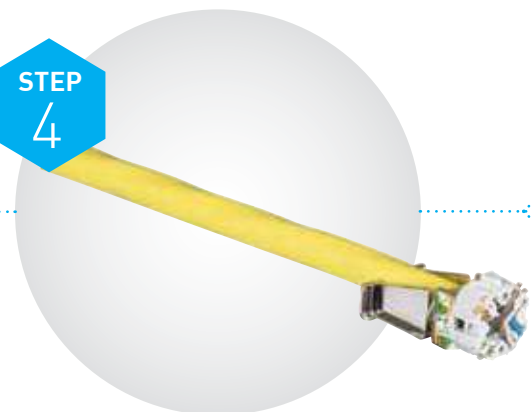

Cut the pairs

STEP  
3

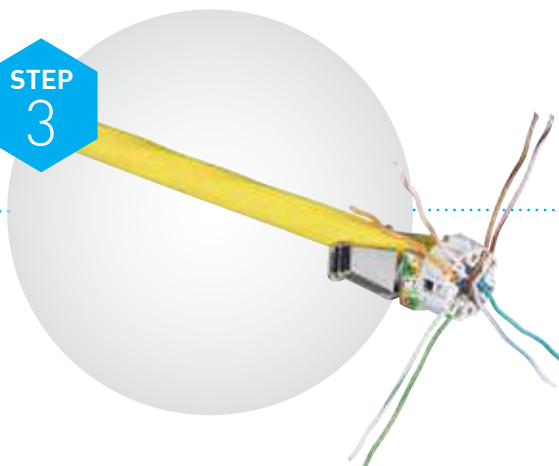

Separate and insert the pairs

STEP  
5



Install the wire housing without pushing

STEP  
6

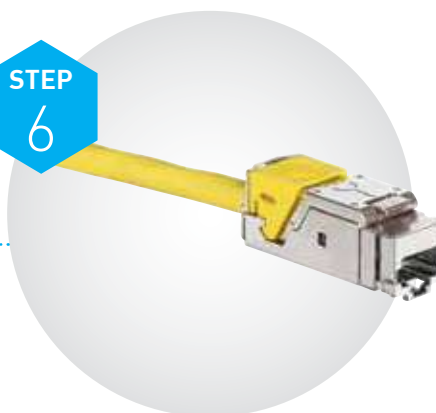

Push down the lever and lock the connector



## Legrand cabling system LCS<sup>3</sup> category 6<sub>A</sub>

Cat.Nos	Description	MRP* ₹ / Unit	Pack
---------	-------------	------------------	------

### Flat 24-connector patch panels - 1 U to be equipped

#### Flat panel with empty cassettes to be equipped with connectors

Equipped with 4 automatic extraction cassettes for cat. 5e to cat. 8 RJ 45 connectors

0337 90	19" panel - 1 U	■	1
---------	-----------------	---	---

#### Empty flat panel to be equipped with cassettes

It can accept a maximum of 4 automatic extraction cassettes:  
- copper  
- fibre optic

0337 91	19" panel - 1 U	■	1
---------	-----------------	---	---

### Flat high density 48-connector patch panel - 1 U to be equipped

0 337 93	19" panel - 1 U	■	1
----------	-----------------	---	---

### Angled 24-connector patch panel - 1 U

#### Angled panel to be equipped with connectors

It can accept up to 24 cat. 5e to cat. 8 RJ 45 connectors

0337 92	19" panel - 1 U	■	1
---------	-----------------	---	---

### Angled high density 48-connector patch panel - 1 U to be equipped

#### Angled panel to be equipped with connectors

It can accept up to 48 cat. 5e to cat. 6A RJ 45 connectors

0337 94	19" panel - 1 U	■	1
---------	-----------------	---	---

### High density cat. 6A RJ 45 connectors

0337 73	UTP	■	1
0337 75	STP	■	1

### Common accessories for flat and angled panels

#### Port blanking modules

0337 56	Divisible 6 port blanking plate for sealing from 1 to 6 ports	■	10
---------	---	---	----

#### Cord management

0337 59	For use with new generation Quick-Fix; they provide side cord management	■	1
---------	--	---	---

### Specific accessories for flat panels

#### Cassette for flat panels to be equipped

0337 55	Empty removable cassette to be equipped with connectors. It can accept 6 cat. 5e to cat. 8 connectors Extraction by simple pressure of the cassette making installation and maintenance easier Possibility of removing each connector individually	■	1
---------	--	---	---

\* MRP - Maximum Retail Price Inclusive of all taxes including GST.

■ Price available on request.

(1) in meters

## Legrand cabling system LCS<sup>3</sup> category 6<sub>A</sub>

Cat.Nos	Description	MRP* ₹ / Unit	Pack
---------	-------------	------------------	------

### High density cassette for flat panels to be equipped

0337 95	Empty removable cassette to be equipped with connectors; it can accept 12 cat. 5e to cat. 6 <sub>A</sub> connectors Extraction by simple pressure of the cassette, making installation and maintenance easier	■	1
---------	--	---	---

### Blanking cassette

0337 57	Used to blank the panel	■	1
---------	-------------------------	---	---

### Specific accessories for angled panels

#### Angled panel cover

0337 58	For optimised management of the air flow inside the cabinet	■	1
---------	---	---	---

### Cables for local networks cat. 6A

#### LSZH - U/UTP - 4 pairs

Performance 500 MHz

0327 87	Length 500 m Supplied on reel. Weight 25 kg	■	500 <sup>1</sup>
---------	---	---	------------------

#### F/UTP - 4 pairs

Performance 500 MHz

0327 78	Length 500 m Supplied on reel. Weight 25 kg	■	500 <sup>1</sup>
---------	---	---	------------------

#### F/UTP - 2 x 4 pairs

Performance 500 MHz

0328 78	Length 500 m Supplied on reel. Weight 65 kg	■	500 <sup>1</sup>
---------	--	---	------------------

#### S/FTP - 4 pairs

Performance 600 MHz

0327 77	Length 500 m Supplied on reel. Weight 30 kg	■	500 <sup>1</sup>
---------	--	---	------------------

### RJ 45 patch cords and user cords cat. 6A

#### PVC - U/UTP unshielded impedance 100 Ω

0518 82	Length 1 m	■	1
0518 83	Length 2 m	■	1
0518 84	Length 3 m	■	1
0518 85	Length 5 m	■	1

#### LSZH - U/UTP unshielded impedance 100 Ω

0518 78	Length 1 m	■	1
0518 79	Length 2 m	■	1
0518 80	Length 3 m	■	1
0518 81	Length 5 m	■	1
0518 74	Length 1 m	■	1
0518 75	Length 2 m	■	1
0518 76	Length 3 m	■	1
0518 77	Length 5 m	■	1

#### PVC - S/FTP shielded impedance 100 Ω

0518 16	Length 0.5 m	■	1
0517 80	Length 1 m	■	5
0517 81	Length 2 m	■	5
0517 82	Length 3 m	■	5
0517 83	Length 5 m	■	5

Bold Cat.Nos are products normally available with Legrand (India) Stockists. Cat.Nos that are not bold - delivery within 4 - 8 weeks from the date of order. Bold packing quantity is our mandatory packing. Orders to be placed by Legrand (India) Stockist in multiples of the same.



0337 57



0337 58



0327 77



0517 82

0337 90

0337 93

0337 92

0337 94

0337 75

0337 56

0337 59

0337 55

## Legrand cabling system LCS<sup>3</sup> category 6<sub>A</sub>

Cat.Nos	Description	MRP* ₹ / Unit	Pack
---------	-------------	------------------	------

### LSZH - S/FTP shielded impedance 100 Ω

0518 70	Length 1 m	■	1
0518 71	Length 2 m	■	1
0518 72	Length 3 m	■	1
0518 73	Length 5 m	■	1
0518 66	Length 1 m	■	1
0518 67	Length 2 m	■	1
0518 68	Length 3 m	■	1
0518 69	Length 5 m	■	1

### Arteor RJ 45 socket cat. 6<sub>A</sub>

360° metal shielding

#### STP - 1 module

5734 32	White	■	20
5728 06	Magnesium	■	10
5723 52	White with green shutter	■	10
5728 52	Magnesium with green shutter	■	10
5723 51	White with orange shutter	■	10
5728 51	Magnesium with orange shutter	■	10

#### STP with controlled access - 2 modules

Supplied with 2 keys for 5 sockets

5723 50	White with red shutter	■	5
5728 50	Magnesium with red shutter	■	5

#### UTP - 1 module

5723 49	White	■	10
5728 49	Magnesium	■	10
5723 59	White with green shutter	■	10
5728 59	Magnesium with green shutter	■	10
5723 58	White with orange shutter	■	10
5728 58	Magnesium with orange shutter	■	10

#### UTP with controlled access - 2 modules

Supplied with 2 keys for 5 sockets

5723 57	White with red shutter	■	5
5728 57	Magnesium with red shutter	■	5

## Legrand cabling system LCS<sup>3</sup> category 6

### Cat. 6 patch panels equipped with 24 RJ 45 connectors

#### Flat panels

24 RJ 45 connectors - 1 U

0337 60	UTP	■	1
<b>0337 61</b>	FTP	■	1
0337 62	STP	■	1

### Flat 24-connector patch panels - 1 U to be equipped

#### Flat panel with empty cassettes to be equipped with connectors

Equipped with 4 automatic extraction cassettes for cat. 5e to cat. 8 RJ 45 connectors

0337 90	19" panel - 1 U	■	1
---------	-----------------	---	---

\* MRP - Maximum Retail Price Inclusive of all taxes including GST.

■ Price available on request.

(1) in meters

## Legrand cabling system LCS<sup>3</sup> category 6

Cat.Nos	Description	MRP* ₹ / Unit	Pack
---------	-------------	------------------	------

### Empty flat panel to be equipped with cassettes

It can accept a maximum of 4 automatic extraction cassettes:  
- copper  
- fibre optic

0337 91	19" patch panel - 1 U	■	1
---------	-----------------------	---	---

### Flat high density 48-connector patch panel - 1 U to be equipped

0337 93	19" panel - 1 U	■	1
---------	-----------------	---	---

### Angled 24-connector patch panels - 1 U

#### Angled panel to be equipped with connectors

It can accept up to 24 cat. 5e to cat. 8 RJ 45 connectors

0337 92	19" panel - 1 U	■	1
---------	-----------------	---	---

### Angled high density 48-connector patch panel - 1 U to be equipped

#### Angled panel to be equipped with connectors

It can accept up to 48 cat. 5e to cat. 6<sub>A</sub> RJ 45 connectors

0337 94	19" panel - 1 U	■	1
---------	-----------------	---	---

### Cat. 6 high density RJ 45 connectors

0337 63	UTP	■	1
<b>0337 64</b>	FTP	■	1
0337 65	STP	■	1

### Common accessories for flat and angled panels

#### Port blanking modules

0337 56	Divisible 6 port blanking plate for sealing from 1 to 6 ports	■	10
---------	---	---	----

#### Cord management

0337 59	For use with new generation Quick-Fix; they provide side cord management	■	1
---------	--	---	---

### Specific accessories for flat panels

0337 55	Cassette for flat panels to be equipped	■	1
0337 95	High density cassette for flat panels to be equipped	■	1
0337 57	Blanking cassette Used to blank the panel	■	1

### Specific accessories for angled panels

#### Angled panel cover

0337 58	For optimised management of the air flow inside the cabinet	■	1
---------	---	---	---

Bold Cat.Nos are products normally available with Legrand (India) Stockists. Cat.Nos that are not bold - delivery within 4 - 8 weeks from the date of order. Bold packing quantity is our mandatory packing. Orders to be placed by Legrand (India) Stockist in multiples of the same.



5734 32



5723 57



0337 93



0337 92



0337 94



0337 63



0337 56



0337 59



0337 55



0337 95



0337 58



0337 61



0337 90

## Legrand cabling system LCS<sup>3</sup> category 6

Cat.Nos	Description	MRP* ₹ / Unit	Pack
---------	-------------	------------------	------

### Cables for cat. 6 LANs

Cables with 4 pairs or 2 x 4 twisted pairs  
100 ohms. Colour code TIA/EIA  
Conform to standards ISO/IEC 11801  
Ed. 2.0, EN 50173-1 and TIA/EIA 568 C

### LSZH - U/UTP - 4 pairs

0327 54I	Length 305 m. Supplied in cardboard box Weight 16 kg., Violet RAL 4005	■	305 <sup>1</sup>
0328 61	Length 500 m. Supplied on reel. Weight 18 kg. Blue RAL 5015	■	500 <sup>1</sup>

### PVC - U/UTP - 4 pairs

0327 55W	Length 305 m Supplied in cardboard box, Weight 13 kg., White RAL 9003, MOQ 50 Box	■	305 <sup>1</sup>
0327 55	Length 305 m Supplied in cardboard box Weight 13 kg. Blue RAL 5015	■	305 <sup>1</sup>
0327 55O	Length 305 m Supplied in cardboard box, Weight 13 kg., Orange RAL 2008, MOQ 50 Box	■	305 <sup>1</sup>
0327 55G	Length 305 m Supplied in cardboard box, Weight 13 kg., Green RAL 6018/6024, MOQ 50 Box	■	305 <sup>1</sup>

### LSZH - U/UTP - 4 pairs

0327 54I	Length 305 m Supplied in cardboard box. Weight 16 kg	■	305 <sup>1</sup>
0328 61	Length 500 m Supplied on reel. Weight 18 kg	■	500 <sup>1</sup>

### PVC - U/UTP - 4 pairs

0327 55	Length 305m Supplied in cardboard box. Weight 13 kg	■	305 <sup>1</sup>
---------	---	---	------------------

### LSZH - F/UTP - 4 pairs

0328 56	Length 305 m. Supplied on reel. Weight 17 kg	■	305 <sup>1</sup>
0327 56	Length 500 m. Supplied on reel. Weight 25 kg	■	500 <sup>1</sup>

### PVC - F/UTP - 4 pairs

0328 57	Length 305 m Supplied in cardboard box. Weight 17 kg	■	305 <sup>1</sup>
0327 58	Length 500 m Supplied on reel. Weight 25 kg	■	500 <sup>1</sup>

### LSZH - F/UTP - 2 x 4 pairs

0327 76	Length 500 m. Supplied on reel. Weight 48 kg	■	500 <sup>1</sup>
---------	---	---	------------------

### LSZH - SF/UTP - 4 pairs

0327 57	Length 500 m. Supplied on reel. Weight 29 kg	■	500 <sup>1</sup>
---------	---	---	------------------

### PVC - SF/UTP - 4 pairs

0327 59	Length 500 m. Supplied on reel. Weight 30 kg	■	500 <sup>1</sup>
---------	---	---	------------------

\* MRP - Maximum Retail Price Inclusive of all taxes including GST.

■ Price available on request.

(1) in meters

## Legrand cabling system LCS<sup>3</sup> category 6

Cat.Nos	Description	MRP* ₹ / Unit	Pack
---------	-------------	------------------	------

### LSZH - F/FTP - 2 x 4 pairs

0327 98	Length 500 m. Weight 62 kg	■	
---------	----------------------------	---	--

### PVC - F/FTP - 4 pairs

0327 99	Length 500 m. Weight 25,2 kg	■	
---------	------------------------------	---	--

### RJ 45 patch cords and user cords cat. 6

RJ 45 - RJ 45 right

### PVC - U/UTP unscreened impedance 100 Ω

0518 18	Length 0.5 m	■	1
0517 72	Length 1 m	■	1
0517 73	Length 2 m	■	1
0517 74	Length 3 m	■	1
0517 75	Length 5 m	■	1

### LSZH - U/UTP unscreened impedance 100 Ω

0518 62	Length 1 m	■	1
0518 63	Length 2 m	■	1
0518 64	Length 3 m	■	1
0518 65	Length 5 m	■	1
0518 58	Length 1 m	■	1
0518 59	Length 2 m	■	1
0518 60	Length 3 m	■	1
0518 61	Length 5 m	■	1

### PVC - F/UTP screened impedance 100 Ω

0518 15	Length 0.5 m	■	1
0517 62	Length 1 m	■	1
0517 63	Length 2 m	■	1
0517 64	Length 3 m	■	1
0517 65	Length 5 m	■	1

### LSZH - F/UTP screened impedance 100 Ω

0518 54	Length 1 m	■	1
0518 55	Length 2 m	■	1
0518 56	Length 3 m	■	1
0518 57	Length 5 m	■	1
0518 50	Length 1 m	■	1
0518 51	Length 2 m	■	1
0518 52	Length 3 m	■	1
0518 53	Length 5 m	■	1

### PVC - SF/UTP shielded impedance 100 Ω

0517 52	Length 1 m	■	5
0517 53	Length 2 m	■	5
0517 54	Length 3 m	■	5
0517 55	Length 5 m	■	5

Bold Cat.Nos are products normally available with Legrand (India) Stockists.  
Cat.Nos that are not bold - delivery within 4 - 8 weeks from the date of order.  
Bold packing quantity is our mandatory packing. Orders to be placed by  
Legrand (India) Stockist in multiples of the same.

## Legrand cabling system LCS<sup>3</sup> category 6

Cat.Nos	Description	MRP* ₹ / Unit	Pack
---------	-------------	------------------	------

### RJ 45 sockets

Sockets with LCS<sup>3</sup> quick-fixing crimp connector. Take AWG 22 single-core cables up to AWG 26 and AWG 24 multicore cables. Contacts marked with dual colour code and wiring schemes T 568 A and T 568 B. Conforming to standards ISO/IEC 11801 Ed. 2.0, EN 50173-1 and TIA/EIA 568

### Arteor RJ 45 socket cat. 6

#### UTP - 1 module

5734 28	White	■	20
5736 28	Magnesium	■	20
5723 54	White with orange shutter	■	10
5728 54	Magnesium with orange shutter	■	10
5723 55	White with green shutter	■	10
5728 55	Magnesium with green shutter	■	10

#### UTP - 2 modules

5734 74	White	■	10
5736 74	Magnesium	■	10

#### UTP - 2 modules - round

5723 24	White	■	10
5728 24	Magnesium	■	10

#### UTP with controlled access - 2 modules

Supplied with 2 keys for 5 sockets

5723 53	White with red shutter	■	5
5728 53	Magnesium with red shutter	■	5

#### UTP retractable RJ 45 sockets - 4 modules

With integrated retractable cord (0.9 m)  
Winds up automatically with a pushbutton

5723 39	White	■	1
5728 39	Magnesium	■	1

#### FTP - 1 module

5723 22	White	■	10
5728 22	Magnesium	■	10

#### FTP - 2 modules

5734 76	White	■	10
5736 76	Magnesium	■	10

#### Shielded STP - 1 module

5734 34	White	■	10
5736 34	Magnesium	■	10

#### Shielded STP - 2 modules

5734 77	White	■	10
5736 77	Magnesium	■	10

### Mylic RJ 45 socket cat. 6

#### UTP - 1 module

6755 45	White	■	20
---------	-------	---	----

\* MRP - Maximum Retail Price Inclusive of all taxes including GST.

■ Price available on request.

(1) in meters



5736 28



5728 24



6755 45

## Legrand cabling system LCS<sup>3</sup> category 6

Cat.Nos	Description	MRP* ₹ / Unit	Pack
---------	-------------	------------------	------

### Myrius RJ 45 sockets cat. 6

#### UTP - 1 module

6730 55	White	■	20
6731 55	Black	■	20

#### UTP - 2 modules

6730 56	White	■	20
6731 56	Black	■	20

### Soliroc RJ 45 sockets cat. 6 - IK 10

0778 91	IP 20 For at-risk areas or areas with no surveillance FTP socket	■	10
---------	---	---	----

### Plexo RJ 45 sockets cat. 6 - IP 55 closed flap IK 07

Protection against water, dust. For industrial sites

0695 69	FTP socket Grey/white	■	5/100
0695 61	UTP socket Grey/white	■	1/20
0695 81	Adaptor for RJ 45 socket Weatherproofing ensured (IP 44) plug inserted Grey/white	■	1

### Plexo 66 RJ 45 socket cat. 6 - IP 66 - IK 08

#### FTP socket

0904 67	9 contacts Weatherproofing ensured (IP 66) with plug inserted Inclined 90° Grey RAL 7016/T029	■	1
---------	---	---	---

### Patch panels cat. 6

6327 91	24 x RJ 45 connectors, for unshielded keystone	■	1
---------	--	---	---

### Keystone RJ 45 sockets cat. 6

0765 88	Cat 6 UTP socket with fast connection thanks to integrated crimping	■	10
---------	---	---	----

### Surface mounting box

1 or 2 ports

6327 79	For keystone connectors Provides solution for integration of keystone in surface mounting installations	■	20
---------	--	---	----

### Cables for cat 6 LANs 24 AWG

#### U/UTP - 4 Pairs

6327 24	Length 305 m Supplied in cardboard box Weight 16 kg. Dark grey RAL 7037	■	305
6327 24W	Length 305 m Supplied in cardboard box Weight 16 kg. White RAL 9003. MOQ - 50 box	■	305
6327 24O	Length 305 m Supplied in cardboard box Weight 16 kg. Orange RAL 2008 MOQ 50 Box	■	305
6327 24G	Length 305 m Supplied in cardboard box Weight 16 kg. Green RAL 6018 / 6024 MOQ 50 Box	■	305



6730 56



0778 91



0695 69



0904 67



6327 91



0765 88



6327 24

Bold Cat.Nos are products normally available with Legrand (India) Stockists. Cat.Nos that are not bold - delivery within 4 - 8 weeks from the date of order. Bold packing quantity is our mandatory packing. Orders to be placed by Legrand (India) Stockist in multiples of the same.



## Legrand cabling system LCS<sup>3</sup> category 6

Cat.Nos	Description	MRP* ₹ / Unit	Pack
---------	-------------	------------------	------

### Patch cords

RJ 45 - RJ 45  
PVC



0337 51

**U/UTP cat. 6 unscreened impedance 100 Ω**

Light blue

6327 50	Length 1 m	■	20
6327 51	Length 1.5 m	■	20
6327 52	Length 2 m	■	20
6327 53	Length 3 m	■	20
6327 54	Length 5 m	■	20



6327 50

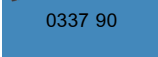

0337 90

**F/UTP cat. 6 screened impedance 100 Ω**

Blue-green

6327 60	Length 1 m	■	20
6327 61	Length 2 m	■	20
6327 62	Length 3 m	■	20
6327 63	Length 5 m	■	20



6327 60



0337 93

## Legrand cabling system LCS<sup>3</sup> category 5e

**Cat. 5e patch panels equipped with  
24 RJ 45 connectors**

**Flat panel with empty cassettes to be equipped with  
connectors**



0337 92

24 RJ 45 connectors - 1 U

0337 50	UTP	■	1
0337 51	FTP	■	1



0337 94

**Flat 24-connector patch panels -  
1 U to be equipped**

**Flat panel with empty cassettes to be equipped with  
connectors**



0337 53

Equipped with 4 automatic extraction cassettes for cat. 5e to  
cat. 8 RJ 45 connectors

0337 90	19" panel - 1 U	■	1
---------	-----------------	---	---



0337 56

**Empty flat panel to be equipped with cassettes**

It can accept a maximum of 4 automatic extraction cassettes:  
- copper  
- fibre optic

0337 91	19" panel - 1 U	■	1
---------	-----------------	---	---



0337 59

**Flat high density 48-connector patch panel -  
1 U to be equipped**

0337 93	19" panel - 1 U	■	1
---------	-----------------	---	---



0337 55

**Angled 24-connector patch panel - 1 U**

**Angled panel to be equipped with connectors**



0337 57

It can accept up to 24 cat. 5e to cat. 8 RJ 45 connectors

0337 92	19" panel - 1 U	■	1
---------	-----------------	---	---



0337 58

**Angled high density 48-connector  
patch panel - 1 U to be equipped**

0337 94	19" panel - 1 U	■	1
---------	-----------------	---	---

\* MRP - Maximum Retail Price Inclusive of all taxes including GST.

■ Price available on request.

(1) in meters

## Legrand cabling system LCS<sup>3</sup> category 5e

Cat.Nos	Description	MRP* ₹ / Unit	Pack
---------	-------------	------------------	------

### Cat. 5e High density RJ 45 connectors

0337 53	UTP	■	1
0337 54	FTP	■	1

### Common accessories for flat and angled panels

#### Port blanking modules

0337 56	Divisible 6 port blanking plate for sealing from 1 to 6 ports	■	10
---------	--	---	----

#### Cord management

0337 59	For use with new generation Quick-Fix They provide side cord management	■	1
---------	--	---	---

### Specific accessories for flat panels

0337 55	Cassette for flat panels to be equipped	■	1
0337 95	High density cassette for flat panels to be equipped	■	1
0337 57	Blanking cassette Used to blank the panel	■	1

### Specific accessories for angled panels

#### Angled panel cover

0337 58	For optimised management of the air flow inside the cabinet	■	1
---------	--	---	---

### Cables for local networks cat. 5e

#### LSZH - U/UTP - 4 pairs

0327 50	Length 305 m Supplied in cardboard box. Weight 16 kg	■	305 <sup>1</sup>
0328 53	Length 500 m Supplied on reel. Weight 15 kg	■	500 <sup>1</sup>

#### PVC - U/UTP - 4 pairs

0327 51	Length 305 m Supplied in cardboard box. Weight 9 kg	■	305 <sup>1</sup>
---------	---	---	------------------

#### LSZH - F/UTP - 4 pairs

0327 52	Length 305 m Supplied in cardboard box. Weight 12 kg	■	305 <sup>1</sup>
0328 50	Length 500 m Supplied on reel. Weight 21 kg	■	500 <sup>1</sup>

#### PVC - F/UTP - 4 pairs

0327 53	Length 305 m Supplied by box. Weight 11 kg	■	305 <sup>1</sup>
---------	---	---	------------------

### RJ 45 patch cords and user cords cat. 5e

RJ 45 - RJ 45 right

#### PVC - U/UTP unscreened impedance 100 Ω

Grey

0518 17	Length 0.5 m	■	1
0516 36	Length 1 m	■	1
0516 37	Length 2 m	■	1
0516 38	Length 3 m	■	1
0516 39	Length 5 m	■	1

Bold Cat.Nos are products normally available with Legrand (India) Stockists.  
Cat.Nos that are not bold - delivery within 4 - 8 weeks from the date of order.  
Bold packing quantity is our mandatory packing. Orders to be placed by  
Legrand (India) Stockist in multiples of the same.

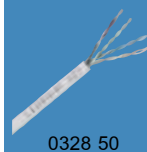

0328 50

## Legrand cabling system LCS<sup>3</sup> category 5e

Cat.Nos	Description	MRP* ₹ / Unit	Pack
---------	-------------	------------------	------

### F/UTP screened impedance 100 Ω

Grey

0516 14	Length 0.5 m	■	1
0516 40	Length 1 m	■	1
0516 41	Length 2 m	■	1
0516 42	Length 3 m	■	1
0516 43	Length 5 m	■	1

### Myrius RJ 45 sockets cat. 5e

#### UTP - 1 module

6730 54	White	■	20
6731 54	Black	■	20

### Mylic RJ 45 sockets cat. 5e

#### UTP - 1 module

6755 47	White	■	20
---------	-------	---	----

### Arteor RJ 45 socket cat. 5e

#### UTP - 1 module

5734 29	White	■	20
5736 29	Magnesium	■	20

#### UTP - 2 modules

5734 75	White	■	10
5736 75	Magnesium	■	20

#### FTP - 1 module

5734 30	White	■	20
5736 30	Magnesium	■	20

### Plexo RJ 45 sockets, cat. 5e - IP 55 closed flap IK 07

Protection against water, dust  
For industrial sites

0695 57	FTP socket Grey/White	■	1/20
0695 56	UTP socket Grey/White	■	1/20
0695 81	Adaptor for RJ 45 socket Ensures weatherproofing (IP 44) with the plug inserted Grey/White	■	1

### Patch panels cat. 5e

6327 91	24 x RJ 45 connectors, for unshielded keystone	■	1
---------	--	---	---

### Keystone RJ 45 sockets cat. 5e

0765 87	Cat 5e UTP socket with fast connection thanks to integrated crimping	■	10
---------	--	---	----

### Surface mounting box

1 or 2 ports

6327 79	For keystone connectors Provides solution for integration of keystone in surface mounting installations	■	20
---------	--	---	----

\* MRP - Maximum Retail Price Inclusive of all taxes including GST.

■ Price available on request.

(1) in meters

## Legrand cabling system LCS<sup>3</sup> category 5e

Cat.Nos	Description	MRP* ₹ / Unit	Pack
---------	-------------	------------------	------

### Patch cords

RJ 45 - RJ 45 - PVC

### U/UTP cat. 5e unscreened impedance 100 Ω

Light pink

6327 30	Length 1 m	■	20
6327 31	Length 1.5 m	■	20
6327 32	Length 2 m	■	20
6327 33	Length 3 m	■	20
6327 34	Length 5 m	■	20

### F/UTP cat. 5e screened impedance 100 Ω

Light brown

6327 40	Length 1 m	■	20
6327 41	Length 2 m	■	20
6327 42	Length 3 m	■	20
6327 43	Length 5 m	■	20

## Legrand cabling system LCS<sup>3</sup> doubler sockets, adaptors and accessories

### RJ 45 doubler sockets

#### Arteor - Telephone/Ethernet

5723 36	FTP - 9 contacts - White	■	10
5728 36	FTP - 9 contacts - Magnesium	■	10
5723 35	UTP - 8 contacts - White	■	10
5728 35	UTP - 8 contacts - Magnesium	■	10

### Mobile doublers

Clip into RJ 45 sockets to double applications

0327 83	TV/computer network or telephone double connector	■	10
0327 47	Telephone/telephone doubler	■	10
0327 45	Computer network/telephone doubler	■	10
0327 46	L1/L2 telephone doubler	■	10
0327 48	Computer network/computer network double connector	■	10

### Weatherproof adaptors

IP 55 - IK 07 - Allow all functions to be adapted  
2 Mosaic modules IP 55 operation

Grey/White

0695 80	Adaptor with smoked flap	■	10
0695 79	Adaptor with smoked flap lockable by special tool	■	1
0695 81	Adaptor for RJ socket ensuring IP 44 waterproofness cable already connected	■	1
0919 45	Locking tool (used for changing vandal-proof screws)	■	1

Bold Cat.Nos are products normally available with Legrand (India) Stockists. Cat.Nos that are not bold - delivery within 4 - 8 weeks from the date of order. Bold packing quantity is our mandatory packing. Orders to be placed by Legrand (India) Stockist in multiples of the same.

## Legrand cabling system LCS<sup>3</sup> doubler sockets, adaptors and accessories

Cat.Nos	Description	MRP* ₹ / Unit	Pack
---------	-------------	------------------	------

### Soliroc adaptor

Used for adapting all functions 2 Mosaic modules

IK 10 - IP 55

0778 80	Adaptor with flap	■	1
0778 81	Adaptor without flap	■	1

### Hypra adaptor

0539 49	IP 55 adaptor base	■	5
---------	--------------------	---	---

### Cable protection accessories

Plastic material

IP 66/67 guaranteed connection with the pair  
Cat.No 0 533 02

IP 55 with no connection for base with blank

Protection for RJ 45 shielded or unshielded cables ensuring a link of category 5

Conform to standards of the IEC 60603-7 series and to standard IEC 61076-3-106 (version 5)

Compatible with products on the market conforming to the standards listed

### Plug

0533 00	Integrated PE with sealing ring and clamping blades Tool-free assembly Ability to protect cables of category 5e	■	3
---------	---	---	---

### Flush-mounting base

0533 01	Locking base Supplied with RJ 45 female/female coupler cat. 5e	■	3
---------	--	---	---

### Kit

0533 02	Flush-mounting base + plug	■	3
---------	----------------------------	---	---

### Protective flap

0533 03	Fits on base Cat.No 0 533 01	■	3
---------	---------------------------------	---	---

### RJ plugs for round cables

Gold-coated contacts 1.2 µm

### RJ 11

0517 01	4 contacts, width 9.65 mm	■	50
---------	---------------------------	---	----

### RJ 12

0517 02	6 contacts, width 9.65 mm	■	50
---------	---------------------------	---	----

### RJ 45 cat. 5e

0517 03	8 contacts, width 11.70 mm	■	50
0517 04	9 contacts, width 11.70 mm	■	50

### RJ 45 sleeves

0517 06	Black	■	50
0517 07	White	■	50

### Stripping tool

Slits the sheath and releases the conductors by rotation

For twisted pair cables

Does not damage the conductors

### Stripper

0332 62	For twisted pair and fibre optic cable	■	1
---------	--	---	---

\* MRP - Maximum Retail Price Inclusive of all taxes including GST.

■ Price available on request.

(1) in meters

## Legrand cabling system LCS<sup>3</sup> doubler sockets, adaptors and accessories

Cat.Nos	Description	MRP* ₹ / Unit	Pack
---------	-------------	------------------	------

### Cutting pliers

0327 60	Cut wires cleanly without damaging the copper	■	1
---------	---	---	---

### Crimping tool for RJ 45 plugs

Used for crimping plugs

RJ 4/6/8/9 contacts

Ratchet control of crimping

mechanism Able to cut and strip cables

0517 09	Tool with 3 crimping points High resistance steel material	■	1
---------	--	---	---

### 110 tool

0332 60	110 tool	■	1
0332 61	Replacement blade	■	1

## Legrand cabling system LCS<sup>3</sup> data and telephone sockets, patch panels, cables

### Telephone sockets

#### RJ 11 and RJ 12 sockets

Equipped with a modular Jack connector with 1/4 turn terminal for fast connection Tap-off possible

5723 00	White - RJ 11, 4 contacts 1 module	■	10
-	Aluminium - RJ 11, 4 contacts - 1 module	■	10
5728 00	Magnesium - RJ 11, 4 contacts - 1 module	■	10
5723 13	White - RJ 11, 4 contacts - 2 modules	■	10
5728 13	Magnesium - RJ 11, 4 contacts - 2 modules	■	10
5723 12	White - RJ 12, 6 contacts - 2 modules	■	10
5728 12	Magnesium - RJ 12, 6 contacts - 2 modules	■	10

### ISDN socket

Self-stripping 1/4 turn terminals for fast connection. Tap-off possible

-	White - 8 contacts, 2.5 mm 2 earth terminal	■	10
---	--	---	----

### Single master - 2 modules

With IDC connection

Conform to British Telecom

5723 10	White	■	10
5728 10	Magnesium	■	10

### Single secondary - 1 module

With IDC connection

Conform to British Telecom

5723 01	White	■	5
5728 01	Magnesium	■	5

Bold Cat.Nos are products normally available with Legrand (India) Stockists. Cat.Nos that are not bold - delivery within 4 - 8 weeks from the date of order. Bold packing quantity is our mandatory packing. Orders to be placed by Legrand (India) Stockist in multiples of the same.

## Legrand cabling system LCS<sup>3</sup> data and telephone sockets, patch panels, cables

Cat.Nos	Description	MRP* ₹ / Unit	Pack
---------	-------------	------------------	------

### Patch panel telephone 50 ports 110 connect

0335 79	19" panel - 1 U	■	1
---------	-----------------	---	---

### Cables for telephone networks cat. 3

PVC sleeve  
Colour white  
Colour code TIA/EIA

#### U/UTP - 50 pairs

0328 91	Length 500 m Supplied on reel	■	1
---------	----------------------------------	---	---

#### U/UTP - 100 pairs

0328 88	Length 500 m Supplied on reel	■	1
---------	----------------------------------	---	---

### Panels and units for incoming telephone

#### Panels assembled - 1 U

Fitted with 4 LCS<sup>3</sup> RJ 45 units of 12 ports with fast tool-free connection

0335 31	3-6/4-5 contacts for digital telephone	■	1
0335 30	4-5/7-8 contacts for analogue telephone	■	1

#### Incoming telephone units for self-assembly panels

Fitted with 12 LCS<sup>3</sup> RJ 45 ports with quick tool-free connection

0335 33	3-6/4-5 contacts for digital telephone	■	2
0335 32	4-5/7-8 contacts for analogue telephone	■	2

## Audio/video system audio/video sockets

### Female HD15 sockets

Used to transmit analogue video streams (VGA, XGA, UXGA depending on graphic card) between a source (computer) and a compatible receiver (video projector, TV, etc)

#### Arteor - Preterminated sockets - 1 module

Equipped with cord, length 15 cm

5720 97	White	■	1
5725 97	Magnesium	■	1

#### Arteor - Screw-type female HD15 sockets - 2 modules

5722 82	White	■	1
5727 82	Magnesium	■	1

#### Arteor - Screw-type female HD15 sockets 2 modules + 3.5 mm Jack

5722 88	White	■	1
5727 88	Magnesium	■	1

#### Arteor - Solder-type female HD15 sockets 1 module

15 pin

5722 79	White	■	1
5727 79	Magnesium	■	1

\* MRP - Maximum Retail Price Inclusive of all taxes including GST.  
■ Price available on request.

## Audio/video system audio/video sockets

Cat.Nos	Description	MRP* ₹ / Unit	Pack
---------	-------------	------------------	------

### HDMI type A sockets

Used to transmit high-definition digital audio/video streams between a source (computer, HD-DVD drive, etc) and a compatible receiver (TV, video projector, etc)

#### Arteor - Preterminated sockets HDMI 1.4 - 1 module

Equipped with cord, length 15 cm

5720 96	White	■	1
5725 96	Magnesium	■	1

#### Arteor - Screw-type sockets HDMI 1.3 - 2 modules

5722 81	White	■	1
5727 81	Magnesium	■	1

### Jack sockets 3.5 mm

3.5 mm Jack connectors can be used to create audio/video links

#### Arteor - Preterminated sockets - 1 module

Equipped with cord, length 15 cm

5720 91	White	■	1
5725 91	Magnesium	■	1

#### Arteor - 4 screw-type female 3.5 mm Jack socket - 1 module

5722 74	White	■	1
5727 74	Magnesium	■	1

#### Arteor - Solder-type female 3.5 mm Jack socket - 1 module

5722 78	White	■	1
---------	-------	---	---

### Display port sockets

Used to transmit high-definition digital audio/video streams between a source (laptop, computer, etc) and a compatible receiver (video projector, TV, etc)

#### Arteor - Preterminated socket - 1 module

Equipped with cord, length 15 cm

5720 90	White	■	1
5725 90	Magnesium	■	1

### Arteor - Female 2 RCA socket

#### Preterminated

Equipped with a 15 cm cord

5720 92	White	■	1
5725 92	Magnesium	■	1

#### Connection via screw terminals

5722 72	White	■	1
5727 72	Magnesium	■	1

### Arteor - Female 3 RCA socket

#### Preterminated

Equipped with a 15 cm cord

5720 93	White	■	1
5725 93	Magnesium	■	1

Bold Cat.Nos are products normally available with Legrand (India) Stockists. Cat.Nos that are not bold - delivery within 4 - 8 weeks from the date of order. Bold packing quantity is our mandatory packing. Orders to be placed by Legrand (India) Stockist in multiples of the same.

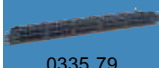

0335 79



5720 96



5720 97



5722 72



## Audio/video system audio/video sockets

Cat.Nos	Description	MRP* ₹ / Unit	Pack
---------	-------------	------------------	------

### Connection via screw terminals

5722 73	White	■	1
5727 73	Magnesium	■	1

5727 73

### Other audio and video sockets

#### Female BNC 75 socket - 1 module

5722 76	White	■	1
5727 76	Magnesium	■	1

5722 76

### Arteor - Audio sockets

#### XLR 3-pin - 2 modules

5722 83	White - Fast screw connection female	■	1
5727 83	Magnesium - Fast screw connection female	■	1
5722 77	White - Fast screw connection male	■	1

5722 83

### Loudspeakers sockets

Terminal 4 mm<sup>2</sup>

5722 80	White - 2 modules	■	10
5727 80	Magnesium - 2 modules	■	10
5722 70	White - 1 module	■	10
5727 70	Magnesium - 1 module	■	10

5727 70

### 100 V Line Volume Attenuators - 2 modules

Used to adjust power and volume of a 100 V loudspeaker line

5722 84	White - 100 V - 25 W	■	1
5727 84	Magnesium - 100 V - 25 W	■	1

5722 84

## Audio/video system audio/video patch panels, cords and cables

### 19" patch panels

0335 98	HD15 19" panel - 12 connectors	■	1
0335 97	HDMI 19" panel - 16 connectors	■	1
0335 96	XLR 19" panel - 16 connectors	■	1
0335 99	SUBD9 19" panel - 12 connectors	■	1

0335 98

0335 96

0335 97

0335 99

### Cords

For connecting a socket to a terminal

#### HD15 cord

0517 23	Length 10 m.	■	1
---------	--------------	---	---

0517 23

#### HD15 cord + 3.5 mm Jack

0517 22	Length 2 m	■	1
---------	------------	---	---

#### HDMI 1.4 cord

0517 26*	Length 1.5 m	■	1
0517 27*	Length 5 m	■	1
0517 20*	Length 10 m	■	1

\* MRP - Maximum Retail Price Inclusive of all taxes including GST.

■ Price available on request.

\* To be introduced shortly.

## Audio/video system audio/video patch panels, cords and cables

Cat.Nos	Description	MRP* ₹ / Unit	Pack
---------	-------------	------------------	------

### HDMI booster

0779 30	Used to extend an HDMI connection.	■	1
---------	------------------------------------	---	---

### XLR cord

0517 24	Length 10 m.	■	1
---------	--------------	---	---



0517 24

### 9-way SUB-D cord

0517 25	Length 10 m.	■	1
---------	--------------	---	---

### Cables

#### VGA cables

0327 81	Length 20 m	■	1
---------	-------------	---	---

#### HDMI cables

0327 80	Length 20 m	■	1
---------	-------------	---	---

## Legrand cabling system LCS<sup>3</sup> fibre optic

### Equipped 19" optic drawers

#### Sliding

0321 61	12 SC duplex multi-mode connectors for 24 fibres	■	1
0321 62	24 LC duplex multi-mode connectors for 48 fibres	■	1
0321 63	24 ST multi-mode connectors for 48 fibres	■	1
0321 64	12 SC duplex single-mode connectors for 24 fibres	■	1
0321 65	24 LC duplex single-mode connectors for 48 fibres	■	1
0321 66	12 SC APC duplex single-mode connectors for 24 fibres	■	1
0321 67	24 LC APC duplex single-mode connectors for 48 fibres	■	1



0321 62

#### Rotating

0321 71	36 LC duplex multi-mode connectors for 72 fibres	■	1
0321 72	18 SC duplex multi-mode connectors for 36 fibres	■	1
0321 73	36 LC duplex single-mode connectors for 72 fibres	■	1
0321 74	18 SC duplex single-mode connectors for 36 fibres	■	1



0321 72

### 19" modular optic drawers

#### Sliding, equipped

0321 02	12 SC duplex multi-mode connectors for 24 fibres	■	1
0321 04	24 LC duplex multi-mode connectors for 48 fibres	■	1
0321 06	12 SC duplex single-mode connectors for 24 fibres	■	1

#### Sliding, to be equipped with fibre optic blocks

It can accept all fibre optic blocks; 4 blocks maximum

0321 00	Empty drawer	■	1
---------	--------------	---	---



0321 00

Bold Cat.Nos are products normally available with Legrand (India) Stockists. Cat.Nos that are not bold - delivery within 4 - 8 weeks from the date of order. Bold packing quantity is our mandatory packing. Orders to be placed by Legrand (India) Stockist in multiples of the same.

## Legrand cabling system LCS<sup>3</sup> fibre optic

Cat.Nos	Description	MRP* ₹ / Unit	Pack
---------	-------------	------------------	------

### Fibre optic blocks

#### Singlemode fibre optic blocks (9/125 µm)

0321 17	ST block for 6 single-mode fibre optics	■	1
0321 10	SC duplex block for 6 single-mode fibre optics	■	1
0321 11	SC duplex high density block for 12 single-mode fibre optics	■	1
0321 12	SC APC duplex block for 6 single-mode fibre optics	■	1
0321 13	LC duplex block for 6 single-mode fibre optics	■	1
0321 14	LC duplex block for 12 single-mode fibre optics	■	1
0321 15	LC duplex high density block for 24 single-mode fibre optics	■	1
0321 16	LC APC duplex block for 12 single-mode fibre optics	■	1
0321 33	Single-mode 4 MTP <sup>1</sup> feedthrough adapter	■	1



0321 15



0321 33

#### Multimode fibre optic blocks (62.5 and 50/125 µm)

0321 27	ST block for 6 multimode fibre optics	■	1
0321 20	SC duplex block for 6 multimode fibre optics	■	1
0321 21	SC duplex high density block for 12 multimode fibre optics	■	1
0321 23	LC duplex block for 6 multimode fibre optics	■	1
0321 24	LC duplex block for 12 multimode fibre optics	■	1
0321 25	LC duplex high density block for 24 multimode fibre optics	■	1
0321 34	Multimode 4 MTP <sup>1</sup> feedthrough adapter	■	1



0321 21

### Copper block for fibre optic drawer

0321 32	"It clips directly to the optic drawer to be equipped, Cat.No 0321 00 It gives the possibility of mixing fibre optic and copper"	■	1
---------	---	---	---

### Accessories for optic drawer to be equipped

#### Accessory for receipt of a fan-out

0321 28	It's clipped at the back of the drawer It enables the entry of preterminated Cat.Nos	■	1
---------	---	---	---

#### Blank

0321 29	Blank block	■	1
---------	-------------	---	---

#### Pigtail cassette

0321 30	Capacity 24 fibre optics	■	1
---------	--------------------------	---	---

#### Coiling kit

0321 31	1 accessory	■	1
---------	-------------	---	---

### Modular 19" panel to be equipped with cassettes

0321 40	Depth 190 mm, height 1 U	■	1
---------	--------------------------	---	---

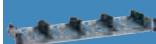

0321 40

\* MRP - Maximum Retail Price Inclusive of all taxes including GST.

■ Price available on request.

1: MTP is a registered trademark of US Conec Ltd

## Legrand cabling system LCS<sup>3</sup> fibre optic

Cat.Nos	Description	MRP* ₹ / Unit	Pack
---------	-------------	------------------	------

### Optic drawer cassettes

#### Fibre optic splice cassette

0321 41	It can accept all modular fibre optic blocks	■	1
---------	--	---	---



0321 41

#### Copper cassette to be equipped

0337 55	It can accept 6 cat. 5e, cat. 6 and cat. 6 <sub>A</sub> connectors	■	1
---------	--	---	---

#### MTP<sup>1</sup> preterminated cassette (MPO compatible)

Front and rear extraction  
High performance cassette, low insertion loss  
<0.35 dB

0321 42	Multimode OM4 cassette (50/125 µm) 24 filaments LC OM4 Type A/C	■	1
0321 43	Multimode OM4 cassette (50/125 µm) 12 SC OM4 Type A/C	■	1
0321 44	Single-mode OS2 cassette (9/125 µm) type OS2 24 LC OS2 Type A/C	■	1
0321 45	Single-mode OS2 cassette (9/125 µm) 12 SC OS2 Type A/C	■	1

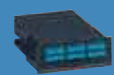

0321 43

#### Blanking cassette

0337 57	Used to blank the panel	■	1
---------	-------------------------	---	---

#### Adapters

0321 33	Single-mode 4 MTP <sup>1</sup> adapter (installation in cassette 0 321 41)	■	1
0321 34	Multi-mode 4 MTP <sup>1</sup> adapter (installation in cassette 0 321 41)	■	1

### Accessories for 19" panel to be equipped with cassettes

0321 46	Rear cable management accessory For installation on panels Cat.No 0 321 40	■	1
0321 47	Cord management kit (guide/support/door)	■	1



0321 46

### Pigtails

#### 50/125 µm - OM2 (PC)

##### Connectors

0322 10	SC 1 m LSZH	■	10
0322 11	LC 1 m LSZH	■	10
0322 12	ST 1 m LSZH	■	10
0322 13	SC 2 m LSZH	■	10
0322 14	LC 2 m LSZH	■	10
0322 15	ST 2 m LSZH	■	10

Bold Cat.Nos are products normally available with Legrand (India) Stockists. Cat.Nos that are not bold - delivery within 4 - 8 weeks from the date of order. Bold packing quantity is our mandatory packing. Orders to be placed by Legrand (India) Stockist in multiples of the same.

## Legrand cabling system LCS<sup>3</sup> fibre optic

Cat.Nos	Description	MRP* ₹ / Unit	Pack
---------	-------------	------------------	------

### 50/125 µm - OM3 (PC)

#### Connectors

0322 20	SC 1 m LSZH	■	10
0322 21	LC 1 m LSZH	■	10
0322 22	ST 1 m LSZH	■	10
0322 23	SC 2 m LSZH	■	10
0322 24	LC 2 m LSZH	■	10

### 50/125 µm - OM4 (PC)

#### Connectors

0322 30	SC 1 m LSZH	■	10
0322 31	LC 1 m LSZH	■	10
0322 32	ST 1 m LSZH	■	10
0322 33	SC 2 m LSZH	■	10
0322 34	LC 2 m LSZH	■	10

### 9/125 µm - OS2 (APC or UPC) - OS1 compatible

#### Connectors

0322 40	SC-APC OS2 1 m LSZH	■	10
0322 41	SC-UPC OS2 1 m LSZH	■	10
0322 42	LC-APC OS2 1 m LSZH	■	10
0322 43	LC-UPC OS2 1 m LSZH	■	10
0322 44	ST-UPC OS2 1 m LSZH	■	10
0322 45	SC-APC OS2 2 m LSZH	■	10
0322 46	SC-UPC OS2 2 m LSZH	■	10
0322 47	LC-UPC OS2 2 m LSZH	■	10
0322 48	LC-APC OS2 2 m LSZH	■	10
0322 49	ST-UPC OS2 2 m LSZH	■	10

### Set of 12 LC pigtails

0326 24	OS2 12 pigtails LC-UPC	■	1
0326 26	OM3 12 pigtails LC-PC	■	1
0326 71	OM4 12 pigtails LC-PC	■	1

### Pigtail sleeves

0327 44	40 mm - bag of 50 sheaths	■	1
---------	---------------------------	---	---

### Glue-on connectors 50/125 and 62.5/125 µm

0331 27	ST	■	10
0331 47	SC	■	10
0331 00	LC	■	10

### Fan-out units

0330 48	6 fibre optic fan-out unit	■	1
0330 49	12 fibre optic fan-out unit	■	1

\* MRP - Maximum Retail Price Inclusive of all taxes including GST.

■ Price available on request.

1: MTP is a registered trademark of US Conec Ltd

## Legrand cabling system LCS<sup>3</sup> fibre optic

Cat.Nos	Description	MRP* ₹ / Unit	Pack
---------	-------------	------------------	------

### Tool case for the preparation of the fibre optic for quick-connect connectors

0322 70	It contains the tools required for the preparation of the fibre optic cable, for the completion of a first test to confirm the correct connection of the fibre optic to the connector, and the accessories for easy connection in all situations	■	1
---------	--	---	---

### Quick-connect connectors

#### OM3/OM4 multimode connectors

Set of 12 connectors

0322 71	LC PC 50/125 µm, 900/250 µm	■	1
0322 72	SC PC 50/125 µm, 900/250 µm	■	1

#### OS2 single-mode connectors

Set of 12 connectors

0322 73	LC UPC 9/125 µm, 900/250 µm	■	1
0322 74	SC UPC 9/125 µm, 900/250 µm	■	1
0322 75	SC APC 9/125 µm, 900/250 µm	■	1

### Precision cleaver for the update of the case kit Cat.No 0326 90

0322 80	It's used in conjunction with the kit of the case Cat.No 0 326 90, to cut the fibre optic with precision, and fit the quick-connect connectors, Cat.No 0 322 71 to 0 322 75	■	1
---------	---	---	---

### Fibre optic cleaning accessories

0322 83	Ferrule cleaner MPO/MTP1	■	1
0322 81	Ferrule cleaner LC (PC/APC)	■	1
0322 82	Ferrule cleaner SC (PC/APC)	■	1
0322 84	LC replacement cartridge	■	1
0322 85	LC replacement cartridge	■	1

### Fibre optic drawers with front facing cord management

0321 50	1 U	■	1
0321 52	2 U	■	1
0321 53	4 U	■	1
0321 51	UHD Panel to be equipped cassette without rear management 1 U	■	1

### Very high density cassettes

#### Multimode OM4 cassette (50/125 µm)

For OM4 type 50/125 µm multimode installations

0321 54	MPO cassette 12 LC OM4 Type A/C	■	1
---------	---------------------------------	---	---

Bold Cat.Nos are products normally available with Legrand (India) Stockists. Cat.Nos that are not bold - delivery within 4 - 8 weeks from the date of order. Bold packing quantity is our mandatory packing. Orders to be placed by Legrand (India) Stockist in multiples of the same.

## Legrand cabling system LCS<sup>3</sup> fibre optic

Cat.Nos	Description	MRP* ₹ / Unit	Pack
---------	-------------	------------------	------

### OS2 cassette (9/125 µm)

For OS2 type 9/125 µm multimode installations

0321 55	MPO cassette 12 LC OS2 Type A/C	■	1
---------	---------------------------------	---	---

### MTP<sup>1</sup> adapters (MPO compatible)

They are clipped directly to the fibre optic drawers, Cat.Nos 0 321 50/51/52/53

0321 56	Multimode 4 MTP1 adapter	■	1
0321 57	Single-mode 4 MTP1 adapter	■	1

### LC adapter

It's clipped directly to the fibre optic drawers, Cat.Nos 0 321 50/51/52/53

0321 58	Adapter 12 LC multimode	■	1
---------	-------------------------	---	---

### Modular 19" panel to be equipped with cassettes

0321 40	Depth 190 mm, height 1 U	■	1
---------	--------------------------	---	---

### High density MTP1 cassette (MPO compatible)

#### Fibre optic splice cassette

0321 41	It can accept all modular fibre optic blocks	■	1
---------	--	---	---

### Copper cassette to be equipped

0337 55	It can accept 6 cat. 5e, cat. 6 and cat. 6A connectors	■	1
---------	--	---	---

### Multimode OM4 cassettes (50/125 µm)

0321 42	MTP <sup>1</sup> cassette (MPO compatible) 24 LC OM4 Type A/C	■	1
0321 43	MTP <sup>1</sup> cassette (MPO compatible) 12 SC OM4 Type A/C	■	1

### Single-mode OS2 cassettes (9/125 µm)

OS2 type

0321 44	MTP <sup>1</sup> cassette (MPO compatible) 24 LC OS2 Type A/C	■	1
0321 45	MTP <sup>1</sup> cassette (MPO compatible) 12 SC OS2 Type A/C	■	1

### Blanking cassette

0337 57	Used to blank the panel	■	1
---------	-------------------------	---	---

### MTP<sup>1</sup> adapters

It's installed in splice cassettes, Cat.No 0 321 41  
It enables MTP<sup>1</sup>/MTP<sup>1</sup> feedthrough

0321 33	Single-mode 4 MTP <sup>1</sup> adapter	■	1
0321 34	Multimode 4 MTP <sup>1</sup> adapter	■	1

\* MRP - Maximum Retail Price Inclusive of all taxes including GST.

■ Price available on request.

1: MTP is a registered trademark of US Conec Ltd

## Legrand cabling system LCS<sup>3</sup> fibre optic preterminated solution

Cat.Nos	Description	MRP* ₹ / Unit	Pack
---------	-------------	------------------	------

### Accessories for 19" panel to be equipped with cassette

0321 46	Rear cable management accessory For installation on panels Cat.No 0 321 40	■	1
0321 47	Cord management kit (guide/support/door)	■	1

### High density preterminated fibre optic links

#### Micro cables OM3 Fan-out - Fan-out

Micro cables with spark gap, output 2 mm

0324 01	6 LC Duplex - 6 LC Duplex Length 10	■	1
0324 02	6 LC Duplex - 6 LC Duplex Length 20 (m)	■	1
0324 03	6 LC Duplex - 6 LC Duplex Length 30 (m)	■	1
0324 04	6 LC Duplex - 6 LC Duplex Length 40 (m)	■	1
0324 05	6 LC Duplex - 6 LC Duplex Length 50 (m)	■	1
0324 11	12 LC Duplex - 12 LC Duplex Length 10 (m)	■	1
0324 12	12 LC Duplex - 12 LC Duplex Length 20 (m)	■	1
0324 13	12 LC Duplex - 12 LC Duplex Length 30 (m)	■	1
0324 14	12 LC Duplex - 12 LC Duplex Length 40 (m)	■	1
0324 15	12 LC Duplex - 12 LC Duplex Length 50 (m)	■	1

#### Micro cables OS2 Fan-out - Fan-out

Micro cables with spark gap, output 2 mm

0324 21	6 LC Duplex - 6 LC Duplex Length 10 (m)	■	1
0324 22	6 LC Duplex - 6 LC Duplex Length 20 (m)	■	1
0324 23	6 LC Duplex - 6 LC Duplex Length 30 (m)	■	1
0324 24	6 LC Duplex - 6 LC Duplex Length 40 (m)	■	1
0324 25	6 LC Duplex - 6 LC Duplex Length 50 (m)	■	1
0324 31	12 LC Duplex - 12 LC Duplex Length 10 (m)	■	1
0324 32	12 LC Duplex - 12 LC Duplex Length 20 (m)	■	1
0324 33	12 LC Duplex - 12 LC Duplex Length 30 (m)	■	1
0324 34	12 LC Duplex - 12 LC Duplex Length 40 (m)	■	1
0324 35	12 LC Duplex - 12 LC Duplex Length 50 (m)	■	1

Bold Cat.Nos are products normally available with Legrand (India) Stockists. Cat.Nos that are not bold - delivery within 4 - 8 weeks from the date of order. Bold packing quantity is our mandatory packing. Orders to be placed by Legrand (India) Stockist in multiples of the same.



## Legrand cabling system LCS<sup>3</sup> cables

Cat.Nos	Description	MRP* ₹ / Unit	Pack
---------	-------------	------------------	------

### Micro cables OM3 MTP1

0324 41	12 fibre optics - MTP <sup>1</sup> -MTP <sup>1</sup> Length 10 (m)	■	1
0324 42	12 fibre optics - MTP <sup>1</sup> -MTP <sup>1</sup> Length 20 (m)	■	1
0324 43	12 fibre optics - MTP <sup>1</sup> -MTP <sup>1</sup> Length 30 (m)	■	1
0324 44	12 fibre optics - MTP <sup>1</sup> -MTP <sup>1</sup> Length 40 (m)	■	1
0324 45	12 fibre optics - MTP <sup>1</sup> -MTP <sup>1</sup> Length 50 (m)	■	1

### Micro cables OS2 MTP1

0324 51	12 fibre optics - MTP <sup>1</sup> -MTP <sup>1</sup> Length 10 (m)	■	1
0324 52	12 fibre optics - MTP <sup>1</sup> -MTP <sup>1</sup> Length 20 (m)	■	1
0324 53	12 fibre optics - MTP <sup>1</sup> -MTP <sup>1</sup> Length 30 (m)	■	1
0324 54	12 fibre optics - MTP <sup>1</sup> -MTP <sup>1</sup> Length 40 (m)	■	1
0324 55	12 fibre optics - MTP <sup>1</sup> -MTP <sup>1</sup> Length 50 (m)	■	1

### OM 4 multimode fibre optic cables (50/125 µm)

"Bend insensitive"

For multimode installations 50/125 µm, type OM 4

Aqua sheaths

Suitable for 10 Giga Ethernet networks

#### Loose tube

0325 43	Indoor/outdoor (glass strands) 4 fibres - 2000 m	■	2000
0325 44	Indoor/outdoor (glass strands) 8 fibres - 2000 m	■	2000
0325 45	Indoor/outdoor (glass strands) 12 fibres - 2000 m	■	2000
0325 46	Outdoor, corrugated steel tape 4 fibres - 2000 m	■	2000
0325 47	Outdoor, corrugated steel tape 8 fibres - 2000 m	■	2000
0325 48	Outdoor, corrugated steel tape 12 fibres - 2000 m	■	2000

#### Tight structure 900 µm

0326 65	Indoor/outdoor (glass strands) 6 fibres - 500 m	■	2000
0326 66	Indoor/outdoor (glass strands) 6 fibres - 1000 m	■	2000
0326 67	Indoor/outdoor (glass strands) 12 fibres - 1000 m	■	2000
0326 68	Indoor/outdoor (glass strands) 24 fibres - 1000 m	■	2000

### OS 2 single-mode fibre optic cables (9/125 µm) - (OS1 compatible)

For single-mode installations 9/125 µm,

type OS 2

Yellow or black sheaths for outdoor,  
rodent guard...

#### Loose tube

0325 02	Indoor/outdoor (glass strands) 4 fibres	■	2000
0325 03	Indoor/outdoor (glass strands) 8 fibres	■	2000
0325 23	Outdoor, corrugated steel tape 4 fibres	■	2000

\* MRP - Maximum Retail Price Inclusive of all taxes including GST.

■ Price available on request.

1: MTP is a registered trademark of US Conec Ltd

## Legrand cabling system LCS<sup>3</sup> cables

Cat.Nos	Description	MRP* ₹ / Unit	Pack
---------	-------------	------------------	------

### Loose tube

0325 24	Outdoor, corrugated steel tape 8 fibres	■	2000
0325 25	Outdoor, corrugated steel tape 24 fibres	■	2000
0325 12	Indoor/outdoor (glass strands) 6 fibres	■	2000
0325 13	Outdoor, corrugated steel tape 6 fibres	■	2000
0325 14	Indoor/outdoor (glass strands) 12 fibres	■	2000
0325 15	Outdoor, corrugated steel tape 12 fibres	■	2000
0325 51	Indoor/outdoor (glass strands) 24 fibres	■	2000

### Tight structure 900 µm

0325 50	Indoor/outdoor (glass strands) 12 fibres	■	2000
---------	---	---	------

### OM 3 multimode fibre optic cables (50/125 µm)

"Bend insensitive"

For multimode installations 50/125 µm, type OM 3

Aqua sheaths

Suitable for 10 Giga Ethernet networks

#### Loose tube

0325 53	Indoor/outdoor (glass strands) 24 fibres	■	2000
0325 37	Indoor/outdoor (glass strands) 4 fibres	■	2000
0325 38	Indoor/outdoor (glass strands) 8 fibres	■	2000
0325 39	Indoor/outdoor (glass strands) 12 fibres	■	2000
0325 40	Outdoor, corrugated steel tape 8 fibres	■	2000
0325 41	Outdoor, corrugated steel tape 12 fibres	■	2000
0325 42	Outdoor, corrugated steel tape 24 fibres	■	2000

#### Tight structure 900 µm

0325 10	Indoor/outdoor (glass strands) 6 fibres	■	2000
0325 11	Indoor/outdoor (glass strands) 12 fibres	■	2000
0325 52	Indoor/outdoor (glass strands) 24 fibres	■	2000

### OM 2 multimode fibre optic cables (50/125 µm)

For 50/125 µm multimode installations (OM 2)

Orange jacket or black for outdoor, corrugated

#### Loose tube

0325 04	Indoor/outdoor (universal) 6 fibres	■	2000
0325 05	Outdoor, corrugated steel tape 6 fibres	■	2000
0325 06	Indoor/outdoor (universal) 12 fibres	■	2000
0325 07	Outdoor, corrugated steel tape 12 fibres	■	2000

Bold Cat.Nos are products normally available with Legrand (India) Stockists. Cat.Nos that are not bold - delivery within 4 - 8 weeks from the date of order. Bold packing quantity is our mandatory packing. Orders to be placed by Legrand (India) Stockist in multiples of the same.

## Legrand cabling system LCS<sup>3</sup> fibre optic

Cat.Nos	Description	MRP* ₹ / Unit	Pack
<b>900 µm Tight buffer</b>			
0325 55	Indoor/outdoor (universal) 4 fibres	■	2000
0325 08	Indoor/outdoor (universal) 6 fibres	■	2000
0325 09	Indoor/outdoor (universal) 12 fibres	■	2000

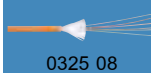

0325 08

## Legrand cabling system LCS<sup>3</sup> patch cords

### OS 1/OS 2 (UPC) single-mode optical cords

#### SC/SC duplex cords

0326 00	Length: 1 m	■	3
0326 01	Length: 2 m	■	3
0326 02	Length: 3 m	■	3

#### SC/LC duplex cords

0326 03	Length: 1 m	■	3
0326 04	Length: 2 m	■	3
0326 05	Length: 3 m	■	3

#### LC/LC duplex cords

0326 28	Length: 0.5 m	■	3
0326 06	Length: 1 m	■	3
0326 07	Length: 2 m	■	3
0326 08	Length: 3 m	■	3
0326 29	Length: 5 m	■	3



0326 07

#### LC/LC Uniboot duplex cords

Reversible polarity

0326 86	Length: 1 m	■	3
0326 87	Length: 2 m	■	3
0326 88	Length: 3 m	■	3
0326 89	Length: 5 m	■	3
0326 92	Length: 10 m	■	3

### OM 4 multimode fibre optic cords (50/125 µm)

#### SC/SC duplex cords

0326 30	Length: 1 m	■	3
0326 31	Length: 2 m	■	3
0326 32	Length: 3 m	■	3

#### LC/LC duplex cords

0326 33	Length: 0.5 m	■	3
0326 34	Length: 1 m	■	3
0326 35	Length: 2 m	■	3
0326 36	Length: 3 m	■	3
0326 37	Length: 5 m	■	3

#### LC/LC Uniboot duplex cords

Reversible polarity

0326 95	Length: 1 m	■	3
0326 96	Length: 2 m	■	3
0326 97	Length: 3 m	■	3
0326 98	Length: 5 m	■	3
0326 99	Length: 10 m	■	3

\* MRP - Maximum Retail Price Inclusive of all taxes including GST.

■ Price available on request.

1: MTP is a registered trademark of US Conec Ltd

## Legrand cabling system LCS<sup>3</sup> fibre optic preterminated solution

Cat.Nos	Description	MRP* ₹ / Unit	Pack
<b>OM 3 multimode fibre optic cords (50/125 µm)</b>			
<b>SC/SC duplex cords</b>			
0326 09	Length: 1 m	■	3
0326 10	Length: 2 m	■	3
0326 11	Length: 3 m	■	3



0326 13

#### SC/LC duplex cords

0326 12	Length: 1 m	■	3
0326 13	Length: 2 m	■	3
0326 14	Length: 3 m	■	3

#### LC/LC duplex cords

0326 15	Length: 1 m	■	3
0326 16	Length: 2 m	■	3
0326 17	Length: 3 m	■	3

### OM 2 multimode fibre optic cords (50/125 µm)

#### ST/ST duplex cords

0330 80	Length: 1 m	■	3
0330 81	Length: 2 m	■	3
0330 82	Length: 3 m	■	3

#### SC/SC duplex cords

0330 69	Length: 1 m	■	3
0330 70	Length: 2 m	■	3
0330 71	Length: 3 m	■	3

#### ST/SC duplex cords

0330 72	Length: 2 m	■	3
0330 73	Length: 3 m	■	3

#### LC/LC duplex cords

0330 61	Length: 2 m	■	3
---------	-------------	---	---

#### SC/LC duplex cords

0330 75	Length: 1 m	■	3
0330 63	Length: 2 m	■	3
0330 76	Length: 3 m	■	3

#### LC/ST duplex cords

0330 65	Length: 2 m	■	3
---------	-------------	---	---

### Fibre optic feedthrough sockets

#### 2 x ST fibre optic feedthrough socket

Bayonet mount (STII compatible)

0786 16	White	■	1
---------	-------	---	---

#### 2 x SC fibre optic feedthrough socket

"Push-pull" connection

0786 17	White	■	1
---------	-------	---	---

#### 2 x LC fibre optic feedthrough socket

"Push-pull" connection

0786 18	White	■	1
---------	-------	---	---

Bold Cat.Nos are products normally available with Legrand (India) Stockists. Cat.Nos that are not bold - delivery within 4 - 8 weeks from the date of order. Bold packing quantity is our mandatory packing. Orders to be placed by Legrand (India) Stockist in multiples of the same.

# LIGHTING MANAGEMENT SOLUTIONS

INTRODUCING SMART RANGE OF STANDALONE SENSORS TO PUT A STOP TO ENERGY WASTE



048953  
PIR miniature



048955  
Microwave



048806  
Dual Technology

## FEATURES



Dali Dimming  
with on/off



Configuration  
By App



Adjustable  
Time delay



Day Light  
harvesting



Occupancy/ Vacancy



Sensitivity  
adjustment



Scan to know more about  
the product.

## Movement detectors

Cat.Nos	Description	MRP* ₹ / Unit	Pack
---------	-------------	------------------	------

### Movement detectors for lighting control

IP 20-IP 55 movement detector with 180- 360° detection angle. For 2000 Watt incandescent, 230 V halogen," 1000 VA fluorescent



0488 06

0488 99	PIR ceiling detector sensor	5168	1/10
0488 06	Dual ceiling switch sensor 8.5A	11072	1/10
0488 07	PIR ceiling switch sensor 10A	11164	1/10
0488 17	Pir switch sensor corridor	12522	1/10
0488 04	PIR switch sensor 2 outputs	12746	1/10
0489 33	PIR wall mounted sensor 270D	23998	1/10
0489 32	PIR ceiling mounted for warehouse	21658	1/10
0489 53	PIR ceiling mounted with DALI Dimming	16744	1/10
0489 54	PIR ceiling mounted	15142	1/10
0489 55	Microwave ceiling mounted with DALI dimming	18280	1/10
0489 59	PIR High bay sensor	23340	1/10
0488 75	Surface mount box	878	1/10
0882 40	Configuration gateway	25124	1/10



0489 53



0489 55

## Video door entry systems

Cat.Nos	Description	MRP* ₹ / Unit	Pack
---------	-------------	------------------	------

### Colour image digital video door entry system kit



3695 80



3695 70



3695 60



3695 50

3695 80	Basic video kit 7" hands free	16550	1
3695 70	Basic video kit 7" handset	17498	1
3695 60	Basic video kit 4.3" hands free	15184	1
3695 50	Basic video kit 4.3" handset	16224	1
3695 00	Basic audio kit handset	8420	1
3695 85	Basic video additional IU 7" hands free	9694	1
3695 75	Basic video additional IU 7" handset	11020	1
3695 65	Basic video additional IU 4.3" hands free	8712	1
3695 55	Basic video additional IU 4.3" handset	9710	1
3695 05	Basic audio additional handset	4810	1
3695 96	Basic additional video EP	6914	1
3695 95	Basic additional audio EP	4062	1
3695 97	Basic EP angle bracket	878	1

\* MRP - Maximum Retail Price Inclusive of all taxes including GST.  
Red Cat.Nos - new products

Bold Cat.Nos are products normally available with Legrand (India) Stockists. Cat.Nos that are not bold - delivery within 4 - 8 weeks from the date of order. Bold packing quantity is our mandatory packing. Orders to be placed by Legrand (India) Stockist in multiples of the same.



# D45 SYSTEM

## HIGH PERFORMANCE SIMPLIFIED

The D45 system simplifies installation in residential spaces right from a single house to a group of houses to residential complexes with a large number of apartments.



Audio handset



Entrance panels



10" Touch screen internal unit



Slim 7" wide screen with alarm function



Scan to know more about the product.

# CLASSE 300

OPEN YOUR DOOR FROM  
ANYWHERE  
STAY CONNECTED WITH THE CLASSE 300

## WELCOME YOUR VISITORS WITH YOUR SMARTPHONE!

Connected and user-friendly, whether you are in or out of your house the new Classe 300 Door entry kit enables you to see on your smartphone who rings at your door, to talk to visitors, to open the door for them...

## SIMPLE TO INSTALL

No specific cabling, no additional interface or complex setting... The installation follows the same rules as classic-2 wire system!

## EASY TO CONNECT

Nothing easier than combining the Classe 300 with a smartphone

- Connection of the internal unit to the local Wi-Fi Network
- Installation of the Door Entry app ( Available for free on App Store and Google Playstore) on Smartphone
- Creation of a Legrand user account
- Association of the smartphone with the new door entry system



Scan to know more about  
the product.

# P17 TEMPRA PRO

ALWAYS ENSURING  
CONTINUITY OF SERVICE

By updating its IP44 and IP 66/67 range of industrial sockets, Legrand is meeting the expectations of professional users. New benefits in terms of safety, implementation, design & ergonomics guarantee the longevity of this family of products, which has already proven itself over time.



## IP44

SOCKETS FOR INTERNAL AND EXTERNAL USE, PROTECTED AGAINST PROJECTIONS OF WATER (BUT NOT EXPOSED TO DIRECT JETS)



Straight plugs



Mobile sockets



Panel mounting sockets

A TRANSFORMED RANGE  
WHICH HARMONISES WITH  
THE LEGRAND INDUSTRIAL  
SOCKETS RANGE

- From 16 to 32 A
- 2 P+ E / 3 P+E / 3 P+N+E
- From 100 to 500 VA
- 50/60 Hz
- Screw connection



Scan to know more about  
the product.





AIRPORTS, DATA CENTRES,  
HOTELS, ETC. P17 TEMPRA  
PRO IS IDEAL FOR ALL MAJOR  
PROJECTS

# IP66/67/69\*

WEATHERPROOF SOCKETS THAT  
CAN WITHSTAND TEMPORARY  
IMMERSION (RAIN, FLOODS, ETC)



Surface mounting  
sockets



Straight plugs

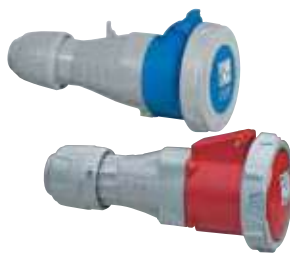

Mobile sockets



Panel mounting  
sockets



Surface mounting  
sockets

- From 16 to 125 A
- 2 P+ E / 3 P+E / 3 P+N+E
- From 100 to 500 VA
- 50/60 Hz
- Screw connection

\* On 63 and 125 A plugs and mobile sockets

# P17 TEMPRA PRO

## ENSURING EASE OF USE AND SAFETY

The new P17 Tempra Pro range has been subject to extensive research in terms of design and safety in order to make life safer and easier for the user. Good product gripping, compact dimensions for use in tight spaces, easier handling, etc. Compliance with standards, anti-corrosion treated materials and components, etc. A comprehensive set of solutions which comply with the standards.

AN INNOVATIVE DESIGN THAT COMPLIES WITH STANDARDS IEC 60309-1 AND 2 AND RESPECTS THE ENVIRONMENT

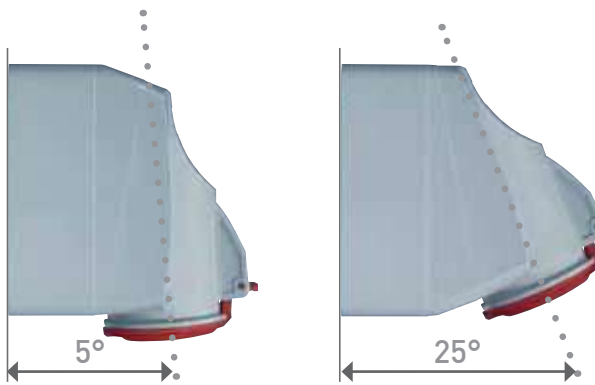

### 1 2 MOUNTING POSITIONS

To solve the problem of limited space, the surface mounting sockets offer 2 different mounting positions (5° or 25°) which allow users to adapt to the space available without changing the box.



### 2 CABLE GRIP

Captive cable grip with anti-vibration system holds the cable in place permanently. The 63 and 125 A products are also equipped with a locking screw.



### 3 EASE OF HANDLING

Gripping areas on the body of the mobile products and the cable grip.



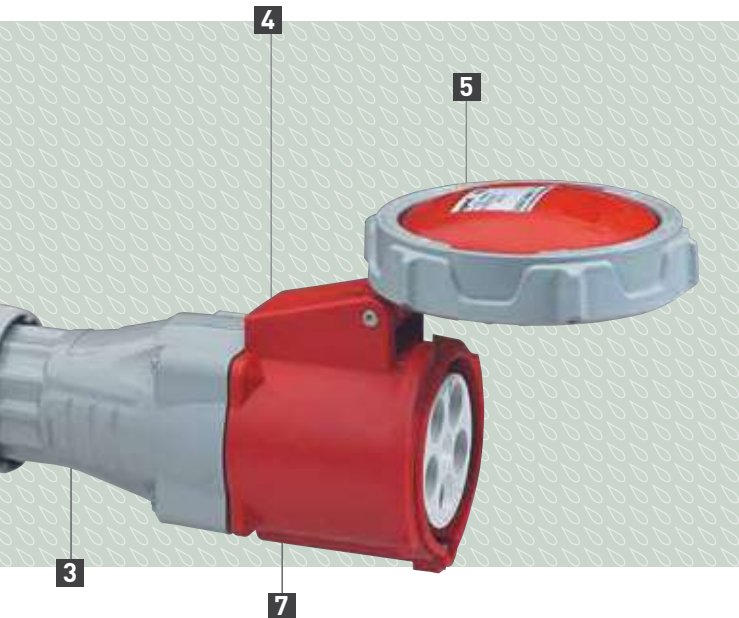

## SAFETY & THE ENVIRONMENT

### SAFETY

Connection terminals compliant with standards IEC 60 309 1 & 2

Production sites certified according to ISO 14001 and ISO 9001

Very high resistance to chemical products. Plugs and sockets made of polyamide 6

Anti-corrosion treated screws, stainless steel springs for the socket covers

Resistant to temperatures of -25°C to +40°C

### ENVIRONMENT

Halogen-free recyclable materials (silicone, PVC) for IP 44 products

Grouped packaging in boxes

PEP products (Eco Passport)



#### 4 OPENING LEVER

For easier connection / disconnection. Cover held open on panel sockets and surface mounting sockets.



#### 5 POSITION MARKING

Information engraved on the ring cover of IP66/67 products means the user can check quickly whether it is in the open or closed position. Marking on cover and flap for easy identification.



#### 6 RIVETED METAL SHAFT

For 63 and 125 A products the riveted metal shaft ensures more strength. The notched locking ring facilitates the locking / unlocking operations.



#### 7 WEATHERPROOF SEALING

For panel mounting sockets.

## P17 Tempra Pro IP 44 - LV 16 and 32 A - sockets and plugs

Cat.Nos	Description	MRP* ₹ / Unit	Pack
---------	-------------	------------------	------

### Surface mounting sockets

5551 54	200/250 V~, 16 A 2P+E	742	10
5551 58	380/415 V~, 16 A 3P+E	916	10
5551 59	380/415 V~, 16 A 3P+N+E	970	10
5552 54	200/250 V~, 32 A 2P+E	928	5
5552 58	380/415 V~, 32 A 3P+E	1162	10
5552 59	380/415 V~, 32 A 3P+N+E	1230	10

### Panel mounting sockets inclined outlet

5551 84	200/250 V~, 16 A 2P+E	460	10
5551 88	380/415 V~, 16 A 3P+E	678	10
5551 89	380/415 V~, 16 A 3P+N+E	714	10
5552 84	200/250 V~, 32 A 2P+E	708	10
5552 88	380/415 V~, 32 A 3P+E	896	10
5552 89	380/415 V~, 32 A 3P+N+E	950	10

### Mobile sockets

5551 04	200/250 V~, 16 A 2P+E	600	10
5551 08	380/415 V~, 16 A 3P+E	668	10
5551 09	380/415 V~, 16 A 3P+N+E	708	10
5552 14	200/250 V~, 32 A 2P+E	794	10
5552 18	380/415 V~, 32 A 3P+E	954	10
5552 19	380/415 V~, 32 A 3P+N+E	1010	10

### Straight plugs

5551 24	200/250 V~, 16 A 2P+E	424	10
5551 28	380/415 V~, 16 A 3P+E	520	10
5551 29	380/415 V~, 16 A 3P+N+E	548	10
5552 34	200/250 V~, 32 A 2P+E	640	10
5552 38	380/415 V~, 32 A 3P+E	732	10
5552 39	380/415 V~, 32 A 3P+N+E	776	10

## P17 Tempra - domestic pin configuration 16 A - 250 VA

### Flush-mounting boxes

0577 21	For 2 panel mounting sockets With single fixing centres 70 x 70 mm - 16 A	4244	3
0577 22	For 1 panel mounting socket With single fixing centres 70 x 70 mm - 16 or 32 A (32 A to be fixed horizontally)	2546	3

\* MRP - Maximum Retail Price Inclusive of all taxes including GST.

## P17 Tempra Pro IP 66/67 LV 16 and 32 A

Cat.Nos	Polarity	MRP* ₹ / Unit	Pack
---------	----------	------------------	------

### Surface mounting sockets

5553 54	200/250 V~, 16 A 2P+E	1242	5
5553 58	380/415 V~, 16 A 3P+E	1382	5
5553 59	380/415 V~, 16 A 3P+N+E	1502	5
5554 54	200/250 V~, 32 A 2P+E	1472	5
5554 55	200/250 V~, 32 A 3P+E	2542	5
5554 59	380/415 V~, 32 A 3P+N+E	2756	5

### Panel mounting sockets

5553 84	200/250 V~, 16 A 2P+E	908	5
5553 88	380/415 V~, 16 A 3P+E	966	5
5553 89	380/415 V~, 16 A 3P+N+E	1026	5
5554 84	200/250 V~, 32 A 2P+E	1154	5
5554 88	380/415 V~, 32 A 3P+E	1322	5
5554 89	380/415 V~, 32 A 3P+N+E	1402	5

### Mobile sockets

5553 04	200/250 V~, 16 A 2P+E	1112	5
5553 08	380/415 V~, 16 A 3P+E	1382	5
5553 09	380/415 V~, 16 A 3P+N+E	1466	5
5554 14	200/250 V~, 32 A 2P+E	1526	5
5554 18	380/415 V~, 32 A 3P+E	1630	5
5554 19	380/415 V~, 32 A 3P+N+E	1732	5

### Straight plugs

5553 24	200/250 V~, 16 A 2P+E	966	5
5553 28	380/415 V~, 16 A 3P+E	1060	5
5553 29	380/415 V~, 16 A 3P+N+E	1126	5
5554 34	200/250 V~, 32 A 2P+E	1308	5
5554 38	380/415 V~, 32 A 3P+E	1376	5
5554 39	380/415 V~, 32 A 3P+N+E	1458	5

## P17 Tempra Pro IP 66/67 LV 32 A for refrigerated containers

### Combined unit, plug and mobile socket for refrigerated containers

6571 06	Combined unit with interlocked switched socket - Double mechanical interlock - Cable glands are not supplied	19616	1
---------	--	-------	---

Bold Cat.Nos are products normally available with Legrand (India) Stockists. Cat.Nos that are not bold - delivery within 4 - 8 weeks from the date of order. Bold packing quantity is our mandatory packing. Orders to be placed by Legrand (India) Stockist in multiples of the same.



## P17 Tempra Pro IP 66/67 LV 32 A for refrigerated containers

Cat.Nos	Polarity	MRP* ₹ / Unit	Pack
---------	----------	------------------	------

### Combined unit, plug and mobile socket for refrigerated containers

5554 91	Panel mounting socket	■	5
5554 21	Mobile socket with cable grip Ø12 to 21.5 mm	■	5
5554 41	Straight plug With cable grip Ø12 to 21.5 mm		5

## P17 Tempra Pro IP 66/67 - LV 63 and 125 A

### Surface mounting sockets

5555 54	200/250 V~, 63 A 2P+E	5136	2
5555 58	380/415 V~, 63 A 3P+E	5366	2
5555 59	380/415 V~, 63 A 3P+N+E	5670	2
5556 58	380/415 V~, 125 A 3P+E	14878	2
5556 59	380/415 V~, 125 A 3P+N+E	15770	2

### Panel mounting sockets

5555 84	200/250 V~, 63 A 2P+E	4072	2
5555 88	380/415 V~, 63 A 3P+E	4154	2
5555 89	380/415 V~, 63 A 3P+N+E	4376	2
5556 88	380/415 V~, 125 A 3P+E	11758	1
5556 89	380/415 V~, 125 A 3P+N+E	12572	1

### Straight plugs

5555 24	200/250 V~, 63 A 2P+E	3450	2
5555 28	380/415 V~, 63 A 3P+E	3502	2
5555 29	380/415 V~, 63 A 3P+N+E	3840	2
5556 28	380/415 V~, 125 A 3P+E	10430	1
5556 29	380/415 V~, 125 A 3P+N+E	11056	1

### Mobile sockets

5555 04	200/250 V~, 63 A 2P+E	4402	2
5555 08	380/415 V~, 63 A 3P+E	4570	2
5555 09	380/415 V~, 63 A 3P+N+E	4852	2
5556 08	380/415 V~, 125 A 3P+E	15182	1
5556 09	380/415 V~, 125 A 3P+N+E	16092	1

## Plugs and sockets

Cat.Nos	Polarity	MRP* ₹ / Unit	Pack
---------	----------	------------------	------

### P17 combined unit to be equipped

#### Bases with mechanical super-compact sockets

0573 00	16 A, 2P+E IP 44 Interlock	5186	1
0573 02	16 A, 3P+N+E IP 44 Interlock	5724	1
0573 20	16 A, 2P+E IP 55 Interlock	5818	1
0573 22	16 A, 3P+N+E IP 55 Interlock	6546	1
0577 23	Mounting plate for 2 super-compact mechanical interlock sockets	2912	1

#### Bases for 125 x 220 mm face plates

#### Example of combined unit configuration

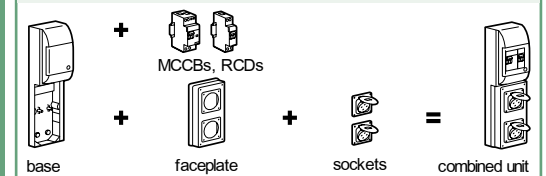

0577 10	Surface mounting box - upto 2 sockets	1214	2
0589 38	Surface mounting box with 5 module dinrail - upto 2 sockets	3390	1
0577 05	Surface mounting box with 12 module dinrail - upto 4 sockets	7488	1
0577 06	Surface mounting box with 18 module dinrail - upto 6 sockets	10482	1

#### Face plates 125 x 220 mm without sockets

0577 12	For 1 x 16 A or 32 - upto A socket	1150	5
0577 13	For 2 x 16 A - upto sockets	1444	5
0577 17	For 1 x 63 A - upto sockets	1326	5
0577 15	Blanking Plate	976	5

#### Bases for 125 x 280 mm faceplates

0577 11	Surface mounting box - upto 3 sockets	1262	3
0577 20	Surface mounting box with 5 module dinrail - upto 3 sockets	3636	1
0577 03	Surface mounting box with 12 module dinrail - upto 6 sockets	7762	1
0577 04	Surface mounting box with 18 module dinrail - upto 9 sockets	10798	1

\* MRP - Maximum Retail Price Inclusive of all taxes including GST.

Bold Cat.Nos are products normally available with Legrand (India) Stockists. Cat.Nos that are not bold - delivery within 4 - 8 weeks from the date of order. Bold packing quantity is our mandatory packing. Orders to be placed by Legrand (India) Stockist in multiples of the same.

## Plugs and sockets

Cat.Nos	Polarity	MRP* ₹ / Unit	Pack
---------	----------	------------------	------

### Face plates 125 x 280 mm without sockets

0577 18	For 2 x 16 A and / or 32 A sockets	1806	4
0577 19	For 1 x 16 A or 32 A socket and 1 x 63 A socket	1698	2
0577 14	For 3 x 16 A sockets	2058	4
0577 16	Blanking plate	1146	4

## Hypra industrial plugs and sockets

### Sockets

#### Prisinter panel mounting sockets - IP 44, IK 09

0520 02	230 V, 16 A, 2P+E	10558	1/10
0527 02	230 V, 32 A, 2P+E	11404	1/6
0529 03	415 V, 32 A, 3P+E	11744	1/6
0529 04	415 V, 32 A, 3P+N+E	13954	1/6
0536 04	415 V, 63 A, 3P+N+E	44506	1

#### Panel mounting sockets - inclined IP 44, IK 09

0522 23	415 V, 16 A, 3P+E	1708	5/50
0538 23	415 V, 63 A, 3P+E	5656	1

#### Mobile sockets - IP 44, IK 09

0522 83	415 V, 16 A, 3P+E	4106	5/50
---------	-------------------	------	------

### Plugs

#### Straight plugs - IP 44, IK 09

0520 42	250 V, 16 A, 2P+E	1856	5/50
0527 42	250 V, 32 A, 2P+E	2290	1/5
0522 43	415 V, 16 A, 3P+E	3024	5/50
0529 43	415 V, 32 A, 3P+E	3062	5/50
0529 44	415 V, 32 A, 3P+N+E	3390	5/15
0538 43	415 V, 63 A, 3P+E	8092	1/5
0538 44	415 V, 63 A, 3P+N+E	10872	1/5

## Metra plugs and sockets

### Plugs

#### Ivory

6500 22	240 V, 10 A, 2P+E	204	1/5/100
6500 28	240 V, 20 A, 2P+E	216	1/5/100

#### Grey

6500 02	240 V, 10 A, 2P+E	204	1/5/100
6500 08	240 V, 20 A, 2P+E	216	1/5/100
6500 10	440 V, 20 A, 3P+E	286	1/5/100
6500 16	440 V, 32 A, 3P+E	536	1/5/100

### Sockets

6500 03	240 V, 10 A, 2P+E With blue cap	208	1/5/100
6500 23	240 V, 10 A, 2P+E With ivory cap	208	1/5/100

## Hypra industrial plugs and sockets

Cat.Nos	Description	MRP* ₹ / Unit	Pack
---------	-------------	------------------	------

### Sockets

6500 09	240 V, 20 A, 2P+E With blue cap	236	1/5/100
6500 29	240 V, 20 A, 2P+E With ivory cap	236	1/5/100
6500 11	440 V, 20 A, 3P+E With red cap	318	1/5/100
6500 17	440 V, 32 A, 3P+E With red cap	536	1/5/100

## Plugs and sockets

### P17 tempra combined units

#### With interlocked switched sockets and surface mounting box IP 44

0566 01	250 V, 16 A, 2P+E	7788	1
0566 09	250 V, 32 A, 2P+E	9292	1
0566 13	415 V, 32 A, 3P+E	11238	1
0566 14	415 V, 32 A, 3P+N+E	11798	1

#### With interlocked switched sockets and surface mounting box IP 55

0566 21	250 V, 16 A, 2P+E	8652	1
0566 29	250 V, 32 A, 2P+E	9884	1
0566 33	415 V, 32 A, 3P+E	12530	1
0566 34	415 V, 32 A, 3P+N+E	12758	1

#### With interlocked switched sockets and surface mounting box IP 44 with DIN rail for 5 module DX<sup>3</sup> protection

0566 41	250 V, 16 A, 2P+E	8308	1
0566 49	250 V, 32 A, 2P+E	10106	1
0566 53	415 V, 32 A, 3P+E	11176	1
0566 54	415 V, 32 A, 3P+N+E	11958	1

#### With interlocked switched sockets and surface mounting box IP 66 with DIN rail for 5 module DX<sup>3</sup> protection

0566 61	250 V, 16 A, 2P+E	9308	1
0566 69	250 V, 32 A, 2P+E	10800	1
0566 73	415 V, 32 A, 3P+E	11660	1
0566 74	415 V, 32 A, 3P+N+E	12604	1

#### With interlocked switched sockets and without surface mounting box IP 55

0572 21	250 V, 16 A, 2P+E	7488	1
0572 29	250 V, 32 A, 2P+E	8466	1
0572 33	415 V, 32 A, 3P+E	10054	1
0572 34	415 V, 32 A, 3P+N+E	10980	1
0572 95	415 V, 63 A, 3P+N+E, IP 66	23964	1
0577 00	Base box for 0572 95	4276	1

### P17 tempra combined units

#### with interlocked switched sockets IP 66

0589 18	380 to 415 V, 50/60 Hz, 63 A, 3P + E with provision for 5 module DX <sup>3</sup> protection	25520	1
0572 99	380 to 415 V, 50/60 Hz, 63 A, 3P+N+E with provision for 5 module DX <sup>3</sup> protection	28758	1



0529 03



0522 23



0522 83



0529 44



6500 28 +  
6500 29



6500 02 +  
6500 03



6500 10 +  
6500 11



0566 09

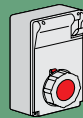

0566 34



0566 41



0566 74



0572 34



0589 18  
0572 99

\* MRP - Maximum Retail Price Inclusive of all taxes including GST.

Bold Cat.Nos are products normally available with Legrand (India) Stockists. Cat.Nos that are not bold - delivery within 4 - 8 weeks from the date of order. Bold packing quantity is our mandatory packing. Orders to be placed by Legrand (India) Stockist in multiples of the same.



# LEGRAND

## A GLOBAL EDIFICE

Legrand is global specialist in electrical and digital building infrastructures. The Group's headquarter is based at Limoges, France. Legrand (India), the pioneer of Miniature Circuit Breakers in India, is the Indian subsidiary of Legrand Group. The Group services the needs of residential, commercial, hospitality and industrial sectors.

- Manufacturing facilities in 90 countries and sale of products in 180 countries.
- World leader in wiring devices and cable management.
- The group designs and manufactures over 100 product families comprising of 3,00,000 products annually, with due emphasis on high performance, simplified installation and user convenience.
- Close to 1/3 of Legrand's capital expenditure is dedicated to the development of new products.
- Every year, Legrand invests around 4.8% of its global turnover on research and development activities involving over 2100 people worldwide.
- More than 100 showrooms around the globe.



Building trust with 36,700 employees



Sharing the legacy of over 6.1 billion euros turnover in the year 2020



Understanding you through 3,00,000 products



Partnering you with more than 4500 active patents

# LEGRAND

## GROUP VALUES



CUSTOMER  
AWARENESS



INNOVATION



RESOURCE  
ENHANCEMENT



ETHICAL  
BEHAVIOUR



# LEGRAND

## PRESTIGIOUS PROJECTS

- Some of the prestigious projects we have been proud to associate with.
- The group services the needs of residential, commercial, hospitality and industrial projects.

### NORTH



Atal Urja Bhawan,  
New Delhi

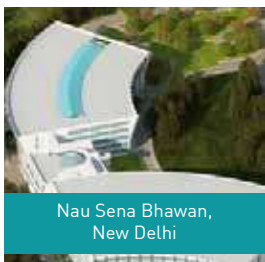

Nau Sena Bhawan,  
New Delhi

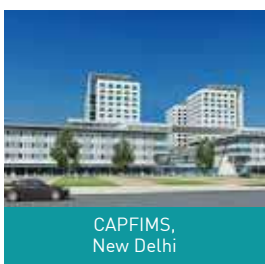

CAPFIMS,  
New Delhi



Ramaprastha City,  
Gurugram

### EAST



New Kolkata,  
Srirampur



DCPL Hotel,  
Kolkata



Indian Institute of Liver &  
Digestive Science,  
Kolkata

### WEST



Taj Vivanta,  
Navi Mumbai



Ushahkal Abhinav Hospital,  
Sangli



Al Jamea,  
Mumbai

### SOUTH



IIIT Trichy,  
Tiruchirappalli



Kamarajar Memorial,  
Puducherry

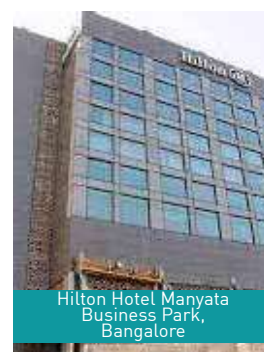

Hilton Hotel Manyata  
Business Park,  
Bangalore

### CENTRAL

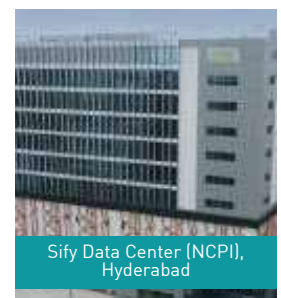

Sify Data Center (NCPI),  
Hyderabad

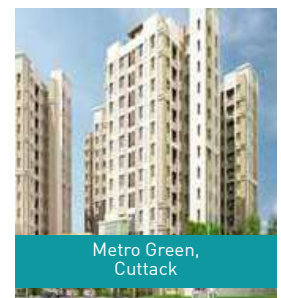

Metro Green,  
Cuttack

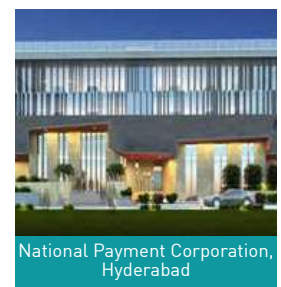

National Payment Corporation,  
Hyderabad



Yashoda Hospital,  
Hyderabad



## Warranty policy

Legrand warrants to the original purchaser that the Products (excluding any third party products purchased through Legrand, for which no warranties are made) will be free from defects in material and workmanship, under normal use and regular service, and preventative maintenance for a period of 18 months from the date of shipment or 12 months from the date of installation whichever is earlier. Should any failure to conform with this warranty be found during the Warranty Period, you must notify Legrand of your claim within thirty (30) days of discovery, and within the Warranty Period. Your failure to give notice of claims of breach of warranty within the Warranty Period shall be deemed an absolute and unconditional waiver of claims for such defects. Legrand will have no responsibility to honour claims received after the date the applicable Warranty Period expires. The invoice / bill in original must be produced without which warranty claim shall not be entertained.

### **This warranty does not cover the following:**

- Defect caused due to misuse, alteration, faulty installation, faulty electrical systems, negligent maintenance or misapplication of the product.
- Failure of product or components due to any act of nature; lightning strike, floods, hurricanes, tornadoes, etc. beyond the control of human being.
- Legrand does not warrant any third party products or associated hardware or their performance or suitability for use and application. Such items are provided "as-is".

### **Extended warranty policy is applicable for following products,**

1. DX<sup>3</sup> & RX<sup>3</sup> MCB – 5 years if mounted inside Legrand DB
2. Arteor™, Myrius NextGen™, Myrius™, Mylinc™, Lyncus™, Britzy™ switches (without neon lamp) & Power sockets – 10 years
3. Arteor™, Myrius NextGen™, Myrius™, Mylinc™, Lyncus™, Britzy™ other products – 2 years
4. Arteor IOT & Myrius Nextgen IOT - 2 years





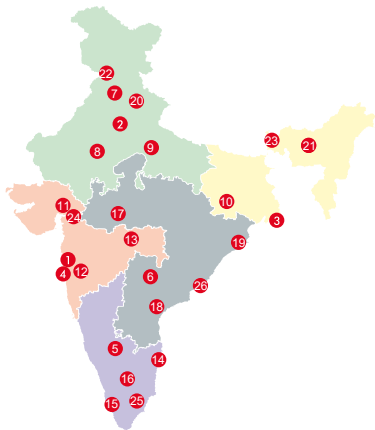

## Head offices

- 61 & 62, 6th Floor,  
Kalpataru Square, Kondivita Road,  
Off Andheri-Kurla Road, Andheri (E),  
**MUMBAI** – 400 059.  
Tel : (022) 3041 6200  
Fax : (022) 3041 6201  
Website : [www.legrand.co.in](http://www.legrand.co.in)

## Regional sales offices

- A-25, Mohan Co-operative  
Industrial Estate, Mathura Road,  
**NEW DELHI** – 110 044.  
Tel : (011) 3990 2200
- Bhakta Towers, 2nd & 3rd Floor,  
Plot No. KB 22, Sector-III, Saltlake,  
**KOLKATA** – 700 098.  
Tel : (033) 4021 3535
- C/203, Corporate Avenue, Atul Projects,  
Near Mirador Hotel, Chakala,  
Andheri Ghatkopar Link Road,  
Andheri – East, **MUMBAI** – 400 099.  
Tel : (022) 6230 1000
- Ferozes Manor, Situated at 58  
Hospital Road, Shivaji Nagar,  
**BANGALORE** – 560 001.  
Tel : (080) 80682 20000
- 205-208, 2nd Floor, Block - II, White  
House, Kundan Bagh, Begumpet,  
**HYDERABAD** – 500 016.  
Tel : (040) 4567 1717

## Branch offices

- Unit no.203, Tower B Bestech  
Business Towers, Sector 66, Mohali,  
**CHANDIGARH** – 160 017.  
Tele : (0172) 5019 008
- BLDG No-128, Mansarovar Link Road,  
Gopalpura Bypass, Mohan Nagar, Near  
Ridhi Sidhi Flyover **JAIPUR** – 302018  
Tel : 0141-2208665
- 209-A, 2nd Floor, Cyber Heights,  
Opp. Indira Gandhi Pratishthan,  
Vibhuti Khand, Gomti Nagar,  
**LUCKNOW** – 226 010.  
Tel : (0522) 431 9316
- 202 & 203, 2nd Floor, Sunrise, Forum  
100, Burdwan Compound, Lalpur,  
**RANCHI** – 834 001.
- A 101-102, Mondeal Heights,  
Besides Novotel Hotel, Sarkhej  
Gandhinagar Highway (S G Highway),  
**AHMEDABAD** – 380 015.  
Tel : (079) 6134 0555
- 8TH Floor, Pinnacle Park Avenue  
Opposite Law College, Law  
College Road Next To German  
Bakery, Shivaji Nagar  
**PUNE** – 411004.  
Tel : (020) 6729 5601 / 600
- Plot No.95, II Floor, Shreyash Heights,  
VIP Road, Ramdaspath,  
**NAGPUR** – 440 010.  
Tel : (0712) 2440 900
- 10 B, (10th Floor), Prestige Center Court,  
Office Block Vijaya Forum Mall, #183,  
N.S.K. Salai, Vadapalani  
**CHENNAI** – 600 026.  
Tel : (044) 6612 2800
- J. B. Manjooran Estate,  
Door No 50/1107A9, 3rd Floor,  
Bye Pass Junction, Edappally,  
**COCHIN** – 682 024.  
Tel : (0484) 6604 700
- B-5, 1st Floor, Thirumalai Towers,  
723, Avanashi Road,  
**COIMBATORE** – 641 018.  
Tel : (0422) 668 3200
- 204-205, Megapolis Square,  
579, M G Road,  
**INDORE** – 452 001.  
Tel : (0731) 4999 891
- MF-2, Datta's Lords House,  
Jammi Chettu Street, Mogalrajapuram,  
**VIJAYAWADA** – 520 010.  
Tel : (0866) 248 2393/6393
- Plot No. 359, Saheed Nagar,  
2nd Floor,  
**BHUBANESWAR** – 751 007.  
Tel : (0674) 254 0623
- Unit - 1 & 2, Vijay Park,  
Main Chakrata Road,  
**DEHRADUN** – 248 001.  
Uttarakhand.  
Tel : (0135) 661 6100
- House No. 97, Ground Floor,  
Rajgarh Main Road,  
Opp. City Heart Nursing Home,  
**GUWAHATI** – 781 007.

## Area offices

- Cabin No. 9, Second Floor,  
Madhok Trade Centre,  
Madhok Complex, Ferozpur Road,  
**LUDHIANA** – 141 001.  
Tel : (0161) 277 0301
- 94, Udham Singh Sarani,  
Ground Floor, Ashrampara,  
**SILIGURI** – 734 001.  
Tel : (353) 264 1067
- A-207, Universal Business  
Center, Near Madhuvan circle,  
L.P. Savani Road, Adajan,  
**SURAT** – 395 009.
- Aparna Towers, 1st Floor, 2/3,  
Bypass Road,  
**MADURAI** – 625 010.  
Telefax : (0452) 230 8414
- 43-9-205 3rd floor, plot no 10  
Subbalakshmi Nagar oppsite more  
super market  
**Visakhapatnam** -530026.  
Tel : (0891) 273 5652 / 2739363

## Technical assistance from Legrand

Telephonic technical assistance for selection of products, technical information, guidance, wiring diagrams and estimation is now made available to you at each Regional Office. Contact the Technical Officer of Legrand at the following telephone numbers

- New Delhi** : Tel.: (011) 2699 0028, 3990 2200  
**Kolkata** : Tel.: (033) 4021 3535 / 36  
**Mumbai** : Tel.: (022) 3385 6200  
**Chennai** : Tel.: (044) 3024 7200  
**Hyderabad** : Tel.: (040) 2341 4398 / 67, 4567 1717

For other places, contact the nearest  
Regional / Branch / Area offices

[customer.care@legrand.co.in](mailto:customer.care@legrand.co.in)

